

Rockfon[®] Module

Easily design and create ceiling layouts featuring linear lighting integrated with standard and custom ceiling panels.

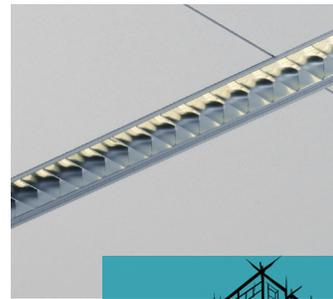

Rockfon Module – Stunning Design. Seamless Installation.

Easily combine our standard grid profiles, field panels, and specialty sized technical panels for seamless integration of linear light fixtures.

Visit rockfon.com or email techservices@rockfon.com today to discover how Rockfon Module can elevate design and simplify installation.



Inspirational Module Ceiling Layouts

A Modern Look for Every Space

The Rockfon Module system is ideal for any area that requires a clean, modern aesthetic. The use of our smooth or lightly textured, white Rockfon panels with one of our many grid profiles ensures a consistent, clean modern look.

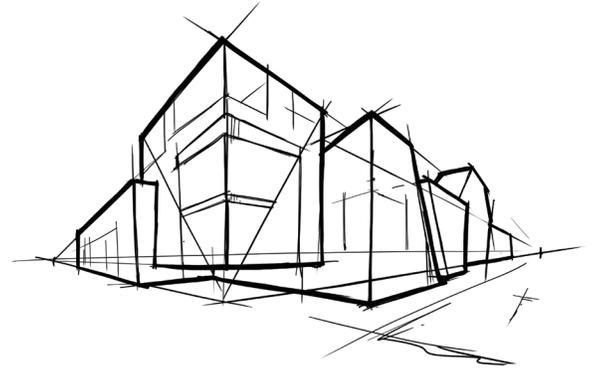

4" Module

- 4" Module Cross Tee
- 12" x 48" Module Technical Panel
- 4" x 48" Module Technical Panel
- Field perpendicular to Module



- 4" Module Cross Tee
- 12" x 48" Module Technical Panel
- 4" x 48" Module Technical Panel
- Field parallel to Module

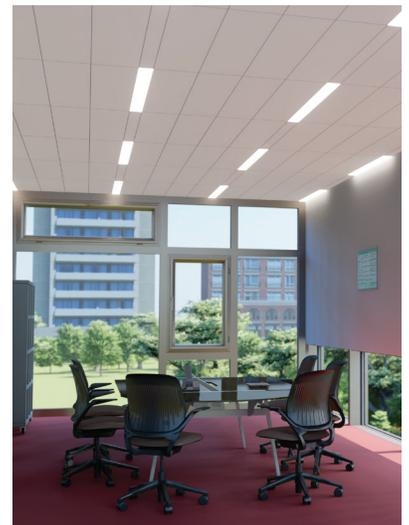

- 4" Module Cross Tee
- 24" x 24" Field Panels
- 4" x 48" Module Technical Panel



- 4" Module Cross Tee
- 24" x 48" Field Panels
- 4" x 48" Module Technical Panel
- Field perpendicular to Module



- 4" Module Cross Tee
- 24" x 48" Field Panels
- 4" x 48" Module Technical Panel
- Field parallel to Module

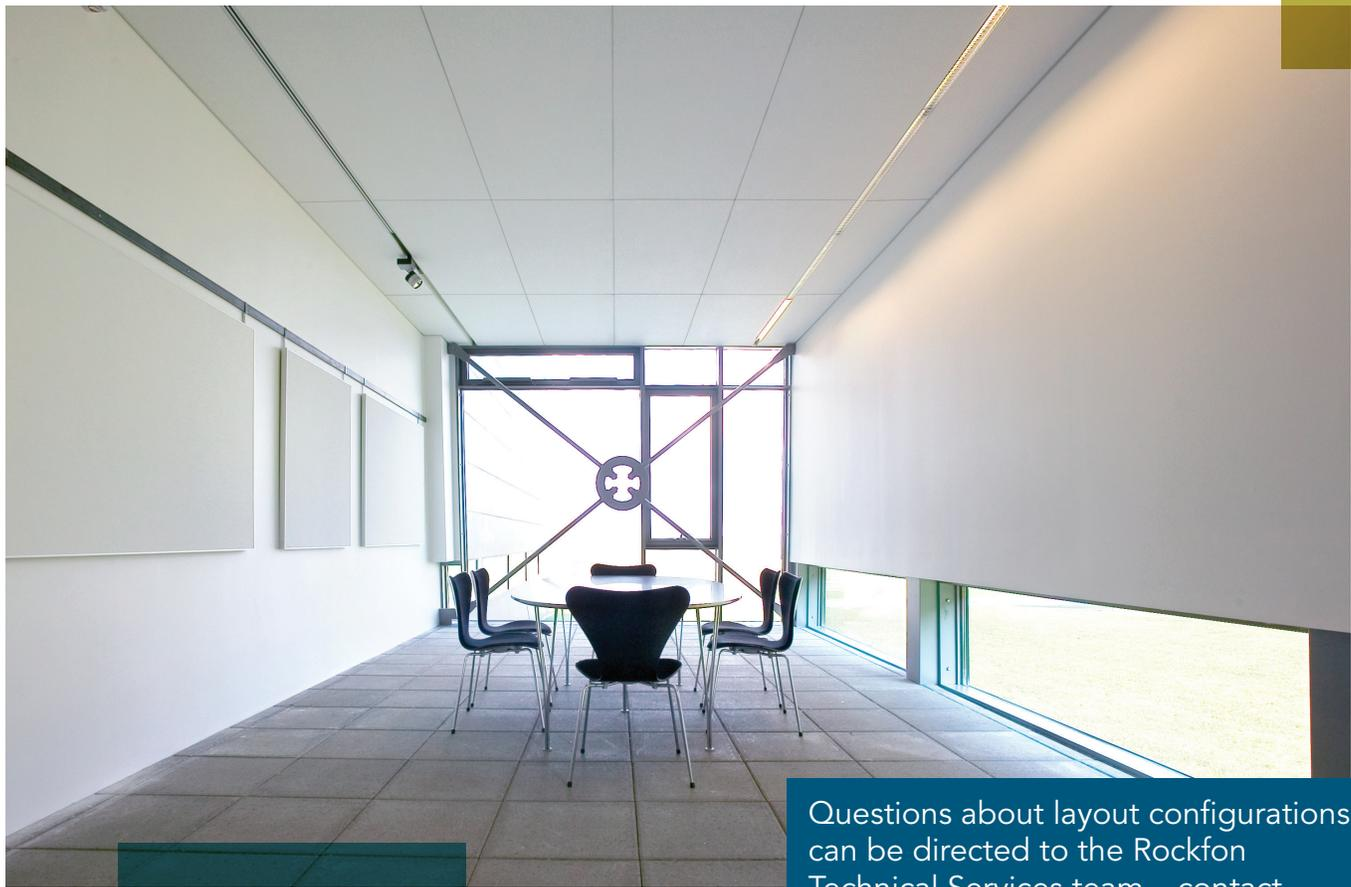
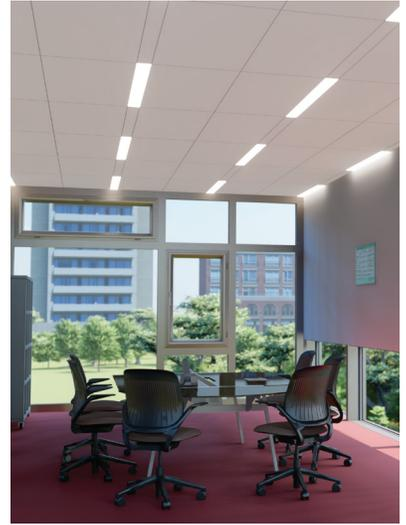

Questions about layout configurations can be directed to the Rockfon Technical Services team – contact techservices@rockfon.com

6" Module

- 6" Module Cross Tee
- 12" x 48" Module Technical Panel
- 6" x 48" Module Technical Panel
- Field perpendicular to Module



- 6" Module Cross Tee
- 12" x 48" Module Technical Panel
- 6" x 48" Module Technical Panel
- Field parallel to Module

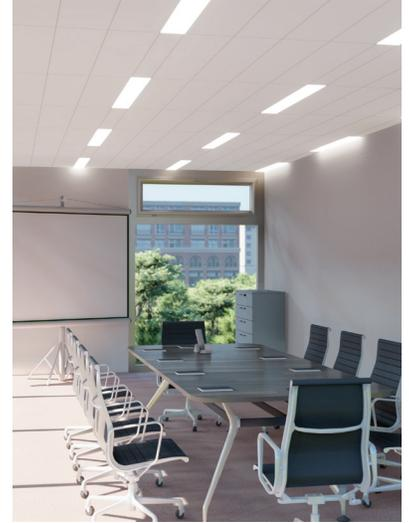

- 6" Module Cross Tee
- 24" x 24" Field Panels
- 6" x 48" Module Technical Panel



- 6" Module Cross Tee
- 24" x 48" Field Panels
- 6" x 48" Module Technical Panel
- Field perpendicular to Module



- 6" Module Cross Tee
- 24" x 48" Field Panels
- 6" x 48" Module Technical Panel
- Field parallel to Module



- Standard Grid Components
- 24" x 24" Field Panels
- 6" x 48" Module Technical Panel



Design Inspiration

For additional design inspiration, please reference our Staggered Pattern Layout Brochure.

Staggered Pattern

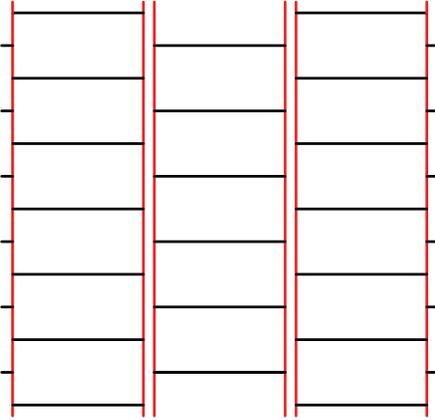

Running Basket Weave Pattern

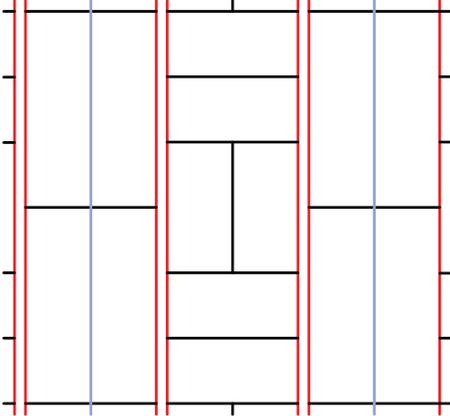

Brick Pattern

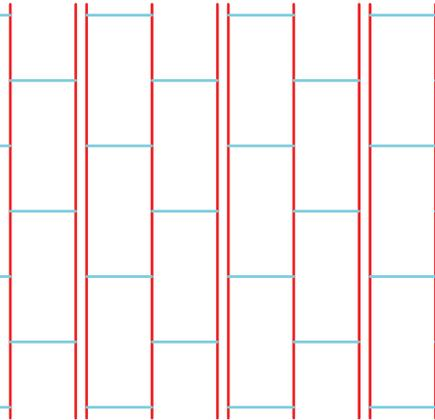

Check Pattern

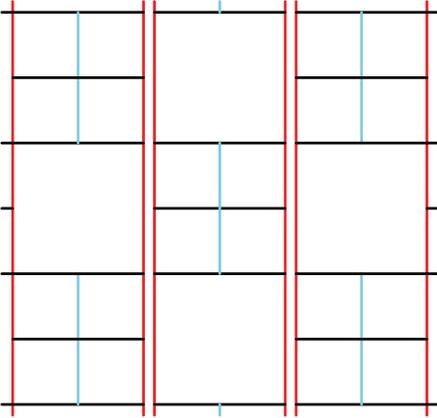

Basket Weave Pattern

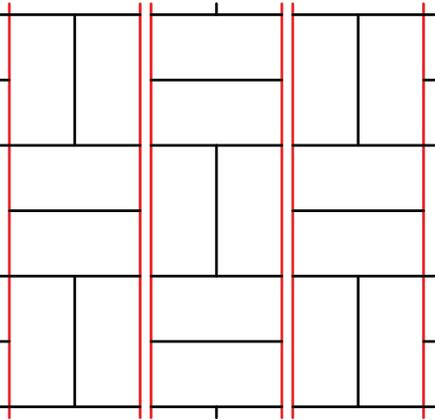

Rose Pattern

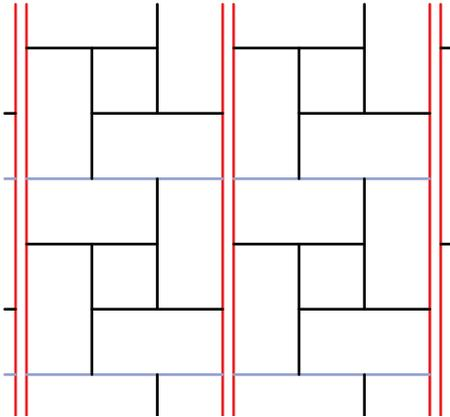

- Grid Key**
- 24" Cross tees
 - 48" Cross tees
 - 72" Cross tees
 - 12' Main runner



Questions about layout configurations can be directed to the Rockfon Technical Services team – contact techservices@rockfon.com

Rockfon Field and Module Technical Panel Options

Rockfon Sonar®, Alaska® and Tropic®

The Rockfon Module system is comprised of standard size field panels and specialty sized technical panels which integrate with designs featuring linear light fixtures. First, select the stone wool panel system that best fits your aesthetic and acoustic needs. Then select your edge type: tegular, concealed, or semi-concealed.

Tegular systems are comprised of all stone wool panels. Concealed and semi-concealed systems utilize stone wool field panels and metal module panels which are listed below listed below.

Ceiling Panel Options

Rockfon Sonar

- Elegant lightly-textured white surface
- High sound absorption (NRC = 0.90 - 0.95)
- High light reflectance (LR = 0.85)
- Available in the following panel sizes:
2' x 2' | 2' x 4' | 2' x 5' | 2' x 6' | 2' x 8'
- Module sizes available



Rockfon Alaska

- Elegant smooth white surface
- High sound absorption (NRC = 0.90)
- High light reflectance (LR = 0.86)
- Available in the following panel sizes:
2' x 2' | 2' x 4' | 2' x 5' | 2' x 6'
- Module sizes available



Rockfon Tropic

- Smooth white surface
- Good sound absorption (NRC = 0.85 - 0.90)
- High light reflectance (LR = 0.86)
- Available in the following field panel sizes:
2' x 2' | 2' x 4' | 20" x 60"
- Module sizes available

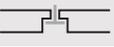

Lay-in Panels	Panel Size	Sonar®		Alaska®		Tropic®	
							
		15/16" Angled Tegular	9/16" Square Tegular Narrow	15/16" Angled Tegular	9/16" Square Tegular Narrow	15/16" Angled Tegular	9/16" Square Tegular Narrow
Field Panels	2' x 2'	16300	16200	10300	10200	1060	1020
	2' x 4'	16301	16201	10301	10201	1061	1021
	2' x 5'	16302	16202	10302	10202	–	–
	2' x 6'	16303	16203	10303	10203	–	–
	2' x 8'	16304	16204	–	–	–	–
Module Technical Panels	4" x 24"	16320	16220	10320	10220	1070	1030
	4" x 48"	16330	16230	10330	10230	1080	1040
	4" x 60"	16340	16240	10340	10240	–	–
	4" x 72"	16350	16250	10350	10250	–	–
	6" x 24"	16321	16221	10321	10221	1071	1031
	6" x 48"	16331	16231	10331	10231	1081	1041
	6" x 60"	16341	16241	10341	10241	–	–
	6" x 72"	16351	16251	10351	10251	–	–
	12" x 24"	16322	16222	10322	10222	1072	1032
	12" x 48"	16332	16232	10332	10232	1082	1042
	12" x 60"	16342	16242	10342	10242	–	–
12" x 72"	16352	16252	10352	10252	–	–	

For custom sized panels, contact Technical Services.

Rockfon Field and Module Technical Panel Options

Rockfon® Color-all™ Standard Program

- Smooth surface
- Excellent sound absorption (NRC = 0.85 – 0.95)
- Available in the following field panel sizes:
2' x 2' | 2' x 4'
- Module sizes available in Charcoal, Hemp, Stone and Concrete colors



709 Charcoal



723 Hemp



701 Stone



706 Concrete

Lay-in Panels	Panel Size	Color-all							
		15/16" Angled Tegular				9/16" Square Tegular Narrow			
Field Panels	2' x 2'	11250.XXX				11200.XXX			
	2' x 4'	11251.XXX				11201.XXX			
		Color-all (Charcoal)		Color-all (Hemp)		Color-all (Stone)		Color-all (Concrete)	
		15/16" Angled Tegular	9/16" Square Tegular Narrow	15/16" Angled Tegular	9/16" Square Tegular Narrow	15/16" Angled Tegular	9/16" Square Tegular Narrow	15/16" Angled Tegular	9/16" Square Tegular Narrow
Module Technical Panels	4" x 24"	11260.709	11210.709	11260.723	11210.723	11260.701	11210.701	11260.706	11210.706
	6" x 24"	11261.709	11211.709	11261.723	11211.723	11261.701	11211.701	11261.706	11211.706
	12" x 24"	11262.709	11212.709	11262.723	11212.723	11262.701	11212.701	11262.706	11212.706

For custom sized panels, contact Technical Services.

Rockfon Field and Module Technical Panel Options

Rockfon® Metal Module Panels for CDX/SCD

- 0.04" aluminum
- Install below the suspension
- Bendable locking tabs firmly hold the metal Module panels to the suspension system
- Custom Metal Module panel options available through Technical Services

Concealed	Panel Size					
		Sonar® CDX	Sonar® SCD	Alaska® CDX	Alaska® SCD	Color-all® CDX
Field Panels	2' x 2'	14600	14550	10600	10550	11600
	2' x 4'	14601	14551	10601	10551	11601
	2' x 5'	14602	14552	-	-	-
	2' x 6'	14603	14553	-	-	-
	2' x 8'	16604	16554	-	-	-
Metal Module Technical Panels* .040" Aluminum	4" x 24"	MDX04024	MDM04024	MDX04024	MDM04024	MDM04024
	4" x 48"	MDX04048	MDM04048	MDX04048	MDM04048	MDM04048
	6" x 24"	MDX06024	MDM06024	MDX06024	MDM06024	MDM06024
	6" x 48"	MDX06048	MDM06048	MDX06048	MDM06048	MDM06048
	12" x 24"	MDX12024	MDM12024	MDX12024	MDM12024	MDM12024
	12" x 48"	MDX12048	MDM12048	MDX12048	MDM12048	MDM12048

* Metal Module Panels are made to order. Custom colors and perforations available through Technical Services.

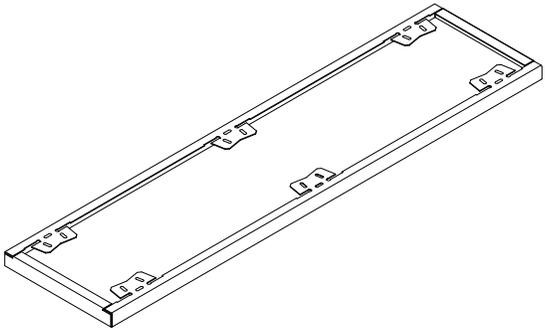
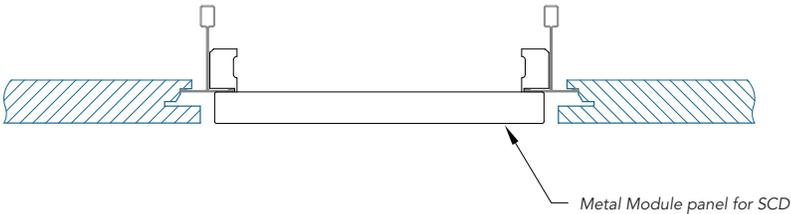

Chicago Metallic® Suspension System Options

Available Grid Options



Chicago Metallic®
1200 Seismic

Chicago Metallic®
4000 Tempra™

Chicago Metallic®
4200 Integrity™

Chicago Metallic®
4500 Ultraline™

Chicago Metallic®
4600 Tempra™

Face Width	15/16"	9/16"	9/16" Double Reveal	9/16"	9/16"
HD Main Runner Sizes					
144"	200.XXZ.01	4040.01CH	4200.01	4500.01	4630.01
Cross Tee Sizes					
4"	1211.01Z	4004.01Z	4211.01	-	-
6"	1212.01Z	4006.01Z	4212.01	-	-
24"	1202.01Z	4022.01CZ	4202.01	4512.01	4612.01
48"	1210.01Z	4014.01CZ	4204.01	4514.01	4614.01
60"	1207.01H	4015.01CH	4205.01	4515.01	4615.01
72"	1236.01H	4017.01CH	4206.01	4516.01	4616.01
96"	1278.01H	4018.01CH	4208.01	4528.01	4628.01

* Custom slotted main runners are available for each system. Requests can be directed to the Rockfon Technical Services team - contact techservices@rockfon.com
Reference the grid system datasheets for a full list of suspension components and details.

For product numbers and more information visit rockfon.com



Module System Perimeter Details

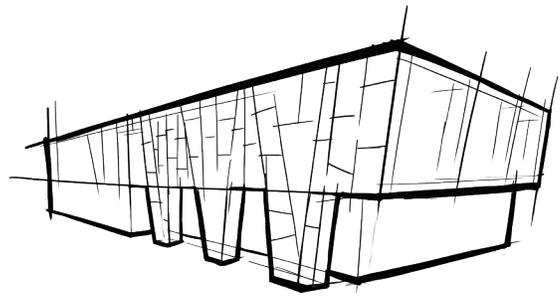

Hemmed Edge Wall Angles

Product Number	Nominal Dimensions		
	Face Width	Height	Length
1420.01	15/16"	15/16"	12'
1425.01	2"	2"	12'
1480.01	9/16"	15/16"	12'
1454.01	15/16"	-	10'



1420



1425



1480



1454

Hemmed Edge Shadow Line Moldings

Product Number	Nominal Dimensions		
	Flanges	Recess	Length
1468.01	3/4" x 15/16"	3/8" x 3/8"	10'
1469.01	9/16" x 15/16"	3/8" x 3/8"	10'



1468



1469

Rockfon Infinity™ Perimeter Trim

Perimeter Trim

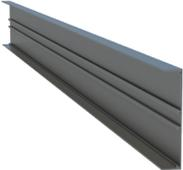

Infinity™



Infinity™ R
(Reveal)

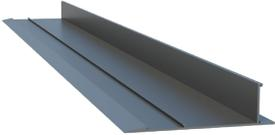

Infinity™ Z
(Razor Edge)

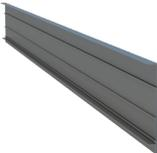

Infinity™
CDX/SCD

For product numbers and more information visit rockfon.com

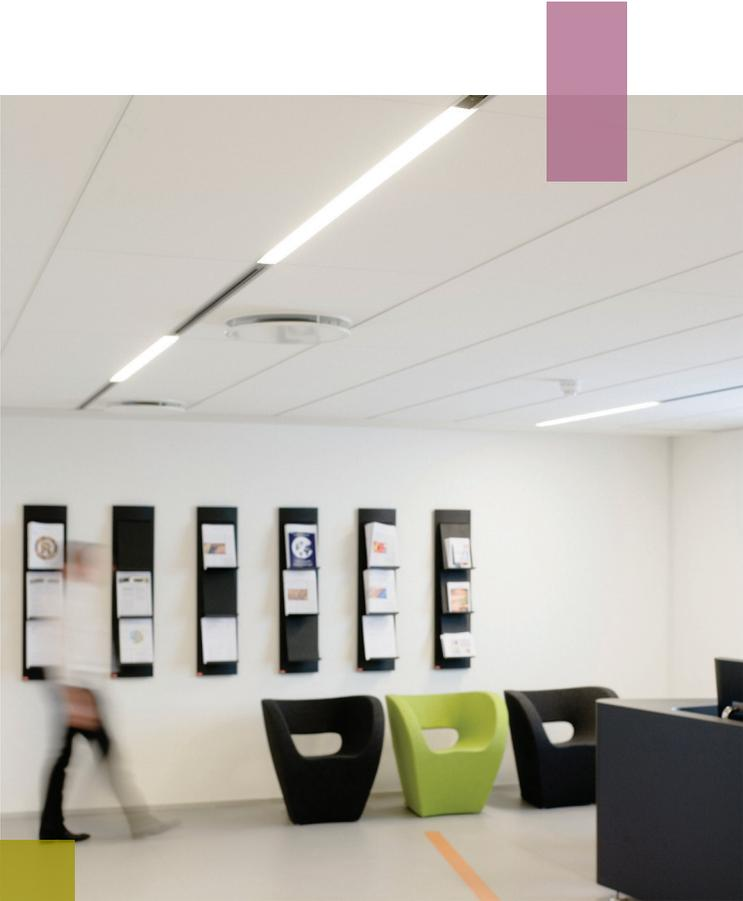

Module System Accessories

Clips

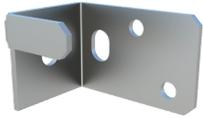

1493.00
Unopposed Tee Clip

Enhance your design with the ability to create code-compliant staggered pattern layouts. This clip should be used at light fixture locations.



479.00
90 Degree Corner Clip

Increase the stability of your layouts with single cross tee connections.



1496.00
Seismic Perimeter Clip

Add additional seismic security to your system.



935.00
Hold Down Clip for
Various Panel Heights

Enable uplift resistance for field and technical panels.



490.00
Hold Down Clip Ideal
for 0" – 3/4" Panels

Enable uplift resistance for field and technical panels.



491.00
Hold Down Clip Ideal
for 3/4" – 1-1/4" Panels

Enable uplift resistance for field and technical panels.



MDY4.00
4" Yoke

Compatible with 4" light fixtures*



MDY6.00
6" Yoke

Compatible with 6" light fixtures*

* For custom sized yokes, please contact Technical Services.

To Learn More

Please visit rockfon.com, email techservices@rockfon.com or call **800-323-7164**.

Rockfon® is a registered trademark
of ROCKWOOL Group.

2023 | Subject to alterations in range and product technology without prior notice. Rockfon accepts no responsibility for printing errors.
© ROCKWOOL A/S 2022. All rights reserved.® denotes a trademark that is registered in the United States of America.



Rockfon
4849 S. Austin Ave.
Chicago, IL 60638 USA

Tel. +1-800-323-7164
cs@rockfon.com
rockfon.com