

# Rockfon<sup>®</sup> System VertiQ<sup>®</sup> T24 A Wall<sup>™</sup>

## System Description



### Visible profile wall system

- Wall lining element for acoustic corrections
- Available in 4 standard colours
- Specifically developed system making installation fast and easy
- Every single panel is demountable

## Description

**Rockfon System VertiQ T24 A Wall** consists of 40 mm thick Rockfon® VertiQ® A24 wall panels. It is installed using J-channel and standard 38 mm deep T24 cross tees and intermediate profiles are fastened directly to the wall using T fixing brackets and supporting brackets (when needed).

Rockfon VertiQ A24 panels have a durable woven surface and are available in 4 colours (white, grey, light grey and black). The panels of Rockfon System VertiQ T24 A Wall are easily demountable.

### Restrictions

Rockfon System VertiQ T24 A Wall is not an impact resistant wall solution. Rockfon VertiQ A panels have superior impact resistance, however they are not recommended in areas subjected to regular impact.

Rockfon System VertiQ T24 A Wall is not recommended in swimming pools due to the risk of corrosion.

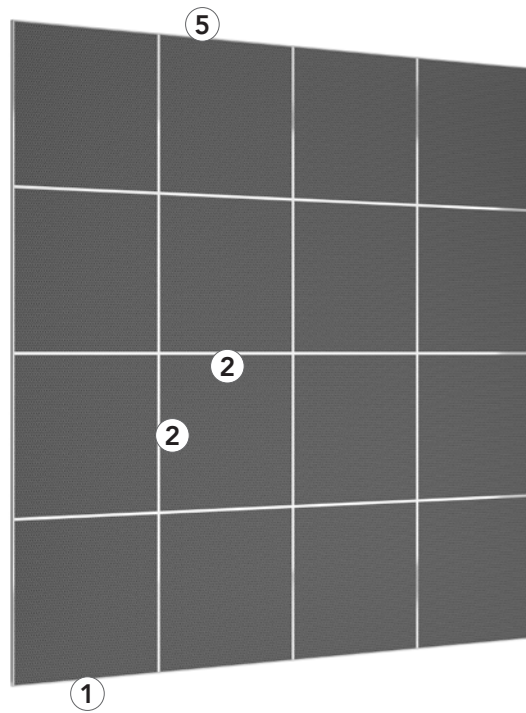

T-fixing bracket are fastened directly to the wall.

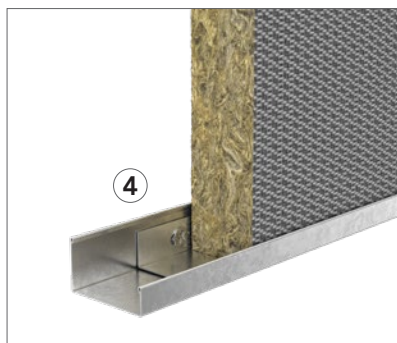

The 40 mm J-channel (25/40/13 mm) and the supporting bracket to support the bottom of the panels mounted at multiple heights or off the floor.

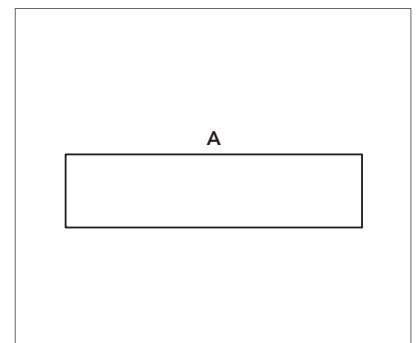

A-edge.

## System components and installation guide

Following quantities are in pieces per panel:

Panel dimension (mm)	Panel orientation	Supporting brackets (off-floor/baseboard or multi-panel height installations only)	T fixing brackets, horizontal	T fixing brackets, vertical
2700 x 1200	Vertical	2: 400 mm in from both the left and right edges	0 with a single-panel height installation, 2 at each additional panel junction: 300 mm in from both the left and right edges	0 with a single-panel wide installation, 2 at each additional panel junction: 600 mm in from both the top and bottom edges
2700 x 1200	Horizontal	3: 400 mm in from both the left and right edges, one at the panel-centre	0 with a single-panel height installation, 2 at each additional panel junction: 600 mm in from both the left and right edges	0 with a single-panel wide installation, 1 at each additional panel junction: 600 mm in from both the top and bottom edges (panel-centre)
1200 x 1200		1: 600 mm in from both the left and right edges (panel-centre)	0 with a single-panel height installation, 2 at each additional panel junction: 300 mm in from both the left and right edges	0 with a single-panel wide installation, 1 at each additional panel junction: 600 mm in from both top and bottom edges (panel-centre)

Installation of Rockfon VertiQ panels should only be done using components supplied by Rockfon. Components are sold separately. Failure to follow these instructions will void any warranty.

### Panel - A-edge

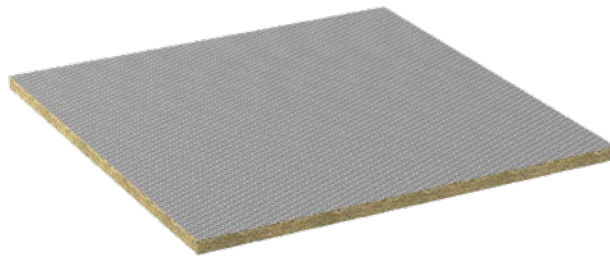

### Chicago Metallic™ T24 3830 + J-Channel

1. J-Channel



2. Intermediate profile main runner



### Accessories

3. T fixing bracket



4. Supporting bracket



5. SMF clip

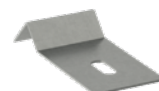

## Performance



### Corrosion resistance

Class B (EN13964)



### Demountability

Panels installed in Rockfon System VertiQ T24 A Wall are fully demountable.



### Impact resistance

Rockfon System VertiQ T24 A Wall is not an impact resistant wall solution.

The Rockfon VertiQ A panels have superior impact resistance however they are not recommended in areas subjected to regular impact. The woven surface of Rockfon VertiQ panels provides enhanced resistance to perforation, tested in accordance with NF P 08-301.

## Compatible Panels Overview

All Rockfon A-edge panels available in dimensions mentioned below can be installed in Rockfon System VertiQ T24 A Wall.

		Dimensions (mm)				
Tiles	Thickness (mm)	1200 x 600	1200 x 1200	1800 x 600	2400 x 600	2700 x 1200
Rockfon® VertiQ®	40		•			•
Rockfon Samson® Wall	40	•	•	•	•	

## Grid Installation

### Grid layout

Rockfon VertiQ A edge panels can be installed in Rockfon System VertiQ T24 Wall. Some layout options are shown below depending on the size of the panel.

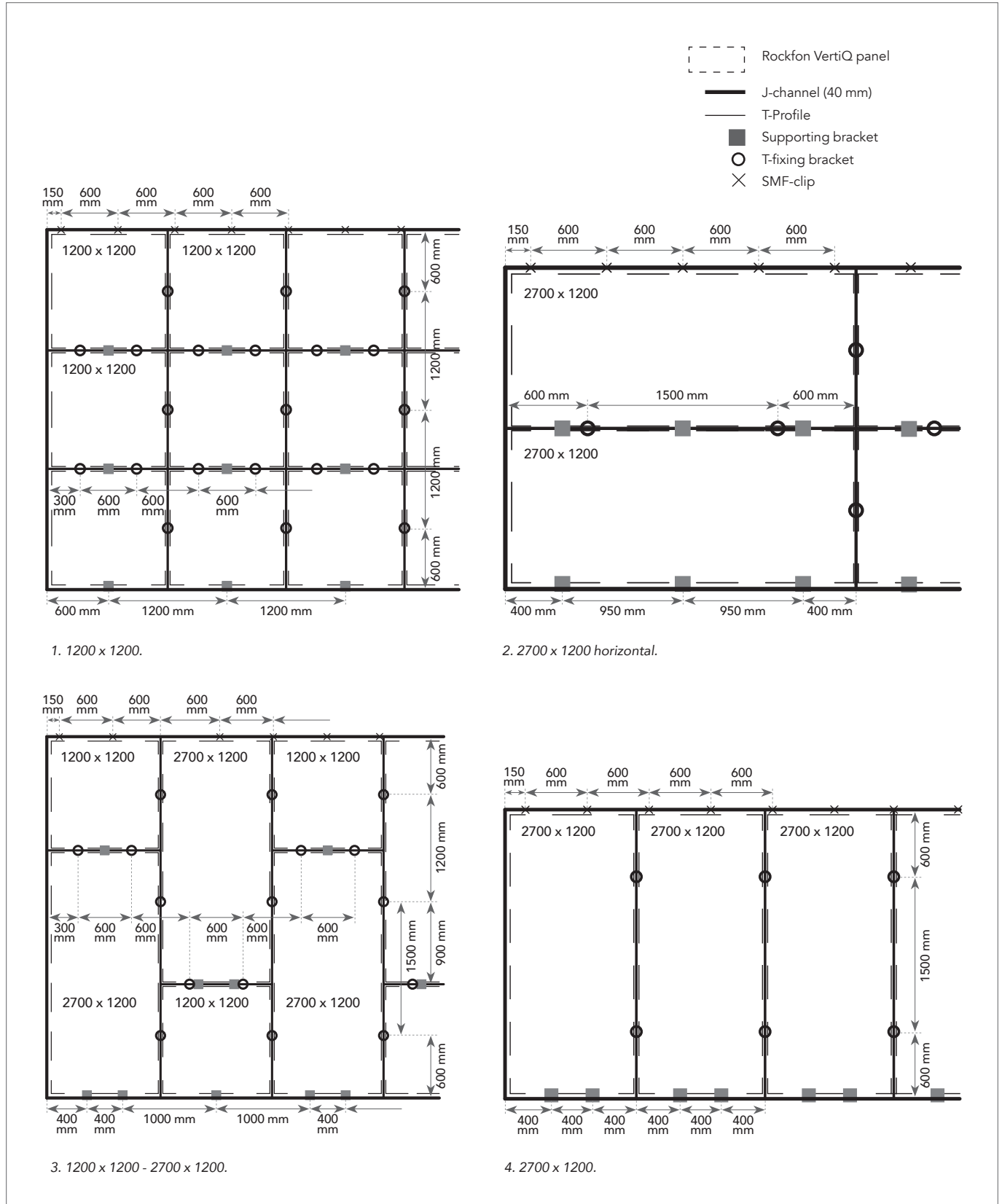

### Installation requirements

During and after the grid installation, it is important to check that the T profiles are perfectly aligned horizontally. A maximum level difference of +/- 1 mm is recommended between the profiles. This tolerance is valid for all directions. Use mounting screws/methods appropriate for the wall material. Ensure that the wall is smooth and level. Any levelling correction must be done before any installation begins.

40 mm deep J-channel and 38 mm deep T24 tees as intermediate vertical and horizontal profiles are used. J-channel are fastened with screws, together with SMF clips where needed. For multiple-panel installations, both horizontal and vertical T24 intermediate profiles clip into place using T fixing brackets mounted directly to the wall. Supporting brackets are also required for multiple-height or off-floor/baseboard installations. Total installation depth is 43 mm.

The bottom J-channel, which is used for multiple-height installations, rests on the floor or baseboard. Use a M-4 mm measure between the bottom J-channel and first horizontal T24 intermediate profiles. This ensures that the Rockfon VertiQ top edges are properly covered by the T24 front capping. All further vertical levels will use standard M measure distance.

Supporting bracket – these provide the required support to the panels within a multiple height or off-floor/baseboard installation. They are mounted so the underside is 4 mm above the module axis line (which the T fixing bracket channels are centred on) so the panels can rest upon them (see the diagram on page 6).

SMF clip – for use when the top J-channel needs to be installed last, offering demountability.

## Minimum installation depth (mm)

Panels mounted in Rockfon System VertiQ T24 A Wall give full demountability.

The installation depth is defined as the distance from the front side of the panel to the wall substrate. D represents the exact installation depth that allows for easy panel installation and demounting.

Thickness	Dimensions	D
mm		
40	2700 x 1200	43
	1200 x 1200	

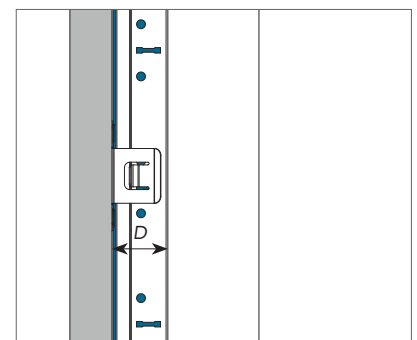

### Single-panel high solutions

1. Top J-channel fixed, wide-side, to the wall with a SMF clip.  
A min. 14 mm distance to the ceiling should remain.

Insert the top J-channel into the SMF clips, then lift it up 14 mm to allow the top edge of the panel to fit in. When all the panels are in place, the top J-channel slides back down to cover the top edges. Vertical T24 intermediate profiles clicked into T fixing brackets should be installed before lowering the top J-channel.

2. Top J-channel fixed narrow-side to the wall with SMF clip.  
They can be mounted directly under the ceiling.

Insert the top J-channel into the SMF clips, then the top edge of the Rockfon VertiQ panel into the top J-channel so the bottom edge can pass over and set down into the bottom J-channel. Vertical T24 intermediate profiles are installed as the final step using the same motion as used for the panels.

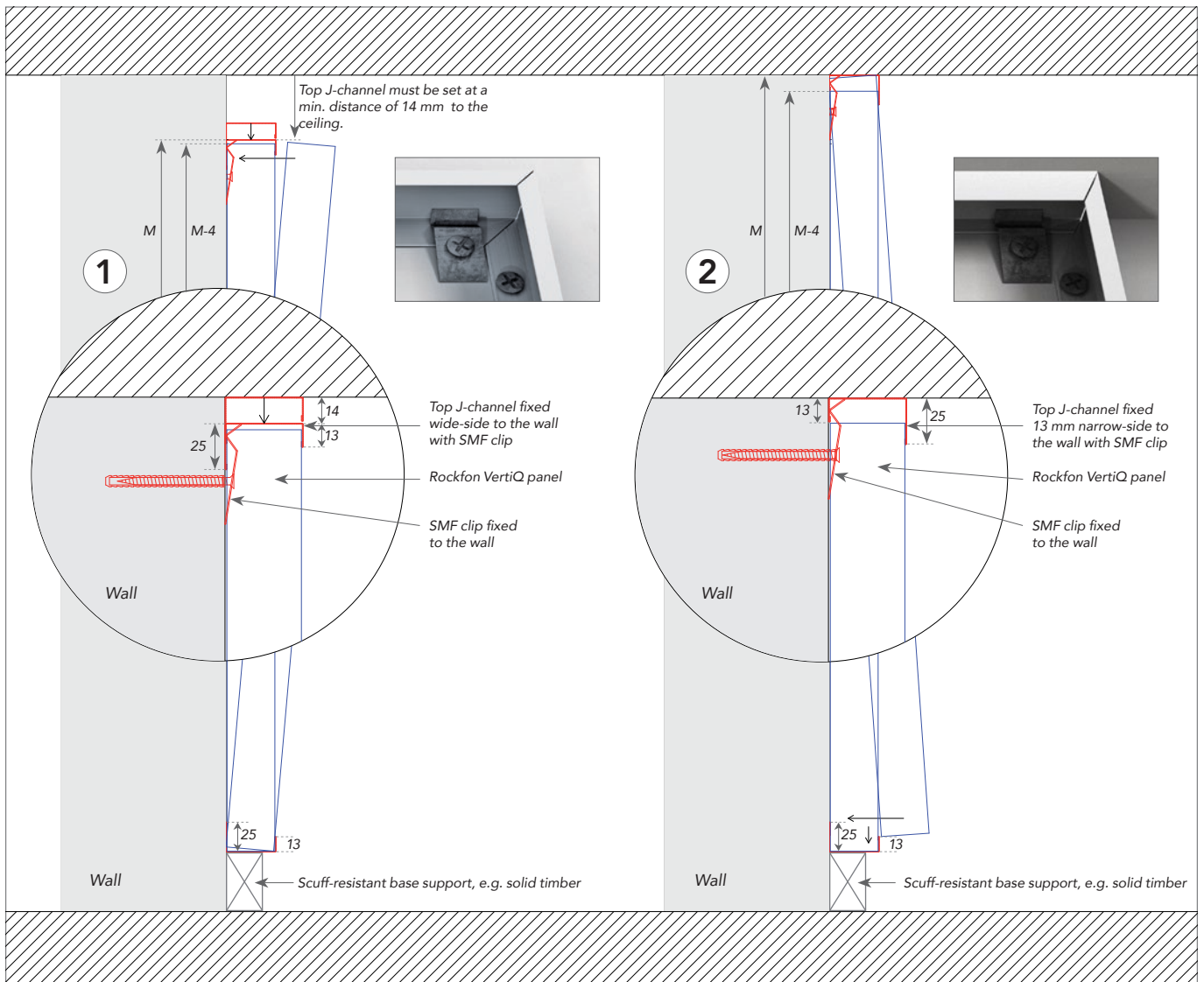

### Bottom J-channel

1. Supported by a scuff-resistant base support.
2. Unsupported, above the floor, with supporting brackets inside.
3. Supported by the floor.

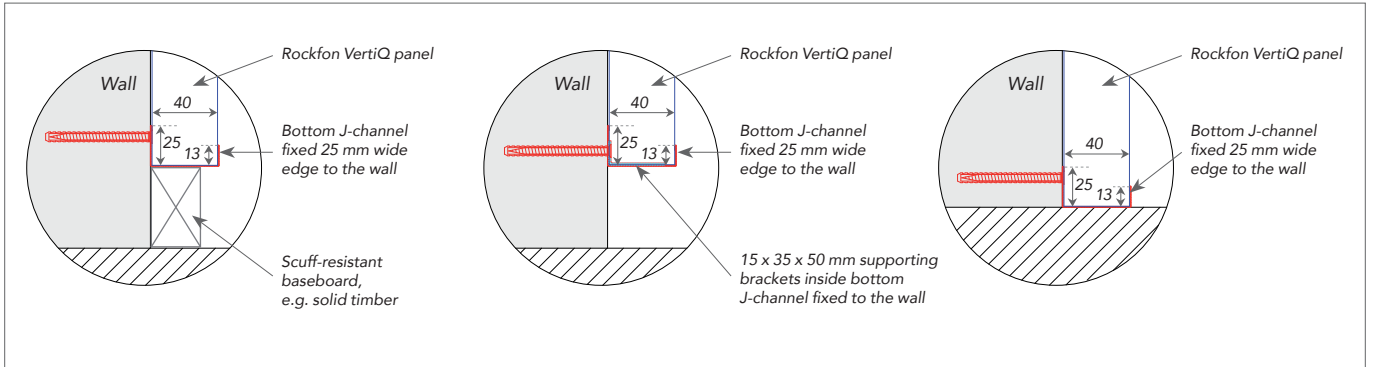



Multi-panel high solutions

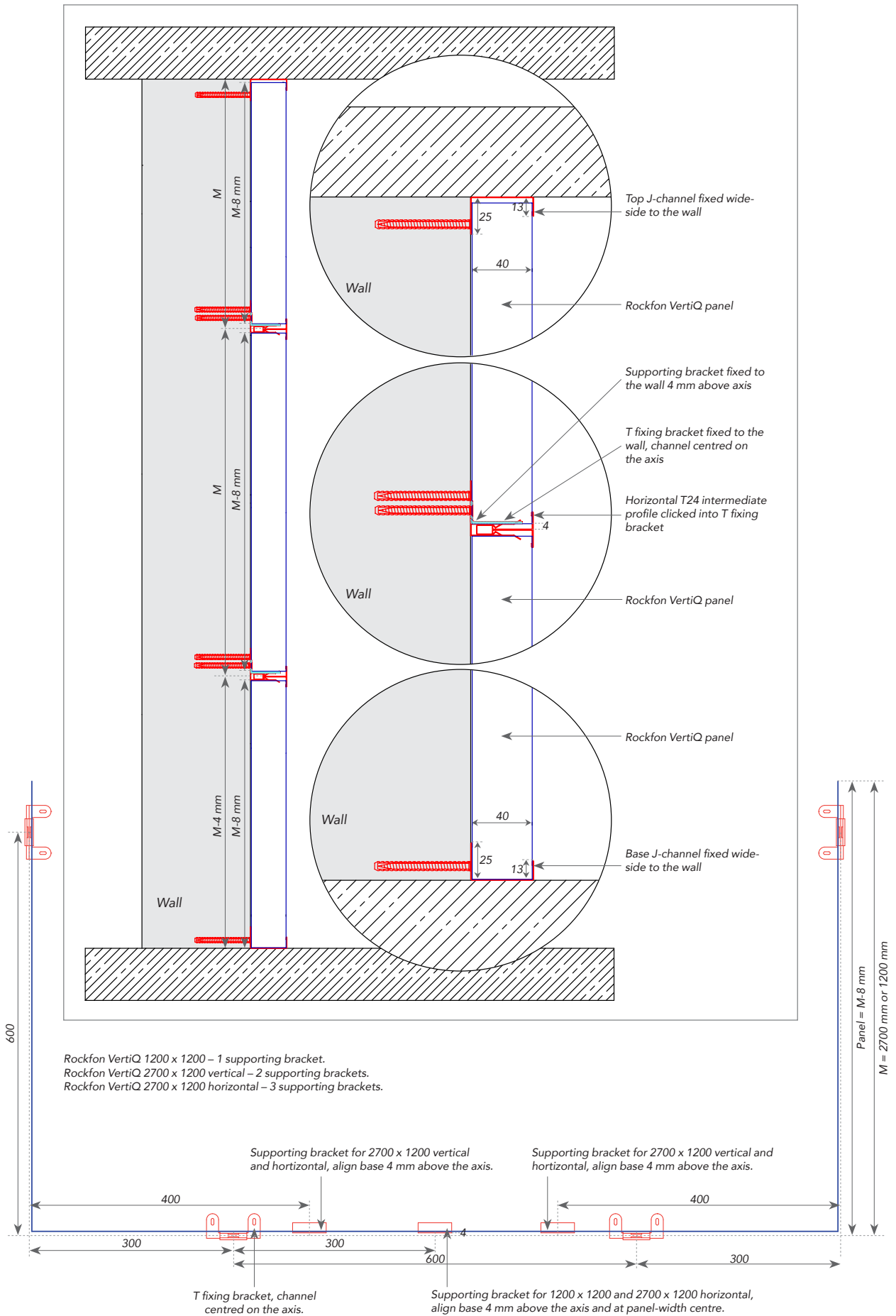

## 1. J-channel

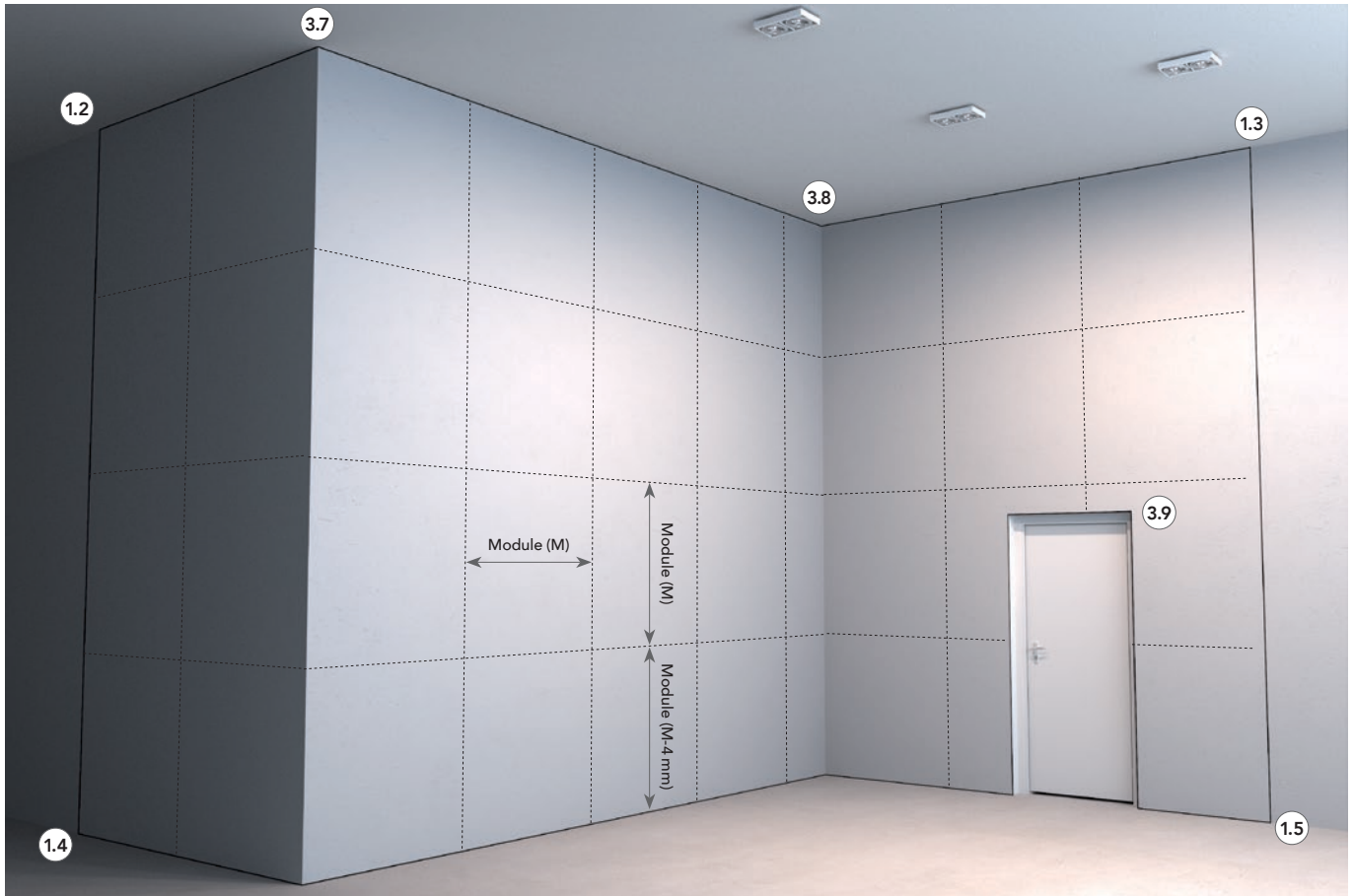

1.1 Mark out all the axes for J-channels and intermediate profiles at Module (M) measures. For the bottom row of panels, use M-4 mm up from the bottom J-channel.

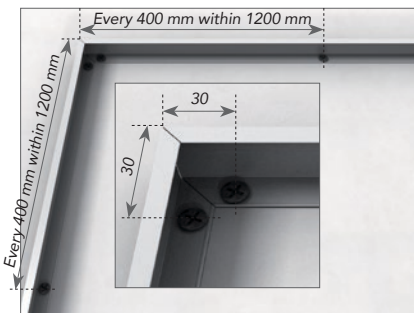

1.2 Top and side J-channels affixed with a 25 mm wide edge to the wall.

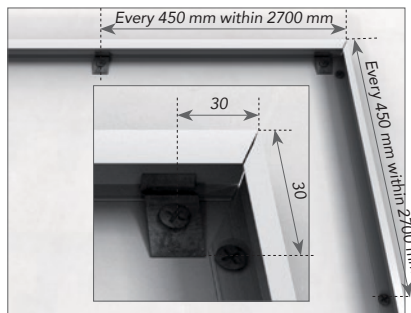

1.3 Side J-channel affixed with a 25 mm wide edge to the wall. The top J-channel affixed with a 13 mm narrow edge to the wall using a SMF clip. This method allows for demounting of the top trim.

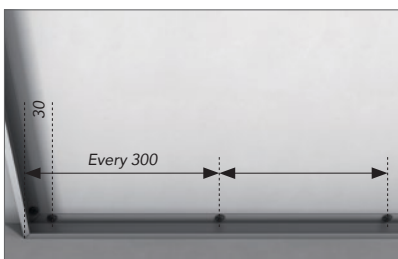

1.4 The bottom J-channel rests on the floor or another solid base support material.

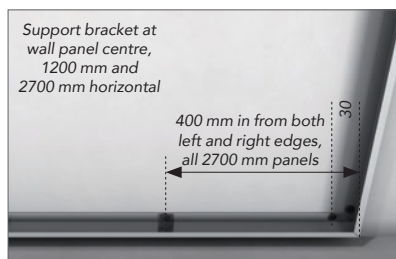

1.5 Bottom J-channel floats above the floor, requiring the use of supporting brackets.

### Important

- Use mounting screws/methods appropriate for the wall material.
- Use a sharp-bladed saw to carefully achieve neat corner joints.
- Placing an internal support, e.g. 40 mm thick wood block, inside the J-channel will reduce bending / damage when cutting.
- Use supporting brackets to support multi-height installation panels and bottom J-channel not resting on the floor/base support.

For off-floor installations, consideration should be given to using a scuff-resistant skirting or base support between the floor and bottom J-channel. This will reduce the likelihood of damage from shoes, luggage, vacuum cleaners or other floor-level risks and help avoid ball or human contact with any low-lying J-channel corners.

## 2. T fixing brackets and supporting brackets

T fixing brackets and supporting brackets are required to:

- Prevent accidental removal of intermediate profiles.
- Provide enough support for each panel separately in multiple-height installations.
- Make a secure yet demountable installation – intermediate profiles can be removed from their T fixing brackets, as long as their positions are known.

Remember to follow recommended guidelines for quantity and positioning of both T fixing brackets and supporting brackets.

### Important

Creating a demountable solution depends on knowing where all the T fixing brackets are located after installation is completed. An installation diagram clearly showing the positions of all T fixing brackets should be made and archived. This will enable easy location of these components for any subsequent maintenance.

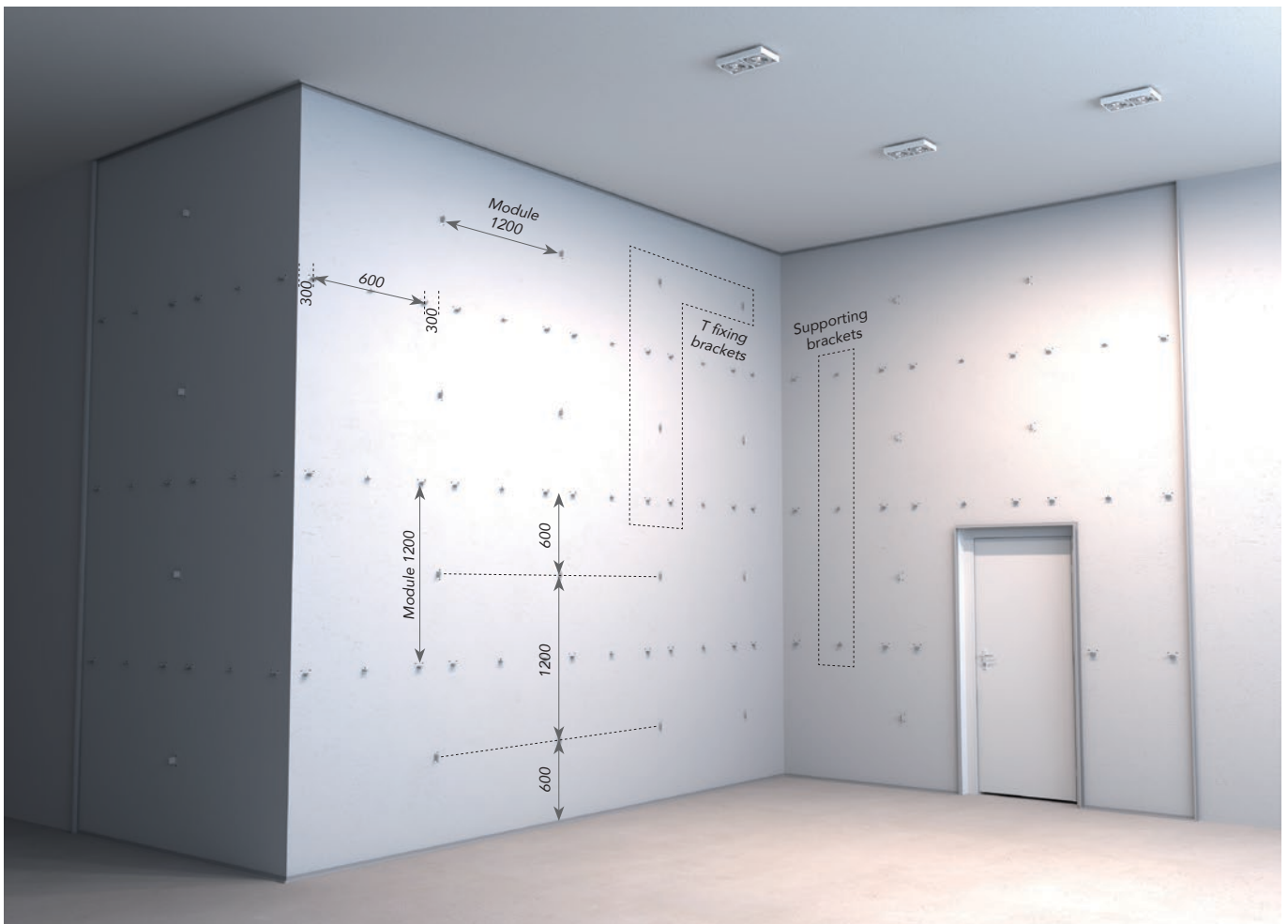

2.1 Placement of all T fixing brackets and supporting brackets should be measured out and mounted before any panel installation begins. Doing so will greatly reduce installation time. Ensure that all brackets line up – T fixing brackets' channel on the module axis, supporting brackets' underside 4 mm above it.



### 3. Wall panels

These instructions cover both single and multiple-height installations. For multiple-height installations, the terms 'upper' and 'lower' refer respectively to the uppermost and lowermost panels.

Start installing Rockfon VertiQ wall panels working inward from the outside / perimeter panels, both left and right. Ensure that all outside / perimeter panel edges are securely under their J-channels.

As outside / perimeter panels are installed, cover their horizontal joints with 38 mm deep tees cut to exactly M-12 mm (see diagram on page 14). This secures the panel enough to continue safely working inward.

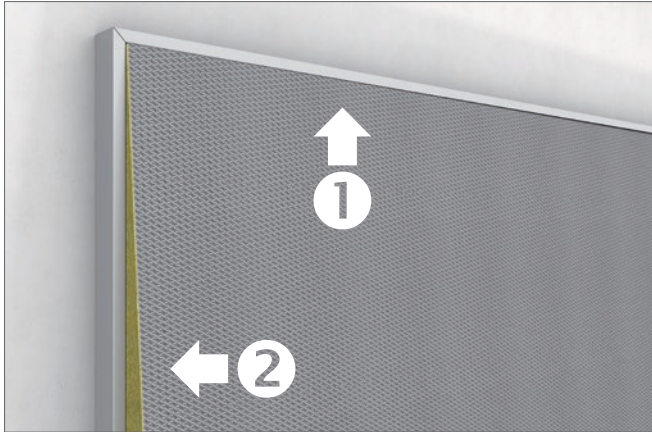

3.1 Angle an 'upper' panel into the top J-channel, then flat against the wall. Ensure there is sufficient trim overlapping the panel top, then slide it carefully into the vertical J-channel.

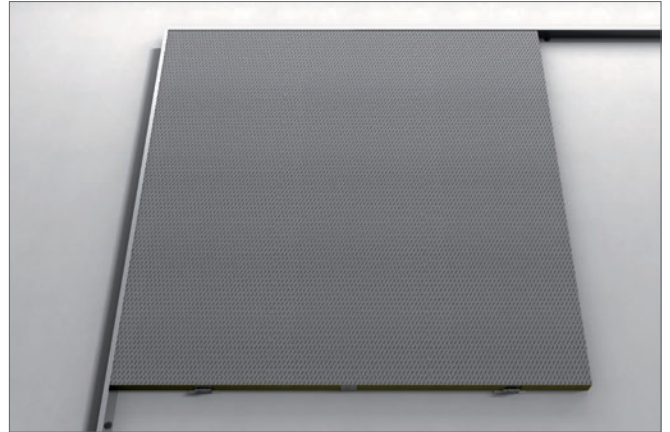

3.2 The bottom of all multiple-height installation panels should rest securely on their supporting bracket(s) – see diagram on page 9.

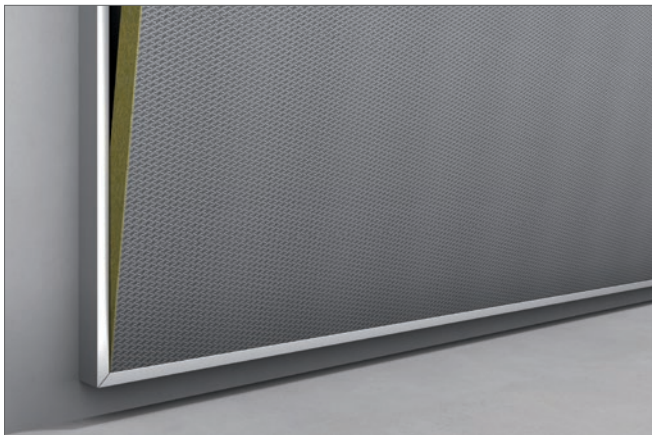

3.3 Angle a 'lower' panel into the bottom J-channel, then flat against the wall. Slide it carefully into the vertical J-channel.

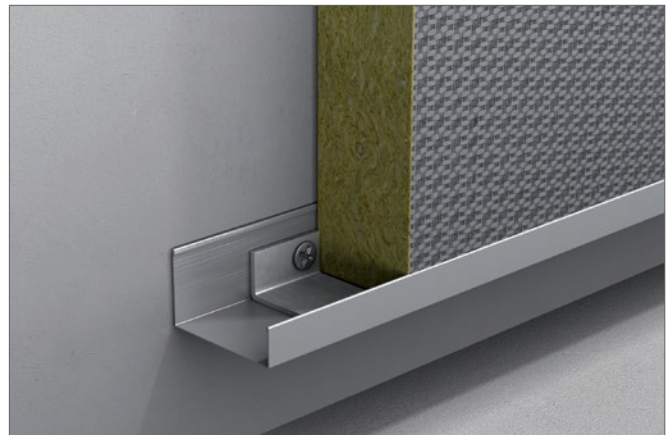

3.4 When required, remember to use supporting brackets mounted inside the bottom J-channel.

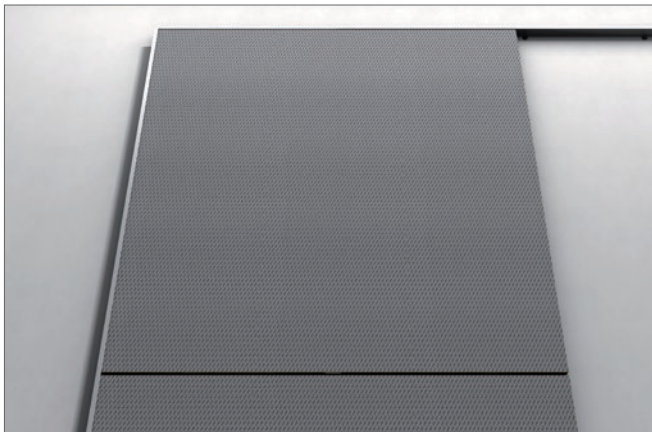

3.5 Install any intermediate panels, working from the uppermost to lowermost side of the panel. They should sit securely in place via supporting bracket(s) and the J-channel – see diagram on page 6.

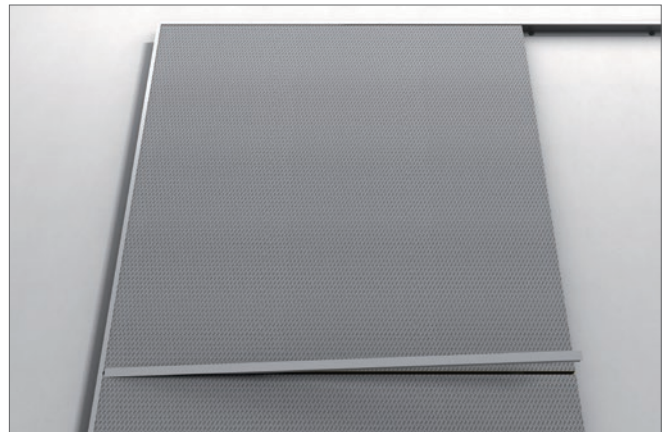

3.6 Cover the horizontal joints between panels by clicking T24 profiles into the T fixing brackets, then slide it carefully under the J-channel edge. These horizontal tees must be cut to an exact dimension of M-12 mm.

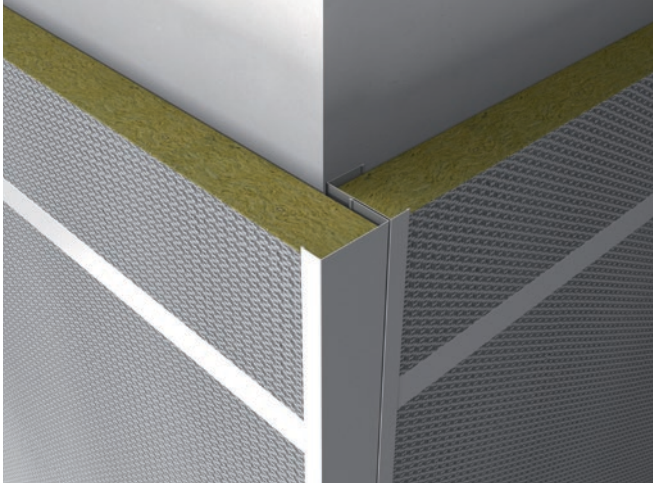

3.7 External corner – two vertical J-channels are fastened to each other every 300 mm and 30 mm from each end. Also, every 300 mm the wall-mounted J-channel is fixed with the 25 mm wide-edge to the wall.

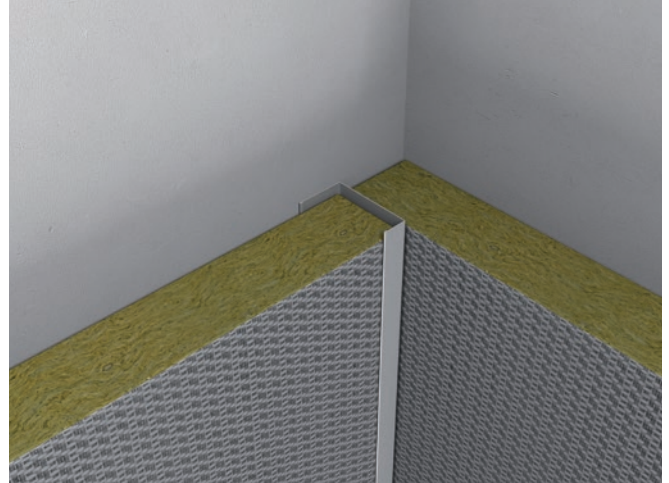

3.8 Internal corner – one vertical J-channel is mounted at a distance of 40 mm from the corner, where a 25 mm wide-edge is affixed to the wall every 300 mm. This allows a Rockfon VertiQ panel to slide into the corner behind it.



3.9 J-channel finishing around a door or window should always be done with J-channel mounted with a 25 mm wide-edge to the wall, affixed every 300 mm and 30 mm from all ends. To minimize panel waste, measure and cut carefully while ensuring adequate J-channel overlap.



3.10 Cover all remaining horizontal joints between panels by clicking T24 profiles into the T fixing brackets. Horizontal profiles should be cut to an exact dimension of M-12 mm. Ensure the outer ends of the horizontal tees are covered by the J-channels.



3.11 Install all remaining intermediate panels as described on page 9, working from the top downwards. During installation, cover all horizontal joints with T24 profiles by clicking them into the T fixing brackets. When the entire installation is fitted with Rockfon VertiQ panels, the final step is covering all the vertical joints with long tees clicked into T fixing brackets (see next section).

### Important

The standard locking connectors at each end of a T24 profile are not needed when installing Rockfon VertiQ A24 in Rockfon System T. Do not include them in any measurements, simply cut them off.



#### 4. Vertical intermediate profiles

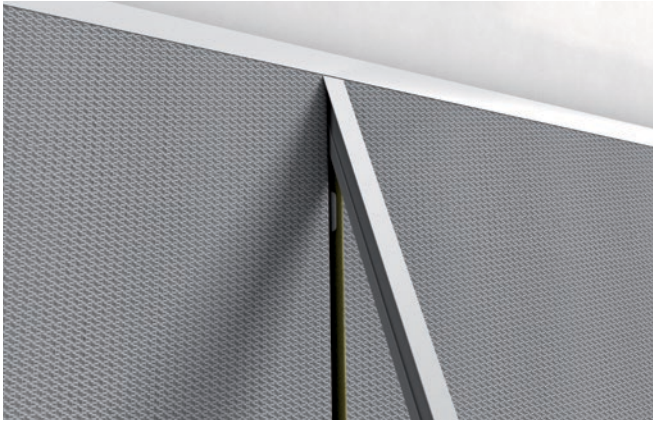

4.1 When the entire surface is covered with wall panels, cover all the vertical joints with long T24 profiles clicked into the T fixing brackets. These vertical tees must be cut to an exact length of  $M-12\text{ mm}$ , where  $M$  is the installation height. Ensure the ends of all horizontal tees are covered by the vertical tees, and that both ends of the vertical tees are sufficiently covered by the top and bottom J-channels. Use additional T fixing brackets to connect vertical profile extensions when required.

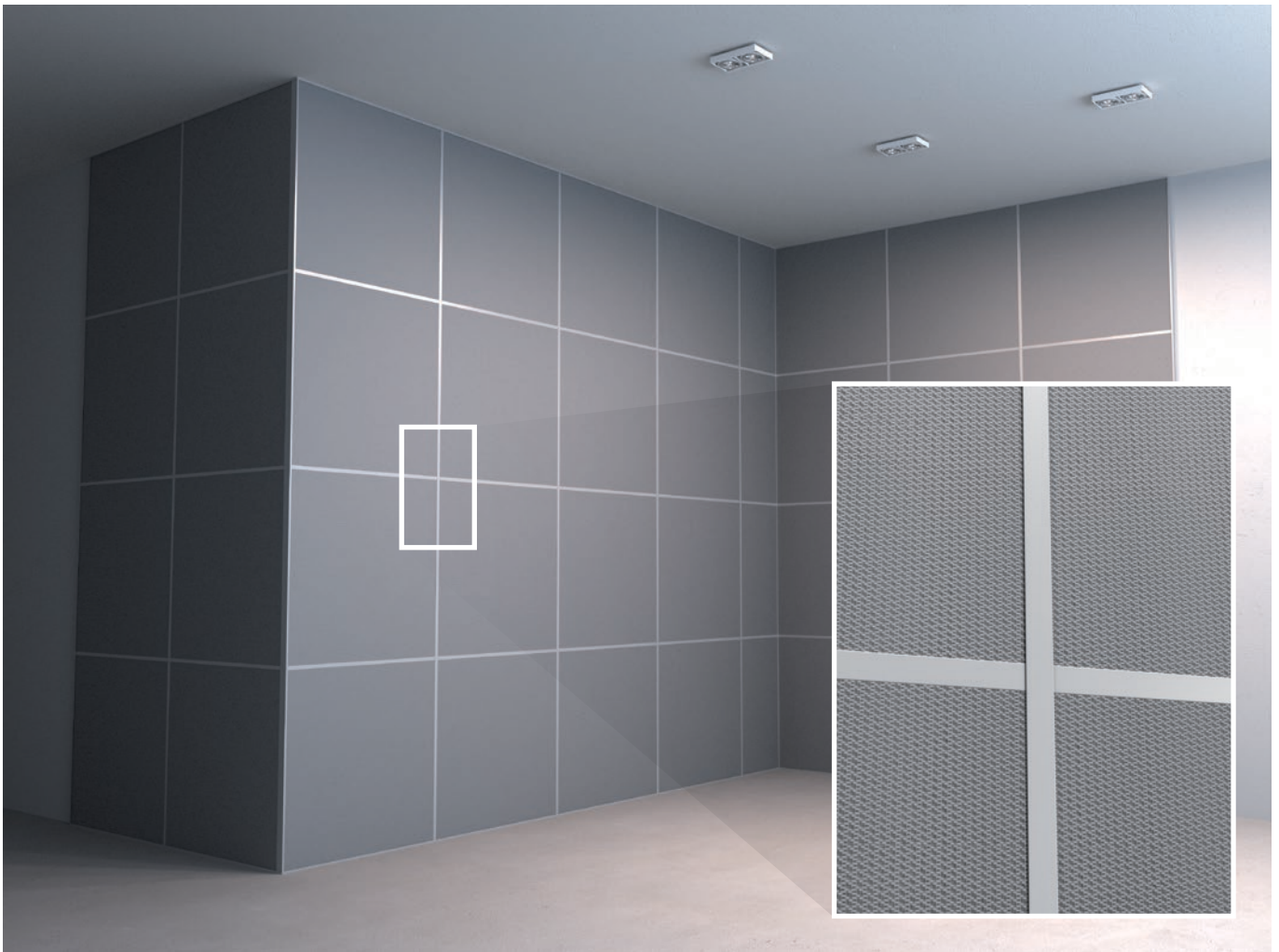

4.2 All Rockfon VertiQ A panels and tees installed.

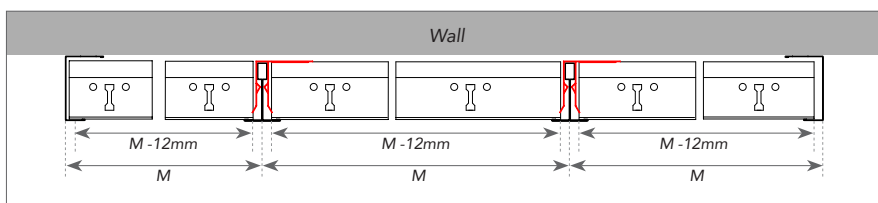

## General installation recommendations

### Panels

It is recommended to use clean nitrile or PU coated gloves when mounting Rockfon® panels in order to avoid finger prints and pollution of the surface.

For an optimised work environment, we recommend installers always observe common work practices and follow the installation advice as shown on our packaging.

Cutting is made easily with a sharp knife. All offcuts and holes must be treated according to local Building Regulations.

**Note!** Certain smooth matt surfaces are directional. To ensure consistency of the finished ceiling, it is important that all panels are mounted in one direction, as indicated by the arrow printed on the back of each panel.

## Tools

Rockfon has developed specific tools that are available on [en.rockfon.international](http://en.rockfon.international)



Visit our online CAD Library or BIM portal to assist you in your project design.



Generate specification texts for our products on our website.



Explore our vast library of reference projects on our website.

Rockfon® is a registered trademark  
of the ROCKWOOL Group.

 [linkedin.com/company/Rockfon-as](https://www.linkedin.com/company/Rockfon-as)

 [pinterest.com/Rockfon](https://www.pinterest.com/Rockfon)

 [youtube.com/RockfonOfficial](https://www.youtube.com/RockfonOfficial)

 [facebook.com/RockfonOfficial](https://www.facebook.com/RockfonOfficial)

 [instagram.com/Rockfon\\_Official](https://www.instagram.com/Rockfon_Official)

01:2022 | All colour codes mentioned are based on the NCS - Natural Colour System® property of and used on  
license from NCS Colour AB, Stockholm 2012 or the RAL colour standard. Subject to alterations in range and product  
technology without prior notice. Rockfon accepts no responsibility for printing errors.

## Sounds Beautiful

### Rockfon Singapore

ROCKWOOL Building Materials  
(Singapore) Pte Ltd.  
No. 7, Tuas Avenue 1  
Jurong Town,  
Singapore 639492  
Tel: (+65) 6861 4722  
Fax: (+65) 6862 3533  
E-mail: [enquiry@rockfon.com](mailto:enquiry@rockfon.com)  
[en.rockfon.international](http://en.rockfon.international)

### Rockfon Hong Kong

ROCKWOOL Building Materials  
(Hong Kong) Ltd.  
Unit 301-2, 3/F, Koon Wah Building,  
No.2 Yuen Shun Circuit,  
Yuen Chau Kok, Shatin,  
N.T., Hong Kong  
Tel: (+852) 2576-6117  
Mobile: (+852) 9161-7924  
E-mail: [enquiry@rockfon.com](mailto:enquiry@rockfon.com)  
[en.rockfon.international](http://en.rockfon.international)

### Rockfon

ROCKWOOL Middle East FZE  
Office 139, Building 6WB, DAFZA  
P. O. Box 293585, Dubai, UAE  
  
Tel: +971-4-214-6280  
E-mail: [rockfonme@rockfon.com](mailto:rockfonme@rockfon.com)  
[en.rockfon.international](http://en.rockfon.international)

### Rockfon

ROCKWOOL France S.A.S.  
111, rue du Château des Rentiers  
75013 Paris  
  
Tel: +33 1 40 77 82 82  
Fax.: +33 1 45 86 77 90  
E-mail: [info@rockfon.fr](mailto:info@rockfon.fr)  
[www.rockfon.fr](http://www.rockfon.fr)

