

Rockfon[®] System MediCare T24 A, E[™] (ECR)

System Description

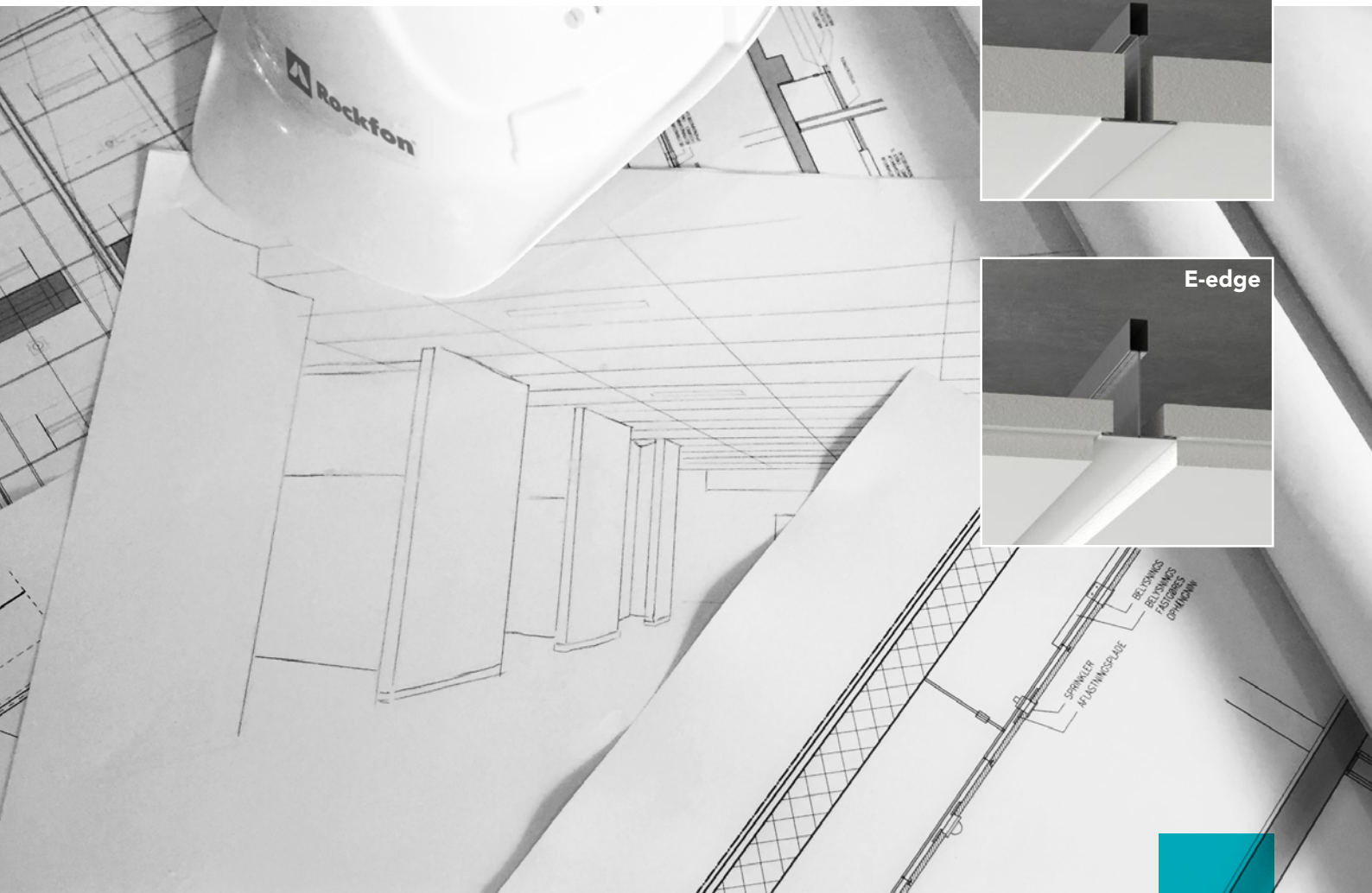

Concealed ceiling system
Unbroken look

- Elegant, unbroken ceiling expression
- Easy and fast to install
- Low installation height and full de-mountability
- Easy integration of services

Sounds Beautiful

Description

Rockfon System MediCare T24 A, E (ECR) range (incl. Standard, Plus and Air tiles) is specifically developed for healthcare. Hospitals and medical centers with unique and strict requirements in terms of hygiene, cleaning, disinfection and fire safety. The Rockfon MediCare tile range (Standard, Plus and Air) is specifically tailored to these needs.

The Rockfon MediCare range offers various performance levels (Standard, Plus and Air) tailored to the different needs for each risk zone (e.g. ER, Patient rooms, bathrooms, etc). All products in this range have a low particle emission, with a clean room classification of ISO class 3 for Rockfon MediCare Air and Plus and ISO class 5 for Rockfon MediCare Standard.

Thanks to their stone wool core, the Rockfon MediCare tiles have no nutritional value and do not form a breeding ground for harmful micro-organisms such as MRSA. The Rockfon MediCare tiles range has a fire reaction, class A1 for Rockfon MediCare Standard Plus and Air and offers optimal sound absorption.

Both grid systems have main runners and cross tees with a uniform height of 38 mm, ensuring stability and easier integration of services. The system provides a full demountability of all mounted tiles.

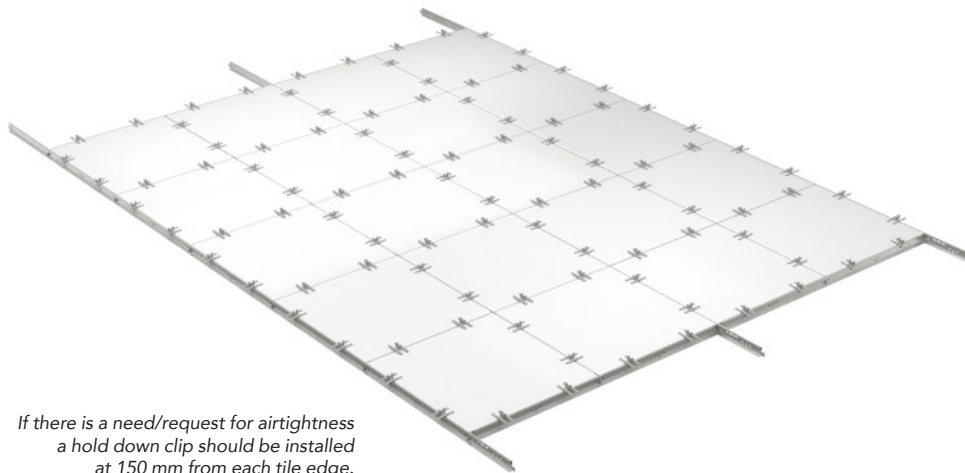

Click system providing easy and fast mounting and demounting.

The pictures of the installation methodology of the hold down clip is for illustration purposes.

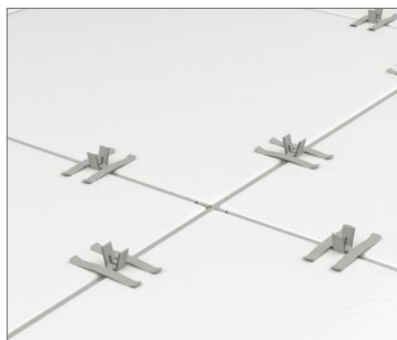

38 mm full height main runners and cross tees for stability and easy service integration.

Kindly contact your local Rockfon representative for the type of hold down clips most suitable for your region.

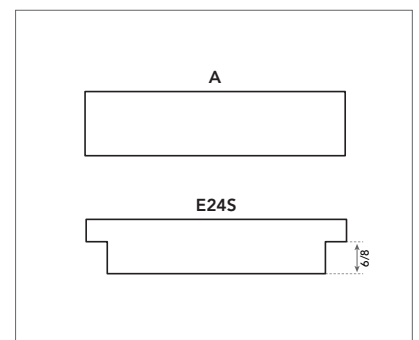

A and E edges ensuring fast mounting and full demountability.

Please note that hold down clips offered is different subject to the local rules and regulation.

Installation

Depending on the environmental and application needs 2 different system can be chosen:

1	Rockfon® MediCare® Standard/Plus.....	4
2	Rockfon® MediCare® Air.....	6

System components and consumption guide

1. Rockfon® MediCare® Standard/Plus

Tile	Chicago Metallic T24 3810			Wall angles		Accessories		
	1	2	3	4	5	6	7	
-	Main runner T24 Click 3600	Cross tee T24 Click 600	Cross tee T24 Click 1200	W Shadow moulding wall angle	Perimeter wall angle trim	Hanger	Hold down clip	
Dimensions (mm)	Consumption/m ²							
600 x 600	2,78 pcs/m ²	0,83 lm/m ²	0,83 lm/m ²	1,67 lm/m ²	1)	1)	0,70 pcs/m ²	1)
1200 x 600	1,39 pcs/m ²	0,83 lm/m ²	-	1,67 lm/m ²	1)	1)	0,70 pcs/m ²	1)

1) Consumption depends on room size.

Tiles - A, E edge



A edge



E edge

Chicago Metallic T24 3810

1. Main runner T24 Click 3600



2. Cross tee T24 Click 600



3. Cross tee T24 Click 1200



Wall angles

4. W Shadow moulding wall angle



5. Perimeter wall angle trim



Accessories

6. Hanger



7. Hold down clip



Performance

1. Rockfon® MediCare® Standard/Plus



System load bearing capacity

	Max. Load (kg/m ²)
Hanger distance (mm)	Max. 3,3 mm deflection
1200	21

The system's load capacity is determined from a max. deflection of the individual components corresponding to 1/500 of the span or the cumulative deflection of all structural components which does not exceed 3,3 or 4 mm. The load bearing capacity is given as regularly distributed load in kg/m², the weight of the tile is not included.

* Max. weight defined in function of max. allowable load of quick hangers.



Corrosion resistance

Chicago Metallic grids are manufactured from high quality hot dip galvanised steel with a coloured capping of pre-painted hot dip galvanised steel.

It resists corrosion and it can be used in standard humid environments.



Demountability

Tiles mounted in Rockfon System MediCare T24 A, E (ECR) are fully demountable.



Fire resistance

A range of Chicago Metallic steel grids are tested in accordance with BS 476: Part 23.



Hygiene

Stone wool provides no sustenance to microorganisms

Microbiological class M1 fulfilling the requirements of Zone 4 (very high risk) defined by NF S 90-351:2013.

Tested with:

- Methicillin Resistant Staphylococcus Aureus (MRSA)
- Candida Albicans
- Aspergillus Brasiliensis

The bactericidal and fungicidal effect of dry steam cleaning meets the requirements of

NF EN 14561 (>5 log10) and NF EN 14562 (> 4 log10), meaning the disinfection is very effective.



Clean Room

MediCare Standard: ISO Class 5

MediCare Plus: ISO Class 3



Surface durability

Enhanced durability and dirt resistance.



Cleaning

MediCare Standard:

- Vacuum
- Damp cloth

MediCare Plus:

- Vacuum
- Damp cloth
- Dry steam cleaning (twice a year)
- Chemical resistance: resistant to diluted solutions of ammonia, chlorine, quaternary ammonium and hydrogen peroxide.

System components and consumption guide

2. Rockfon® MediCare® Air

Tile	Chicago Metallic T24 3810			Wall angles	Accessories		
	1	2	3	4	5	6	7
-	Main runner T24 Click 3600	Cross tee T24 Click 600	Cross tee T24 Click 1200	Perimeter wall angle trim	Hanger	MediCare Hold down clip (for 25 mm tiles)*	Sealing tape
Dimensions (mm)	Consumption/m ²						
600 x 600	2,78 pcs/m ²	0,83 lm/m ²	0,83 lm/m ²	1,67 lm/m ²	1)	0,70 pcs/m ²	11,1 pcs/m ²
1200 x 600	2,56 pcs/m ²	0,8 lm/m ²	0,8 lm/m ²	1,6 lm/m ²	1)	0,70 pcs/m ²	8,3 pcs/m ²

1) Consumption depends on room size.

*Use the Medicare hold down clip in case airtightness is needed.

Tiles - A edge



A edge

Chicago Metallic T24 3810

1. Main runner T24 Click 3600



2. Cross tee T24 Click 600



Wall angles

4. Perimeter wall angle trim



3. Cross tee T24 Click 1200



Accessories

5a. Hanger



5b. Hanger



6. MediCare Hold down clip (for 25 mm tiles)



7. Sealing tape

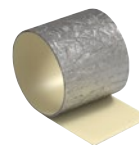

8. Component tape

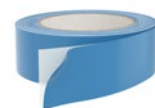

Performance

2. Rockfon® MediCare® Air



System load bearing capacity

	Max. Load (kg/m ²)
Hanger distance (mm)	Max. 3,3 mm deflection
1200	21

The system's load capacity is determined from a max. deflection of the individual components corresponding to 1/500 of the span or the cumulative deflection of all structural components which does not exceed 3,3 or 4 mm. The load bearing capacity is given as regularly distributed load in kg/m², the weight of the tile is not included.



Corrosion resistance

Chicago Metallic grids are manufactured from high quality hot dip galvanised steel with a coloured capping of pre-painted hot dip galvanised steel.

It resists corrosion and it can be used in standard humid environments.



Demountability

Tiles mounted in Rockfon System MediCare T24 A, E (ECR) are fully demountable.



Fire resistance

A range of Chicago Metallic steel grids are tested in accordance with BS 476: Part 23.



Hygiene

Microbiological class M1 fulfilling the requirements of Zone 4 (very high risk) defined by NF S 90-351:2013.

Tested with:

- Methicillin Resistant Staphylococcus Aureus (MRSA)
- Candida Albicans
- Aspergillus Brasiliensis

The bactericidal and fungicidal effect of dry steam cleaning meets the requirements of NF EN 14561 (>5 log₁₀) and NF EN 14562 (> 4 log₁₀), meaning the disinfection is very effective.

Performance

2. Rockfon® MediCare® Air



Clean Room

Rockfon MediCare Air: ISO Class 3



Air pressure

This solution is perfect for rooms where differential pressure is a needed requirement to stop infections from spreading outside the room. When used in combination with a HDC 2 (25 mm tile) or HDC 7 (40 mm tile), 11,2 clips/m² for 600 x 600 mm tiles, the high-performance membrane with sealed edges, and a closed neoprene foam tape (mandatory for 25 mm tile) you get an air leakage rate of less than 0.5m³/h/ m²/Pa under a pressure range of 5 to 40 Pa. The performance in areas where there are stringent air pressure requirements can always be improved by using a closed cell neoprene foam tape against the grid system. For more information, please contact customer service.



Surface durability

Rockfon MediCare Air has an Enhanced durability and dirt resistance surface.



Cleaning

The surface of MediCare Air has enhanced resistance and is highly water-repellent. It is treated to minimise dirt pick-up and finger marking – this being essential for ease of installation and frequent demounting for access to services. The surface can be vacuum cleaned with a soft brush attachment and it resists diluted solutions of the following: ammonia, chlorine, quaternary ammonium and hydrogen peroxide. Cleaning with a sponge or damp cloth may render the surface slightly shinier and we therefore recommend cleaning the whole surface evenly for best results. MediCare Air can also be cleaned and disinfected twice a year by steam cleaning following a protocol defined by experts and using an adapted surface mop.

Chemical resistance:

Tests were carried out in accordance with ISO 2812-1 (“Determination of resistance to liquids - Part 1: Immersion in liquids other than water”) and classification in accordance with VDI 2083 Part 17. Results are classified as ‘Excellent’ with the following detergents and disinfectants:

- Formalin (37%) – Ammoniac (25%)
- Hydrogen peroxide (30%) – Sulfuric acid (5%)
- Phosphoric acid (30%) – Peracetic acid (15%)
- Hydrochloric acid (5%) – Isopropanol (100%)
- Sodium hydroxide (5%) – Sodium hypochlorite (15%)

Grid Installation

1. Rockfon® MediCare® Standard/Plus

2. Rockfon® MediCare® Air

Grid layout and hanger location

Rockfon Medicare edge tiles can be installed in Rockfon System MediCare T24 A, E (ECR).
Some layout options are shown below depending on the size of the tile.

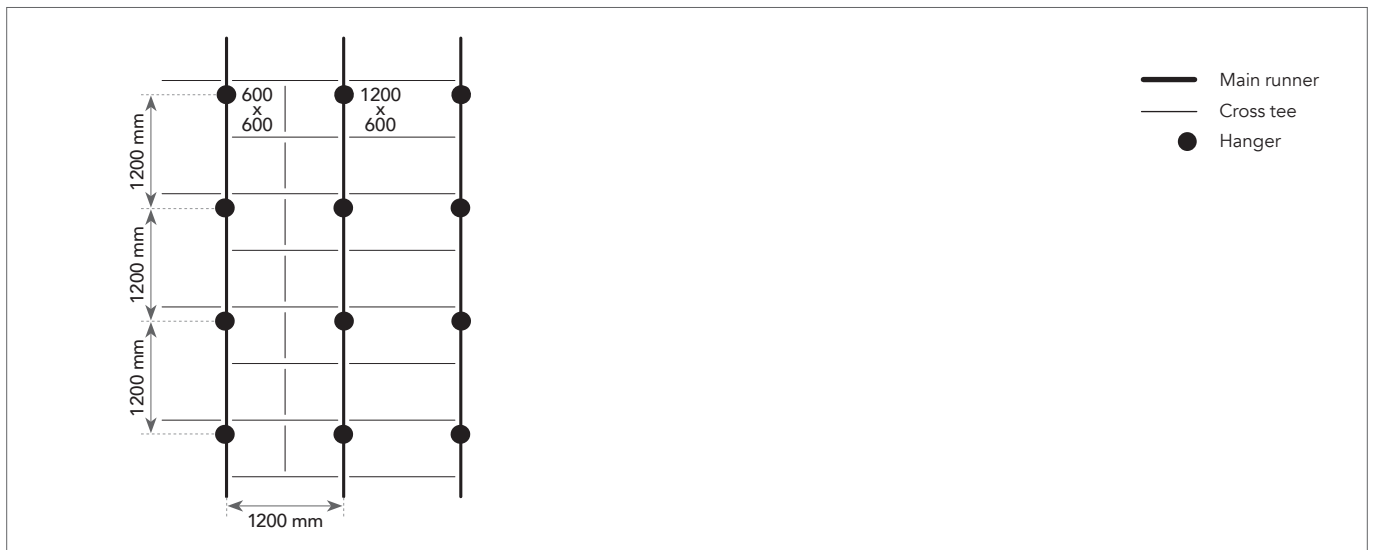

Installation requirements

During and after grid installation, it is important to check that T profiles are perfectly aligned horizontally. A maximum level difference of +/- 1 mm is recommended between profiles and should not be added. This tolerance is valid for all directions.

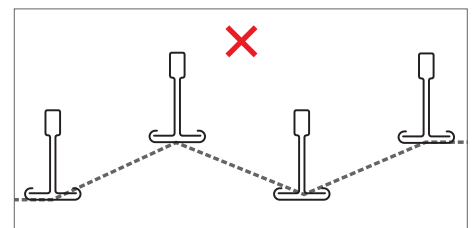
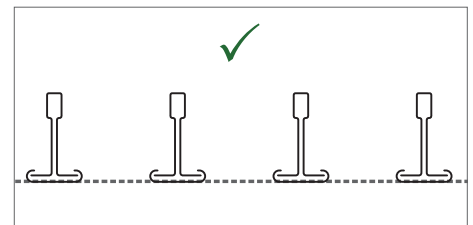

It is also important to check the squareness of the angles between the main runners and cross tees. This can be easily done by comparing the measurements of the two diagonals. See recommended tolerances on the table to the right.

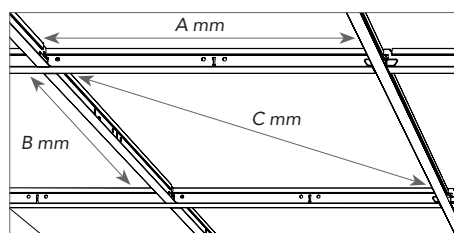

Dimensions (A x B)	Diagonal (C)	Tolerance
mm		
600 x 600	814,6	+/- 1,0
1200 x 600	1309,5	

Compatible Tiles Overview

1. Rockfon® MediCare® Standard/Plus

2. Rockfon® MediCare® Air

All Rockfon A and E edge tiles available in dimensions mentioned in the "System load bearing capacity" table on page 4 can be installed in Rockfon System MediCare T24 A, E (ECR).

Tiles	Edge	Thickness	Dimensions (mm)	
			600 x 600	1200 x 600
Rockfon® MediCare® Air	A24	25	•	•
Rockfon® MediCare® Plus	A24	20	•	•
	E24	20	•	•
Rockfon® MediCare® Standard	A24	15	•	•
	E24	15	•	•

Minimum installation depth (mm)

Tiles mounted in Rockfon System MediCare T24 A, E (ECR) give full demountability.

The installation depth is defined as the distance from the visible side of the tile to the underside of the substrate, where the hangers are fixed. D is the minimum installation depth for easy tile installation and demountability.

Tile thickness	Dimensions	D
	mm	
12-15-20-25	600 x 600 1200 x 600	100-150

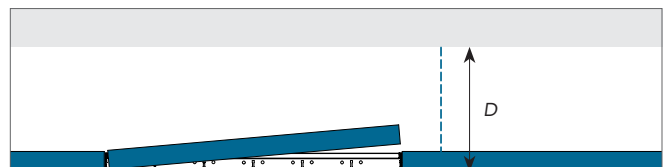

Perimeter Finish Options

Below are examples of perimeter finishing. Further details can be found on en.rockfon.international

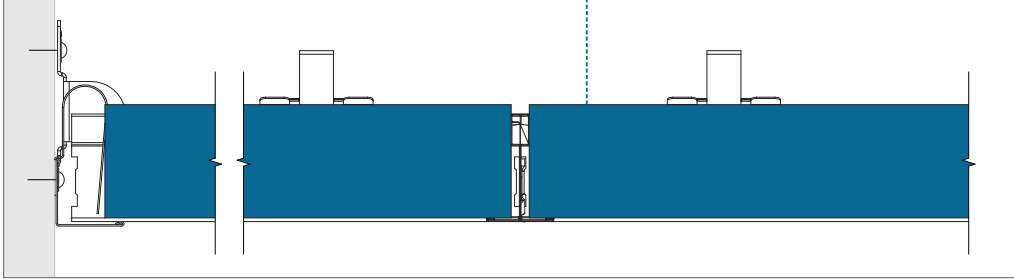

*A-edge - Perimeter finish with wall angle trim and wall spring fix.
Wall spring fix and the wall and bridging bracket are mandatory
when cleaning and/or pressure control are required.*

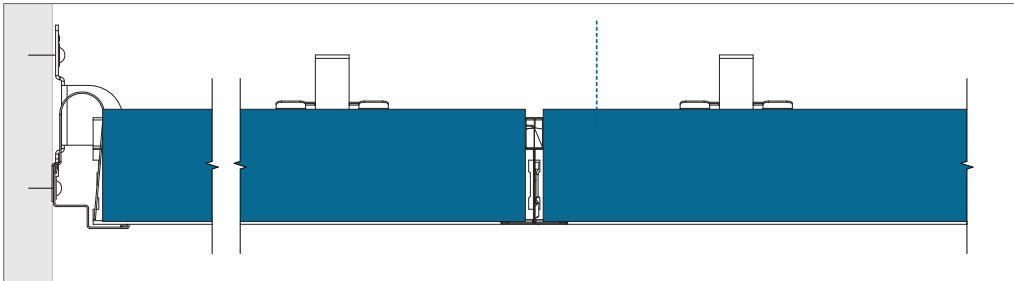

*E-edge - Perimeter finish with wall angle trim and wall spring fix.
Wall spring fix and the wall and bridging bracket are mandatory
when cleaning and/or pressure control are required.*

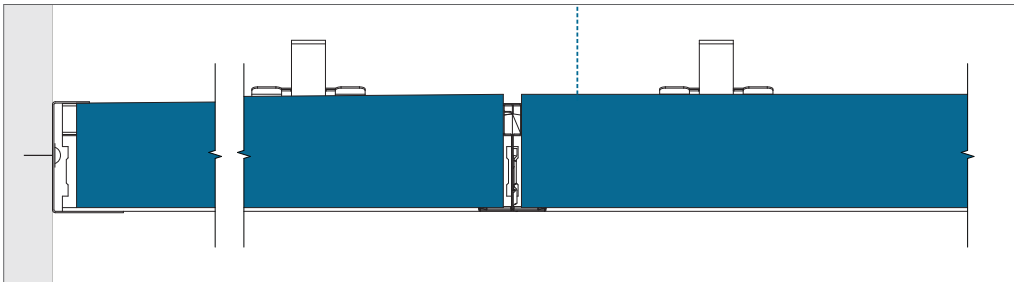

A-edge - Perimeter finish with J-wall angle.

Service integration

Rockfon ceiling tiles are easy to cut and therefore it is very easy to integrate services in Rockfon tiles. The cut-outs can be made with a simple utility knife.

When the ceiling system is installed to bear load, Rockfon recommends using support arms or a yoke that transfers the weight of the service to the grid. The size of the yoke should not be bigger than module 600 x 600 mm and the use of additional hangers to overcome deflection in the ceiling system is strongly recommended.

When using support arms to spread the weight of the installation, Rockfon recommends spanning a maximum of 600 mm and where necessary the use of additional hangers to counteract potential ceiling deflection. For more information on the load bearing capacities of this Rockfon System MediCare T24 A, E (ECR) please refer to the table below.

Note: Service integrations were not tested on air tightness.

Planning

A thorough planning and installation scheduling of the project/site will result in less re-work and less ceiling tile damage. Rockfon recommends discussing the installation planning thoroughly and well in advance with other installers that have to work in or near the suspended ceiling. By doing so damaged ceiling tiles and dirty spots on the finished ceiling surface can be avoided, which reduces project costs.

Overview load bearing capacity

	Weight of installations		
	< 0,25 kg/pcs	0,25 ≥ 3,0 kg/pcs	> 3,0 kg/pcs
Small service integration; Spot- or downlight, speaker, ventilation etc.	Drawing A	Drawing B	Suspend separately
Large service integration; Downlight, speaker, ventilation, etc.	Drawing A	Drawing B	Suspend separately
Modular lighting- or ventilation fixture	Drawing C; System load bearing capacity (if evenly distributed over grid in kg/m²)		

When installing services in Rockfon System MediCare T24 A, E (ECR) you should always follow local building regulations if more strict than the load bearing capacity constraints Rockfon recommends in the above table.

Contact your local Rockfon technical service for more information on suitable lighting fixtures, accessories and the different services integrated in Rockfon System MediCare T24 A, E (ECR). Special solutions with integrated services are, if available, shown on page 16 of this document; 'Tools'.

Drawing A

The integration of a spotlight, smoke detector, speaker, etc. (weighing < 0,25 kg/pcs).
Rockfon recommends installing spotlights and downlights centralized in the tile.

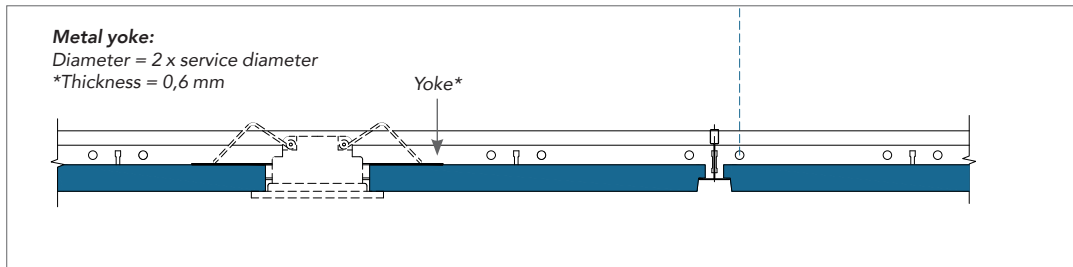

Drawing B

The integration of a downlight, spotlight, smoke detector, loud speaker, etc. (weighing 0,25 ≥ 3,0 kg/pcs).
Usage of an appropriate yoke to spread the load to the grid (as shown in the detail) or usage of support arms to spread the load to the grid system is strongly recommended. The use of additional hangers to avoid excess deflection and a centralized installation of the lighting in the tile is strongly recommended.

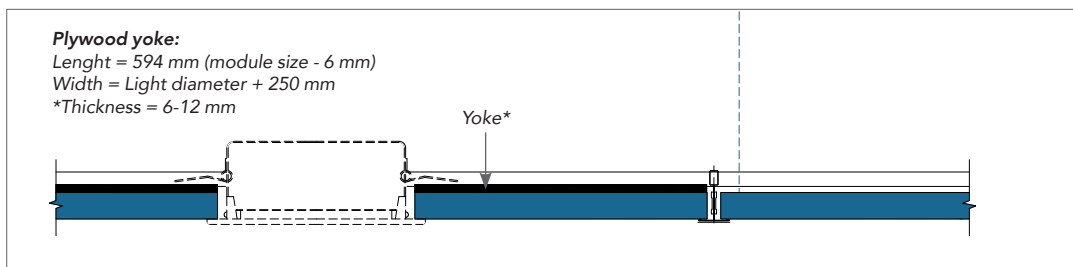

*The thickness of the plywood or metal yoke needs to be adapted in function of the weight, size and position of your service integration (e.g. downlight or speaker). The Plywood or metal yoke itself may not deflect after installing your service integration.

Drawing C

To reach the airtightness values of Rockfon MediCare Air ceiling installations all cut outs need to be closed with an airtight sealant.

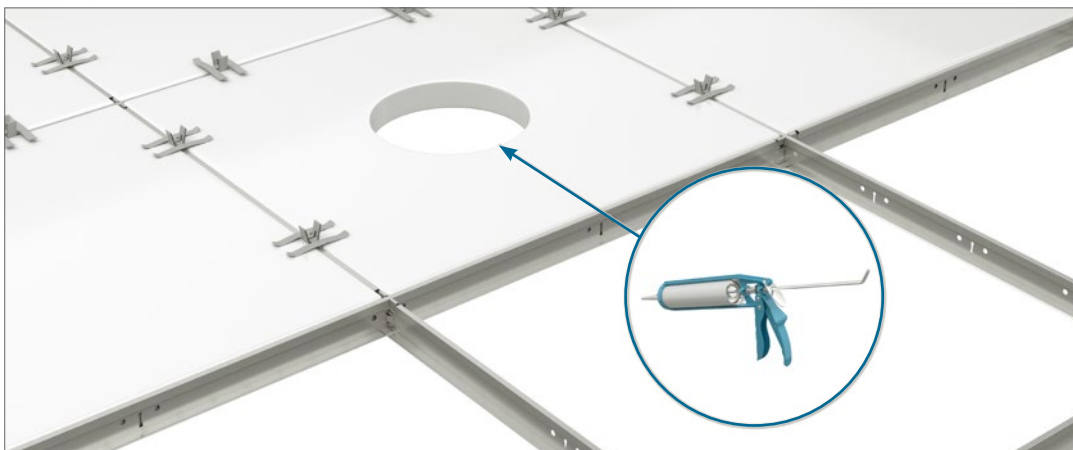

The pictures of the installation methodology of the hold down clip is for illustration purposes. Please note that hold down clips offered is different subject to the local rules and regulation. Kindly contact your local Rockfon representative for the type of hold down clips most suitable for your region.

Specific Solutions

MediCare Air Sealing tape

To seal custom-cut tiles, we provide an aluminum foil adhesive tape. It has good adhesion on the tile and eliminates fibre emission and dust which is essential in healthcare environments where particle emissions must be avoided. It is quick and easy to use. The sealing tape is air-tight as well as abrasion and humidity resistant. It is 75 mm wide and supplied in 50 m rolls.

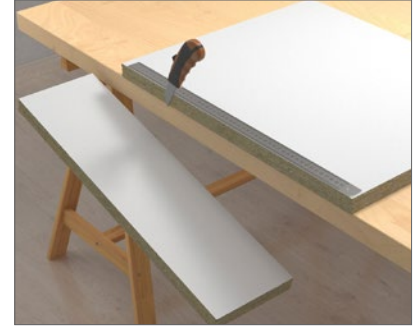
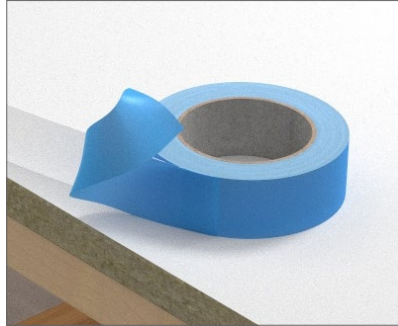

1. Cut on the needed dimension.

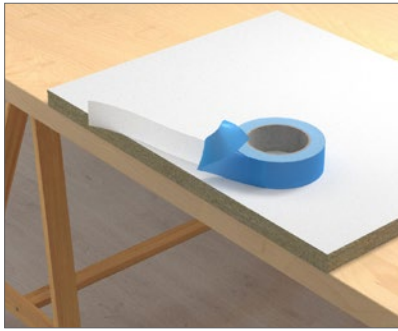

2. Measure edge + 10 mm and peel.



3. Align 5 mm overlap on front and press.



4. Flip tile to the back.



5. Peel.



6. Fold up and press.

Air sealed inspection hatch

Rockfon has developed an air sealed inspection hatch, in which the Rockfon ceiling tile (Air) is glued in the hatch for a uniform ceiling surface and better acoustics.

The hatch is made of galvanised steel powder coated white. It is fitted with 2 budget locks as a standard and is suitable for exposed grid, lay-in ceilings. It is available in 600 x 600 mm dimension. A polyester gasket seal ensures air-tightness between the hatch's frame and door. The frame of the hatch sits behind the T grid. Although it is fairly light (5,25 kg including tile), additional hangers on the grid may be necessary to improve stability. If damaged, the ceiling panel can easily be replaced with a new panel by demounting the locks.

Air-tightness of the air sealed inspection hatch in combination with Rockfon MediCare Air is documented. The use of neoprene foam tape on the grid in combination with 25 mm Rockfon MediCare Air tiles is recommended to improve airtightness performance of the entire ceiling / hatch system. A summary of the results is available upon request. For further information, please contact Rockfon.

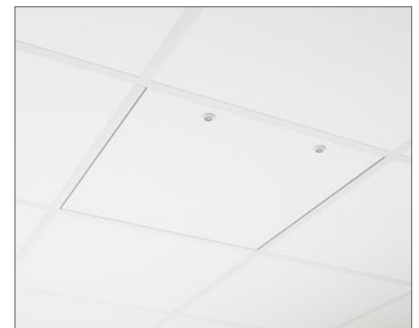

General installation recommendations

Junction between ceiling and wall or other vertical surface

The perimeter trim should be fastened to vertical surfaces at the required level using appropriate fixings at every 300-450 mm centres. Ensure that butt joints between adjoining lengths of trim are neat and that the trim is free from kinks and remains true and level. For the best aesthetics, use as long a length of trim as possible. The minimum recommended cut length is 300 mm.

Timber trims, timber shadow battens

Shadow mouldings should not be used with fire resisting/protecting ceilings.

Junction between ceiling and curved vertical surface

The use of a preformed curved perimeter trim is the most appropriate method. Rockfon can provide details of curved perimeter trims on request.

Corners

Perimeter trims should be neatly mitred at all corner joints. Overlap mitres are acceptable on metal trims on internal corner joints unless specified otherwise.

Suspension grid

Unless specified otherwise, the ceiling should be set out symmetrically and where possible, perimeter tiles should be greater than 200 mm in width. The hangers should be fastened with appropriate top fixings and to the main runners at 1200 mm centres (or less with greater load).

Main runners should be positioned at 1200 mm centres at all times. A/A distance of the cross tees depends on the module size of the tiles.

For proper grid installation, make sure the T profiles are perfectly aligned horizontally and diagonals of modules are equal (see requirements and tolerances on page 8). Main runner joints should be staggered and there should be a hanger positioned within 150 mm of the fire expansion element/cut-out and within 450 mm of the end of the main runner where it terminates at a perimeter.

Additional hangers may be necessary to support the weight of ceiling services. When using direct hangers, a fixing nail should be used to lock the hanger on to the bulb of the main runner.

Tiles

It is recommended to use clean nitrile or PU coated gloves when mounting Rockfon tiles in order to avoid finger prints and pollution of the surface.

For an optimised work environment, we recommend installers always observe common work practices and follow the installation advise as shown on our packaging.

Cutting is made easily with a sharp knife. All off-cuts and holes must be treated according to local Building Regulations.

Note! Certain smooth matt surfaces are directional. To ensure consistency of the finished ceiling, it is important that all tiles are mounted in one direction indicated by the arrow printed on the back of each tile.

Tools

Rockfon has developed specific tools that are available on en.rockfon.international



Visit our online CAD Library or BIM portal to assist you in your project design.

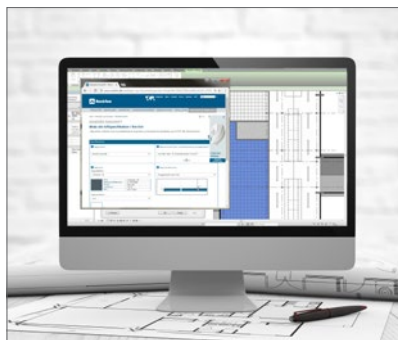

Generate specification texts for our products on our website.



Explore our vast library of reference projects on our website.

Rockfon® is a registered trademark
of the ROCKWOOL Group.

 [linkedin.com/company/Rockfon-as](https://www.linkedin.com/company/Rockfon-as)

 [pinterest.com/Rockfon](https://www.pinterest.com/Rockfon)

 [youtube.com/RockfonOfficial](https://www.youtube.com/RockfonOfficial)

 [facebook.com/RockfonOfficial](https://www.facebook.com/RockfonOfficial)

 [instagram.com/Rockfon_Official](https://www.instagram.com/Rockfon_Official)

05.2022 | All colour codes mentioned are based on the NCS - Natural Colour System® property of and used on
license from NCS Colour AB, Stockholm 2012 or the RAL colour standard. Subject to alterations in range and product
technology without prior notice. Rockfon accepts no responsibility for printing errors.

Sounds Beautiful

Rockfon Singapore

ROCKWOOL Building Materials
(Singapore) Pte Ltd.
No. 7, Tuas Avenue 1
Jurong Town,
Singapore 639492
Tel: (+65) 6861 4722
Fax: (+65) 6862 3533
E-mail: enquiry@rockfon.com
en.rockfon.international

Rockfon Hong Kong

ROCKWOOL Building Materials
(Hong Kong) Ltd.
Unit 301-2, 3/F, Koon Wah Building,
No.2 Yuen Shun Circuit,
Yuen Chau Kok, Shatin,
N.T., Hong Kong
Tel: (+852) 2576-6117
Mobile: (+852) 9161-7924
E-mail: enquiry@rockfon.com
en.rockfon.international

Rockfon

ROCKWOOL Middle East FZE
Office 139, Building 6WB, DAFZA
P. O. Box 293585, Dubai, UAE

Tel: +971-4-214-6280
E-mail: rockfonme@rockfon.com
en.rockfon.international

Rockfon

ROCKWOOL France S.A.S.
111, rue du Château des Rentiers
75013 Paris

Tel: +33 1 40 77 82 82
Fax.: +33 1 45 86 77 90
E-mail: info@rockfon.fr
www.rockfon.fr

