

Rockfon® System Industrial Baffle™

System Description



A framed baffle system

- Functional free-hanging acoustic solutions for noisy industrial environments
- Available in a natural, durable surface
- Ideal for areas where frequent or unhindered access to services is required
- Comes with a variety of quick and easy mounting options

Description

Rockfon System Industrial Baffle is an acoustic baffle system consisting of a 50 mm stone wool baffle. Its two edges are encased in a robust, galvanised steel frame, which provides multiple installation options. Both sides of the baffle are covered with an aesthetically pleasing, smooth mineral fleece.

Three installation options are available: **Rockfon Baffle Support Track Solution**, the **Rockfon Baffle T24 Solution** and the **Rockfon Baffle Quick Hanger Solution**.

This system is ideal for rooms and buildings where the use of a traditional suspended ceiling is technically not appropriate (e.g. where the principles of thermal mass is used in building design). It is a good and flexible solution to contribute to appropriate room acoustics in new buildings and to make room acoustic improvements in existing buildings. It is easy and fast to install.

Restrictions

Due to the risk of corrosion, the suspension accessories of Rockfon System Industrial Baffle should not be used in swimming pools or outdoor or in areas subjected to wind load and drafts.

Baffle – 2F-edge

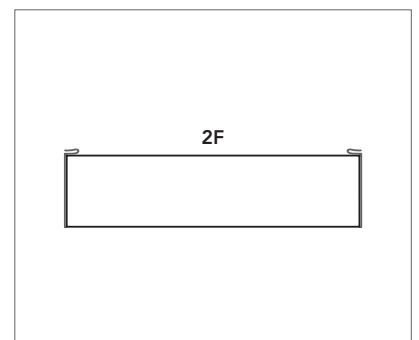

Rockfon Industrial Baffle 2F-edge.

Performance



Safety against failure

Class B (EN 13964:2014)



Corrosion resistance

Class B (EN 13964:2014)

Installation

There are 3 different kinds of installation,
providing design and installation flexibility:

1	Rockfon Baffle Support Track Solution	4
2	Rockfon Baffle T24 Solution	8
3	Rockfon Baffle Quick Hanger Solution.....	13

1. Rockfon Baffle Support Track Solution



Rockfon Industrial Baffles in parallel rows – in Support Tracks.

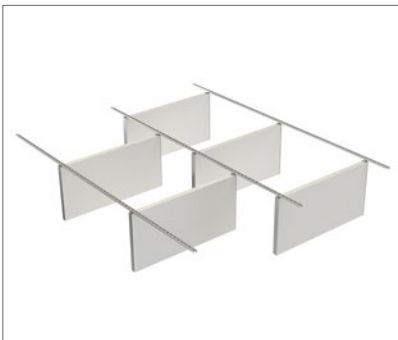

Rockfon Baffle Support Track Solution with a staggered installation.



Rockfon Industrial Baffle fixed in a Support Track.



Dimples on the end of the baffles to ensure good alignment.

1. Rockfon Baffle Support Track Solution

System components and consumption guide*

Baffles	Dimensions (mm)	Packing	Weight	Baffle row distance**		
				1200	600	300
Rockfon Industrial Baffle 2F	1200 x 600 x 50	6 pcs/box	20,2 kg/box	0,69 pcs/m ²	1,39 pcs/m ²	2,78 pcs/m ²
	1200 x 450 x 50	6 pcs/box	14,2 kg/box			
Accessories						
① Rockfon Baffle Support Track, 1,0 mm Galva	3000 x 30 x 30	8 pcs/box	25 kg/box	0,28 pcs/m ²	0,56 pcs/m ²	1,11 pcs/m ²
② Rockfon Baffle Support Track, 1,0 mm, White	3000 x 30 x 30	8 pcs/box	25 kg/box			
③ Rockfon Baffle Support Track, 1,0 mm, Black	3000 x 30 x 30	8 pcs/box	25 kg/box			
④ Rockfon Baffle Fixing Clip + M6 socket bolt		24 pcs/box	0,4 kg/box	2 pcs/baffle		
⑤ Rockfon Baffle Support Track Coupling***		48 pcs/box	1,5 kg/box	1 pc/Support Track		
⑥ Rockfon Baffle Support Track End Stop***		48 pcs/box	0,7 kg/box	2 pcs/row		

* For baffles in parallel rows, no gaps.

** Center distance between baffles' rows (mm).

*** Only if required.

Accessories

1. Rockfon Baffle Support Track, Galva



2. Rockfon Baffle Support Track, White



3. Rockfon Baffle Support Track, Black



4. Rockfon Baffle Fixing Clip + M6 socket bolt



5. Rockfon Baffle Support Track Coupling



6. Rockfon Baffle Support Track End Stop



1. Rockfon Baffle Support Track Solution

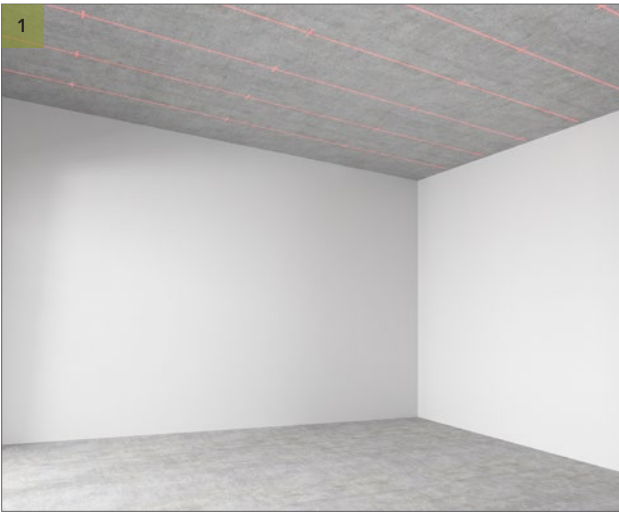

Use a laser to symmetrically mark drilling points in straight lines. Mark your drilling points on the soffit, at the ends of the Support Track and one in the middle.



Drill holes for the Support Track. Use fixings that are appropriate for the soffit.



Fix the Support Tracks to the soffit and level them properly. When necessary consider a use of flexible gaskets, e.g. rubber or foam gaskets, between Support Track and soffit – to compensate for uneven soffit surface and level Support Tracks. Remember to use fixings that are appropriate for the soffit. If required, use End Stop at the end of Support Track.

Note: if the Support Track is not level, the baffles are not level either!

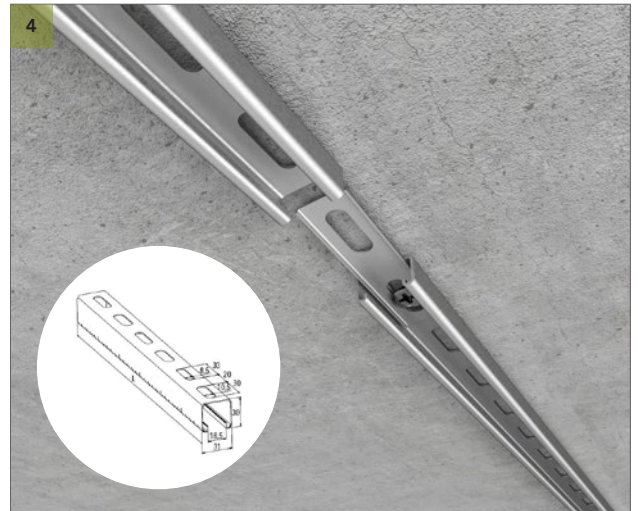

If required, use Rockfon Baffle Support Track Couplings when installing multiple lengths of Track. When using the Coupling, only one fixing point in the connector is needed instead of two.

1. Rockfon Baffle Support Track Solution



Connect a fixing clip to both ends of baffles using a hexagonal key and M6 socket bolt. Ensure that the clips are located parallel to the length of the baffle.

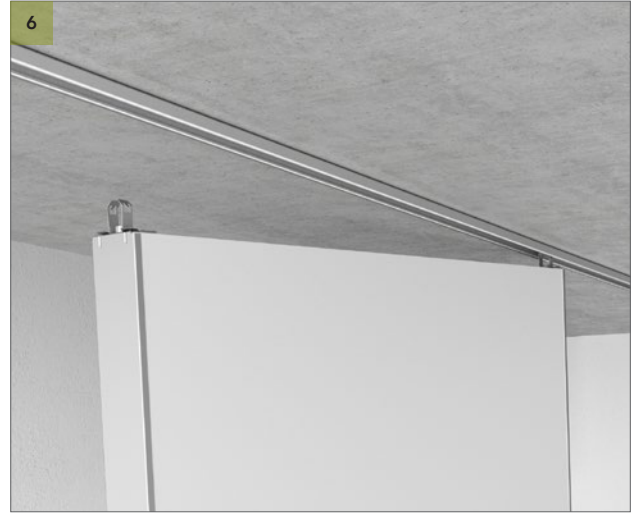

Attach the baffles to the Support Track. It is secure when you hear "click".



Fix baffles in the Support Track in the right position, as required. It is possible to 'fine tune' baffle position later.

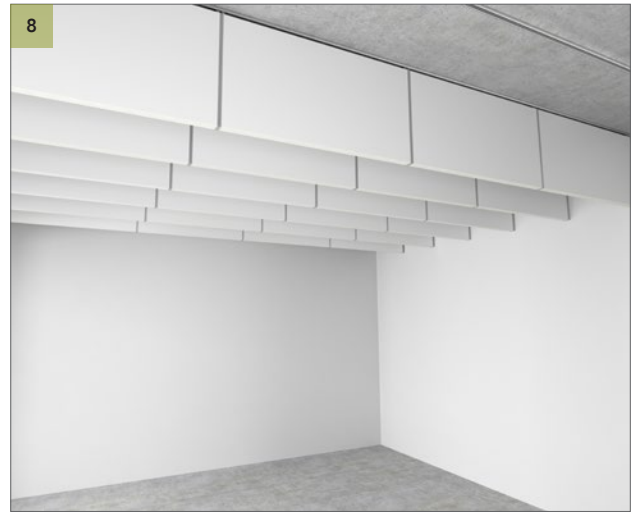

Install remaining Rockfon Universal Baffles and remember to use the dimples on the ends of the baffles to ensure alignment.

2. Rockfon Baffle T24 Solution

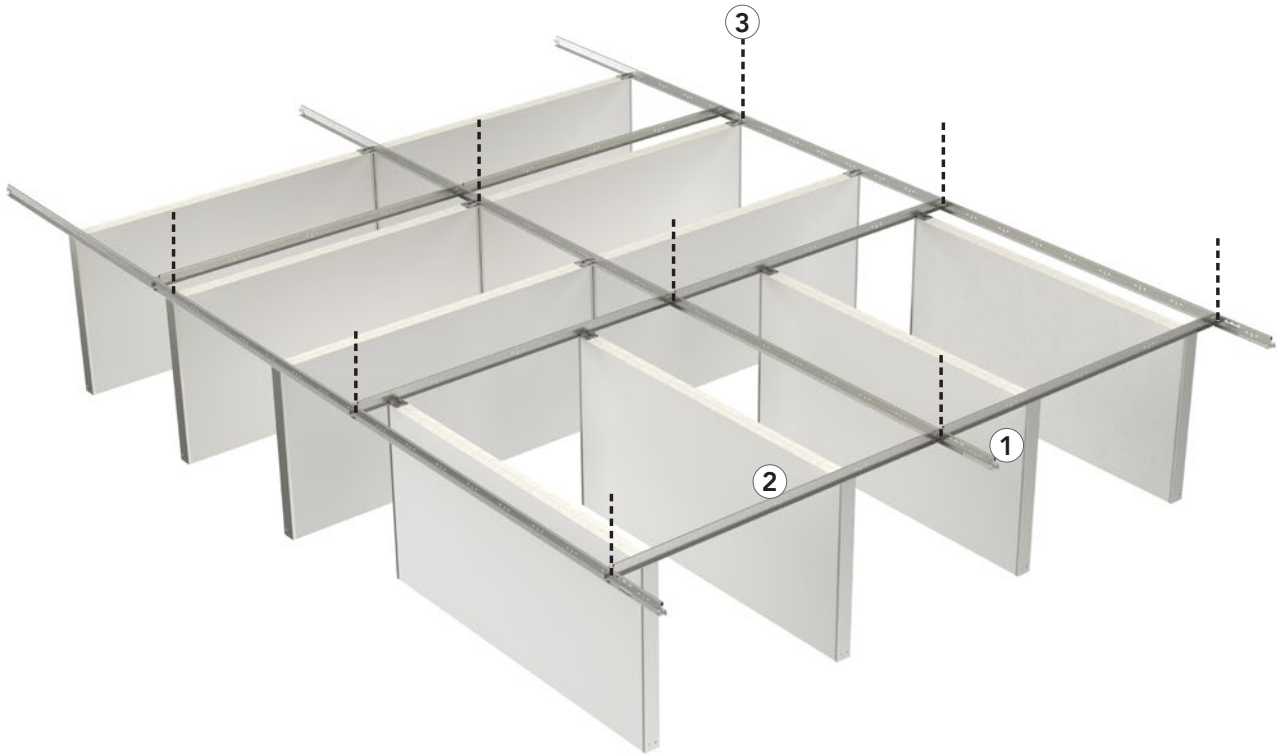

Rockfon Industrial Baffle fixed to a Chicago Metallic T24 profile.

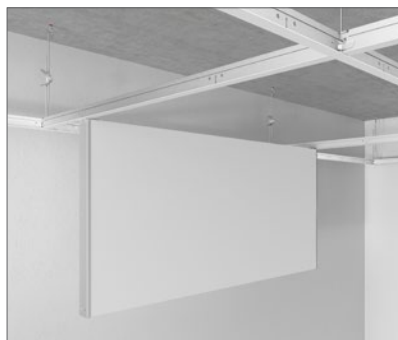

Rockfon Industrial Baffle fixed between Chicago Metallic T24 profiles.



Dimples on the end of the baffles to ensure good alignment.

2. Rockfon Baffle T24 Solution

System components and consumption guide*

Baffles	Dimensions (mm)	Packing	Weight	Baffle row distance**		
				1200	600	300
Rockfon Industrial Baffle 2F	1200 x 600 x 50	6 pcs/box	20,2 kg/box	0,69 pcs/m ²	1,39 pcs/m ²	2,78 pcs/m ²
	1200 x 450 x 50	6 pcs/box	14,2 kg/box			
Chicago Metallic T24 Click 3830						
① Main runner T24 Click 3600		20 pcs/box	21 kg/box	0,83 lm/m ²	0,83 lm/m ²	0,83 lm/m ²
② Cross tee T24 Click 1200		60 pcs/box	16,7 kg/box	0,83 lm/m ²	0,83 lm/m ²	0,83 lm/m ²
Accessories						
③ Quick-hangers HH 320		100 pcs/box	30 kg/box	0,69 pcs/m ²	0,69 pcs/m ²	0,69 pcs/m ²

* For baffles in parallel rows, no gaps.

** Center distance between baffles' rows (mm).

Chicago Metallic T24 Click 3830

1. Main runner T24 Click 3600



2. Cross tee T24 Click 1200



Accessories

3. Quick hanger



2. Rockfon Baffle T24 Solution

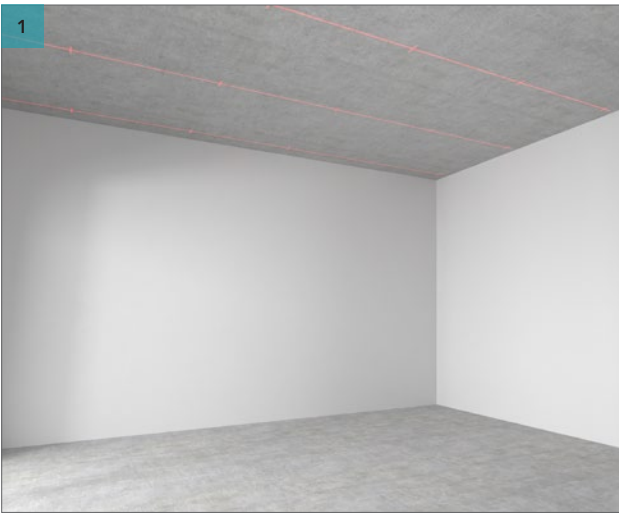

Use a laser to symmetrically mark drilling points in a straight line. Mark drilling points every 1200 mm on the soffit, in both length and width.



Drill where you have marked drilling points.

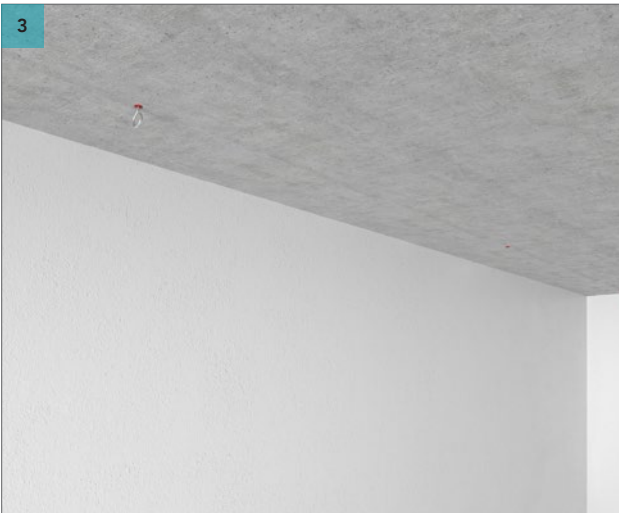

Use fixings that are appropriate for the soffit. Insert a screw eye into the soffit.



Attach quick-hangers (or rigid angle hangers) to the screw eyes and remember to secure them by closing the upper hook. Alternative suspension hangers can be used.

2. Rockfon Baffle T24 Solution

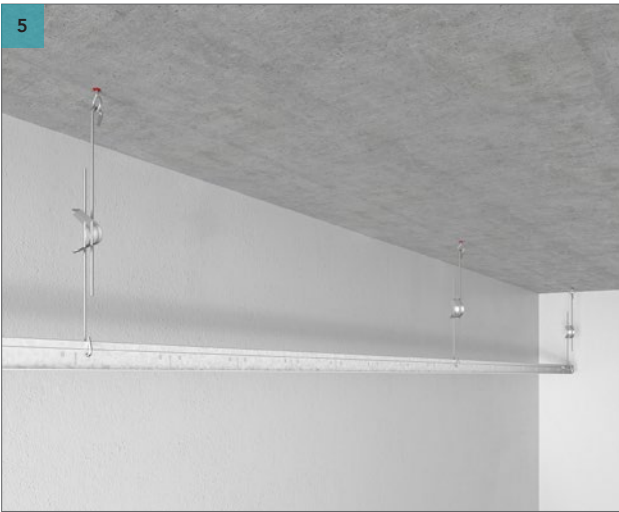

Attach main runner T24 3600 to the bottom of the quick-hangers and remember to secure them by closing the lower hook.



Install cross tee Click T24 1200 mm to main runners every 1200 mm.

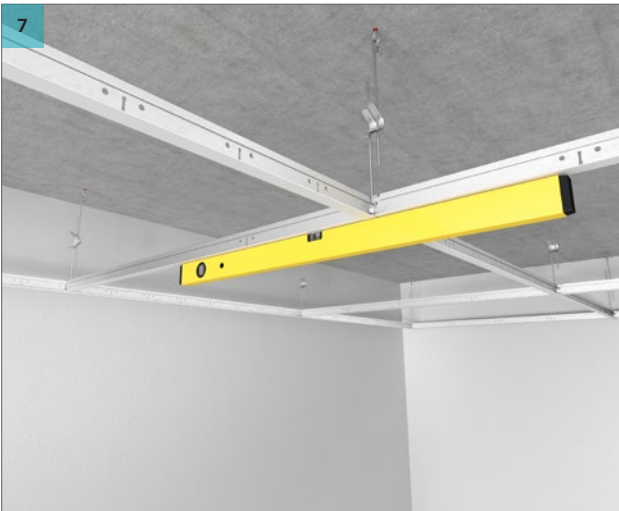

Adjust the level of the T24 profiles by using the quick-hangers' springs. Ensure the grid is leveled before installing baffles.
Note: if the T24 grid is not level, the baffles are not level either!



Fix the Rockfon Industrial Baffle to the suspended Chicago Metallic T24 grid.

2. Rockfon Baffle T24 Solution



Fix Rockfon Industrial Baffle to the suspended T24 profiles. You can use the slots of the T24 profiles to align the baffles.



Rockfon Industrial Baffles suspended between T24 profiles.



Fix the remaining Rockfon Industrial Baffles to the T24 grid and align them using the dimples on the end of the baffles.



Fix all the remaining Rockfon Industrial Baffles in the room.

3. Rockfon Baffle Quick Hanger Solution



Baffles in rows – common suspension for two baffles in a row.



Rockfon Industrial Baffles – suspension eyelet opened to vertical position.



Dimples on the end of the baffles to ensure good alignment.

3. Rockfon Baffle Quick Hanger Solution

System components and consumption guide*

Baffles	Dimensions (mm)	Packing	Weight	Baffle row distance**		
				1200	600	300
Rockfon Industrial Baffle 2F	1200 x 600 x 50	6 pcs/box	20,2 kg/box	0,69 pcs/m ²	1,39 pcs/m ²	2,78 pcs/m ²
	1200 x 450 x 50	6 pcs/box	15,3 kg/box			
Accessories						
① Quick-hangers HH 320		100 pcs/box	30 kg/box	1 pc/baffle + 1 pc/row		

* For baffles in parallel rows, no gaps.

** Center distance between baffles' rows (mm).

Accessories

1. Quick hanger



3. Rockfon Baffle Quick Hanger Solution

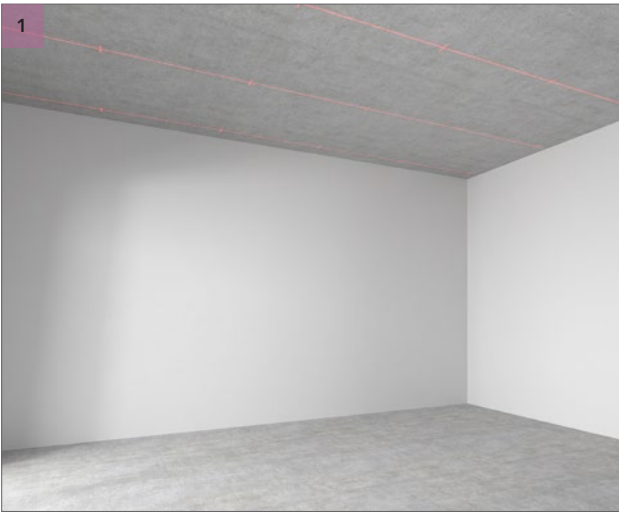

Use a laser to symmetrically mark drilling points in a straight line. Mark drilling points every 1200 mm on the soffit.



Drill where you have marked drilling points.

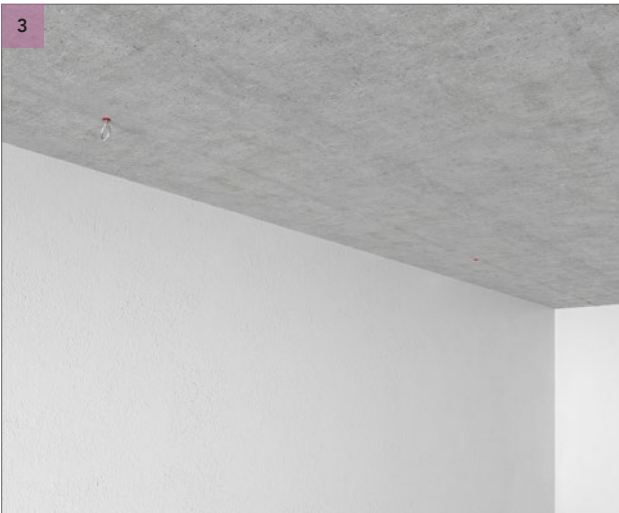

Insert plugs into the holes in soffit. Use fixings that are appropriate for the soffit.



Attach quick-hangers to the screw eyes and remember to secure them by closing the upper hook.

3. Rockfon Baffle Quick Hanger Solution

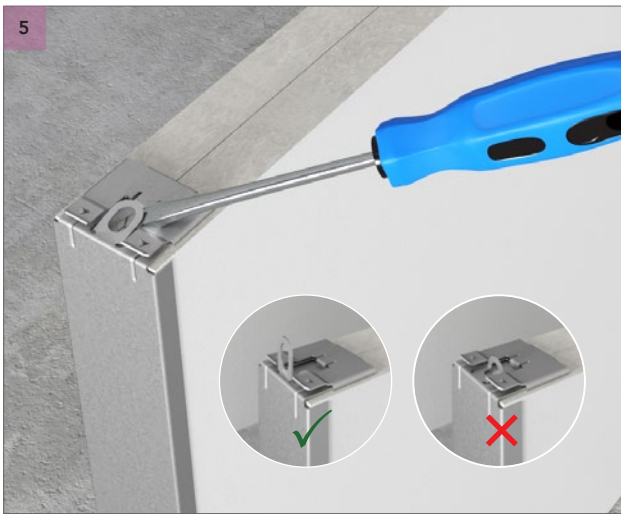

Lift up the flat eyelet on the top of the Rockfon Industrial Baffle.
Note: Ensure the eyelet is completely vertical.

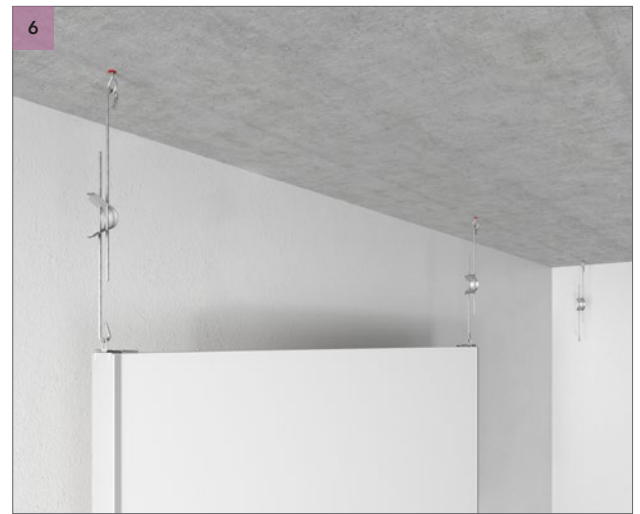

Suspend the Rockfon Industrial Baffles from the quick-hangers.



When necessary, twist the baffle to secure the eyelet onto your quick-hangers.



When suspending two Rockfon Industrial Baffles on the same quick-hanger, ensure that the alignment dimples match.

3. Rockfon Baffle Quick Hanger Solution



Place a level on top or underneath the Rockfon Industrial Baffle to ensure its evenness. Levelling can be done by compressing the quick-hanger spring to adjust the baffles height.

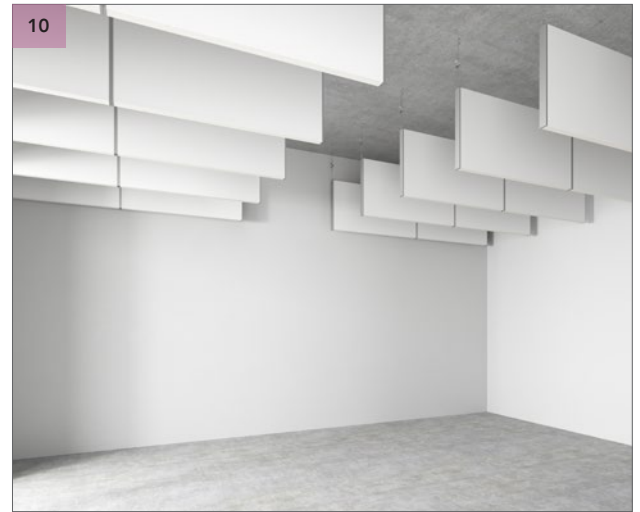

Align Rockfon Industrial Baffle using the dimples on the end of the baffle.

General installation recommendations

Safe and levelled soffit structure

Always ensure that the soffit structure is solid and that it has a minimum load bearing capacity of 10 kg per suspension point. Make sure that the soffit surface is even. If not, ensure that you level out the surface of the soffit if necessary before installing Rockfon Baffles solutions.

Suspension grid

Unless specified otherwise, the ceiling should be set out symmetrically and where possible the hangers should be fastened with appropriate top fixings to the main runners at 1200 mm centres (or less with greater load).

Main runners should be positioned at 1200 mm centres for 1200 mm long baffles.

For 1800 x 600 mm module sizes it's only possible to click the baffles on the main runners, when installing them perpendicular to the main runners. This means that for module 1800 x 600 mm the main runners should be positioned at 1800 mm centres.

For proper grid installation, ensure that the T profiles are perfectly aligned, horizontally and that the diagonals of the modules are equal. Main runner joints should be staggered and there should be a hanger positioned within 150 mm of the fire expansion element/ cut-out and within 450 mm of the end of the main runner where it terminates at a perimeter.

Additional hangers may be necessary to support the weight of ceiling services.

Baffles

It is recommended to use clean nitrile or PU coated gloves when installing Rockfon Baffles in order to avoid finger prints and pollution of the surface.

For an optimised work environment, we recommend installers always observe common work practices and follow the installation advise as shown on our packaging.

Tools

Rockfon has developed specific tools that are available on www.rockfon.asia.



Visit our online CAD Library or BIM portal to assist you in your project design.

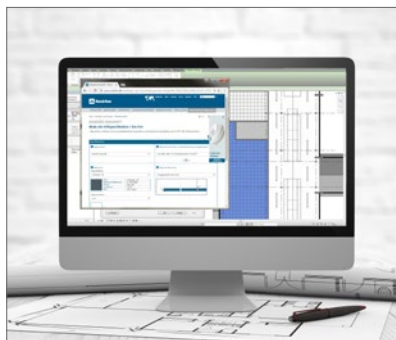

Generate specification texts for our products on our website.



Explore our vast library of reference projects on our website.

