

Rockfon® System Eclipse Wall™

System Description



Frameless wall system

- Enhanced design freedom using different shapes, angles and wall distances
- Perfect solution for room acoustic improvements
- A complete acoustic offering for open office solutions with standard Rockfon Eclipse® panels
- Easy and quick installation

Description

Rockfon System Eclipse Wall is a frameless acoustic solution available in a variety of geometric shapes. The visible side of the Rockfon Eclipse Wall panel features a minimalistic straight painted A-edge and is covered with a smooth, deep matt, super white painted fleece that has anti-static properties, extending product lifetime. The reverse side of the wall panel is covered with a white acoustic fleece.

Rockfon System Eclipse Wall should only be fixed using the specific Rockfon Eclipse Fixing Kits.

Two kits are available: a Direct Fixing Kit, creating a gap between the wall and the panel of 15 mm, and a Stepped Fixing Kit, creating a gap of 65 mm. By using a combination of both kits, overlapping wall panels is possible.

This acoustic system is ideal in rooms and buildings where the use of a traditional suspended ceiling is technically not appropriate (e.g. where the principle of thermal mass is incorporated in the building design) or is aesthetically unappealing. It is a good and flexible solution to make room acoustic improvements in existing buildings.

Restrictions

The Triangle can only be mounted with a peak facing downwards.

Due to the risk of corrosion, the fixing kits of Rockfon System Eclipse Wall should not be used in swimming pools or outdoor environments. Furthermore, Rockfon System Eclipse Wall should not be used in areas subjected to wind loads and drafts.

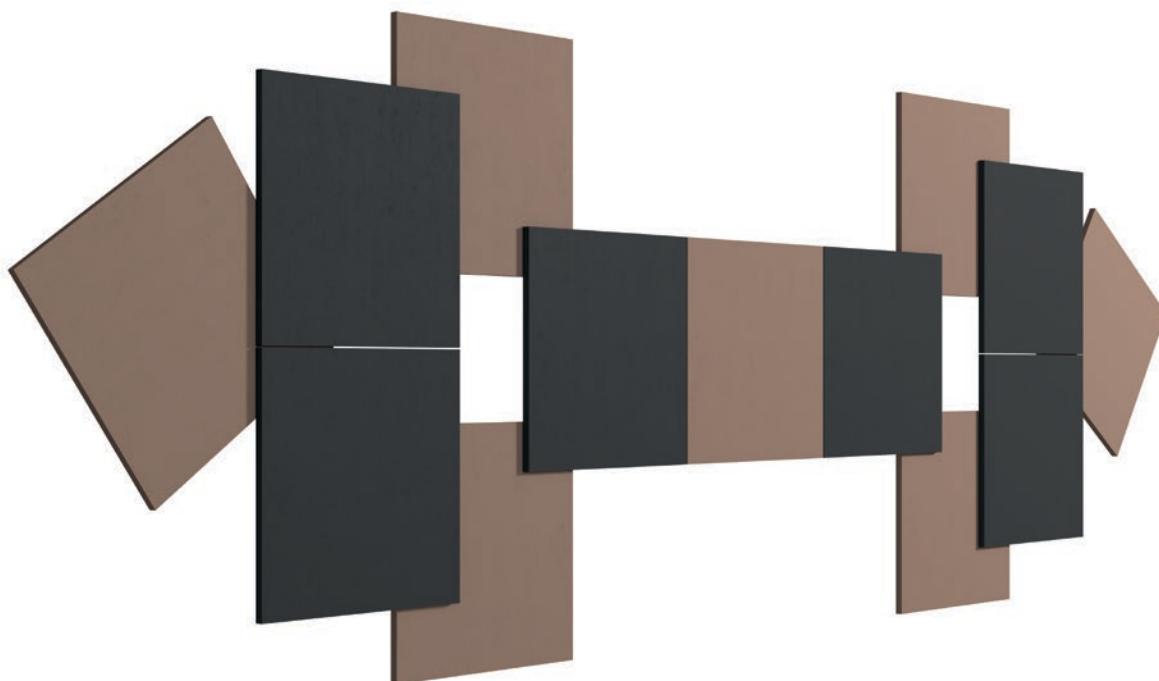

Rockfon distance holders are delivered together with a Rockfon Eclipse Wall Fixing Kits.





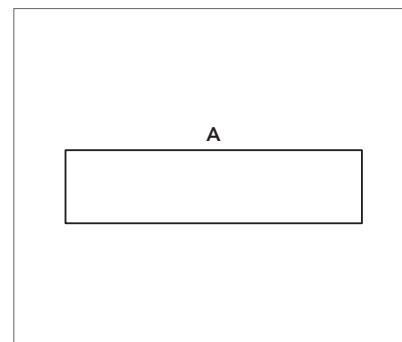

1. Direct fixing profile.
2. Stepped fixing profile.
3. Panel fixing profile.



Minimalistic painted straight A edge (Be edge for Rockfon Color-all®).

System components and installation guide

Rockfon Eclipse Wall panel is available in a variety of geometric shapes:

Rockfon Eclipse Wall panel		
Shapes	Dimensions (mm)	Approximate Weight (kg/unit)
Square 	1160 x 1160 x 40	9,0
Rectangle 	1760 x 1160 x 40	13,0
Circle 	800 x 800 x 40	3,0
Hexagon 	1160 x 1160 x 40	6,0

All rectangle and square Rockfon Eclipse Wall panels in custom colours are only available in a Be-edge. Size 2360 x 1160 x 40 mm is only available in custom colours on one side. Contact us for special shapes, colours, sizes, lead times and minimum quantities.

A Rockfon Eclipse Wall panel should be secured with a fixing kit comprising of a wall fixing profile, a panel fixing profile, a spacer nut M8 and a bolt M8.

We provide two suspension kits; the Direct solution and the Stepped solution.

Rockfon Eclipse Fixing Kits – Direct solution
Gap distance 15 mm
Wall fixing profile 15 mm
Panel fixing profile
Spacer nut M8
Spacer bolt M8 x 10 mm

Rockfon Eclipse Fixing Kits – Stepped solution
Gap distance 65 mm
Wall fixing profile 65 mm
Panel fixing profile
Spacer nut M8 + nut M8
Spacer bolt M8 x 60 mm

Panel - A Edge



Accessories

1. Wall fixing profile



2. Panel fixing profile



3. Distance holder
(spacer nut M8 + spacer bolt M8)



Performance



Corrosion resistance

Class B (EN13964)

Compatible Tiles Overview

Only Rockfon Eclipse Wall panels can be used in a Rockfon System Eclipse Wall.

Installation

Boxes should be handled with care and by two people. They should be stored in a flat, horizontal position. Each box contains a pair of gloves that should be worn when handling Rockfon Eclipse Wall panels.

For an optimised work environment, we recommend installers always observe common work practices and follow the installation advice, as shown on our packaging.

There are 6 different kinds of installation, depending on the shape of the Rockfon Eclipse Wall panel:

1	SQUARE / HEXAGON STRAIGHT	6
2	SQUARE / HEXAGON INCLINED.....	10
3	RECTANGULAR (1760 x 1160 mm)	14
4	CIRCLE (800 mm)	18

When installing any of the Rockfon System Eclipse Wall shapes, please use the marking tool below:

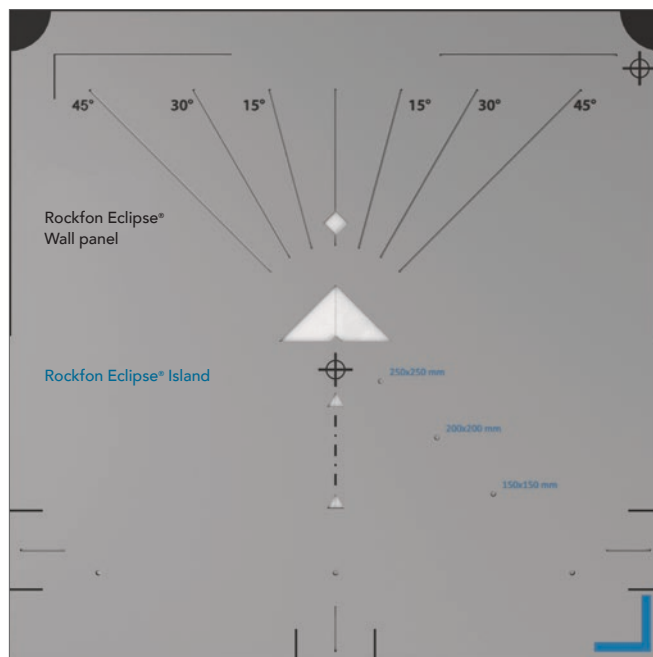

Marking tool.

Black prints are for the Rockfon Eclipse Wall panel.
Blue prints are for the Rockfon Eclipse Island.

1. SQUARE / HEXAGON STRAIGHT

This installation method can be used for both Square Straight and Hexagon Straight.



Mark a cross on the wall to indicate where you intend to fix the centre of your Rockfon Eclipse Wall panel. Make sure the upper leg of the cross is +/- 30 cm.

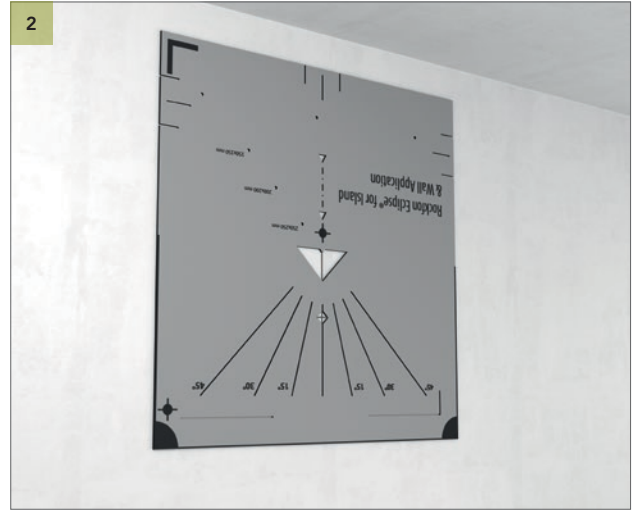

Place the marking tool above the cross drawn in step 1. Ensure that the centre of the cross aligns with the middle of the diamond cutout. See 2 - Detail.

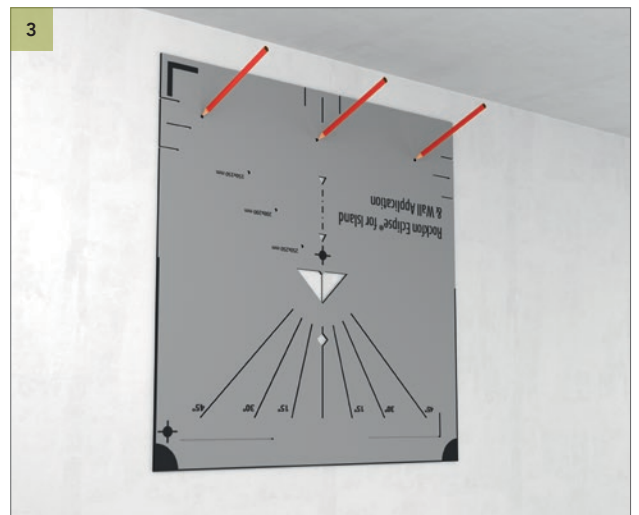
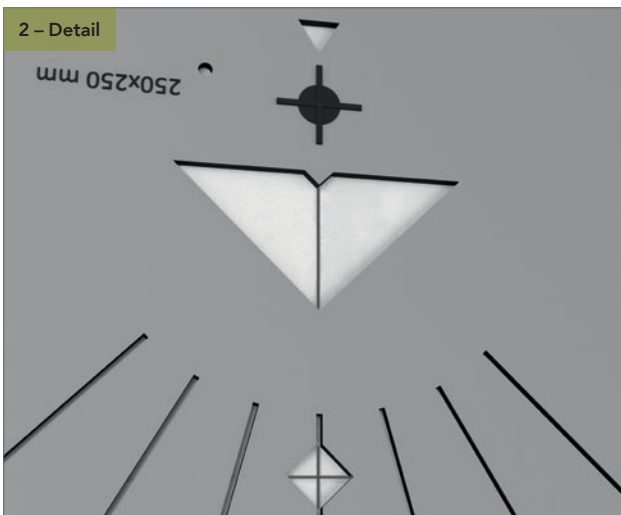

Mark the drilling holes.



Drill the holes and install the wall fixing profile.

1. SQUARE / HEXAGON STRAIGHT

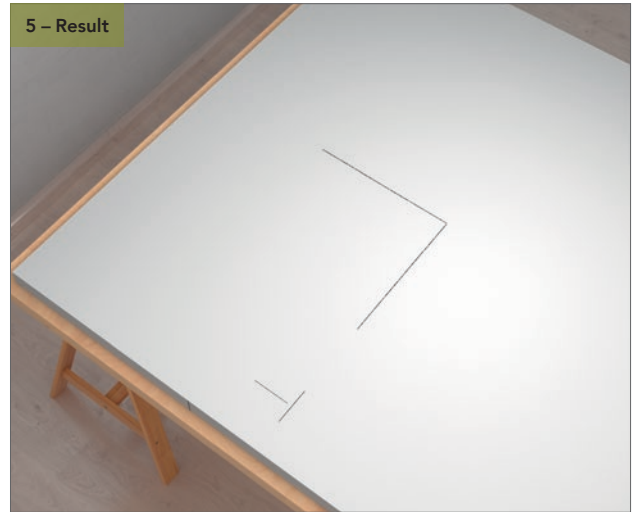
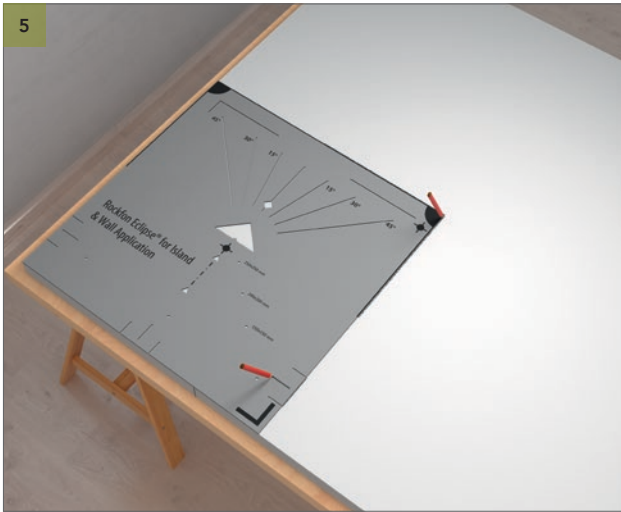

Position the marking tool in the lower left corner on the back side of the Rockfon Eclipse Wall panel. Mark with a pencil the centre lines, using the upper right corner of the marking tool, and the position of the distance holder. See 5 - Result.

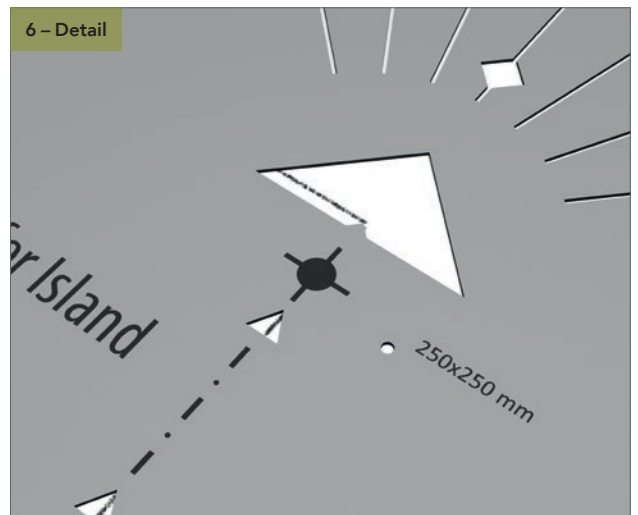
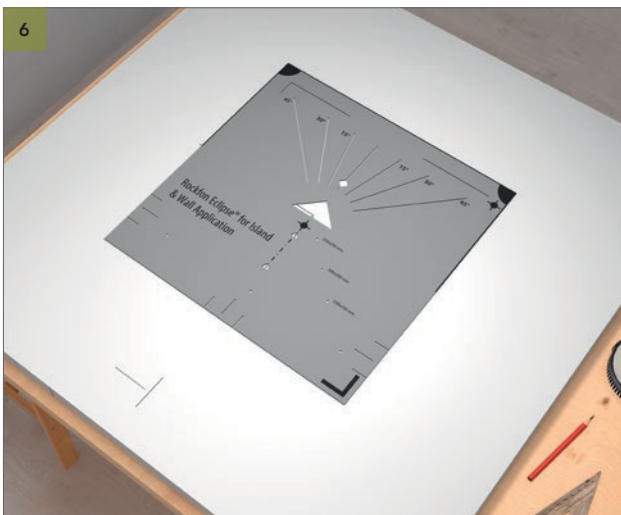

Position the marking tool so that the centre lines drawn in step 5 are perfectly aligned with the point at the base of the triangle on the marking tool. See 6 - Detail.

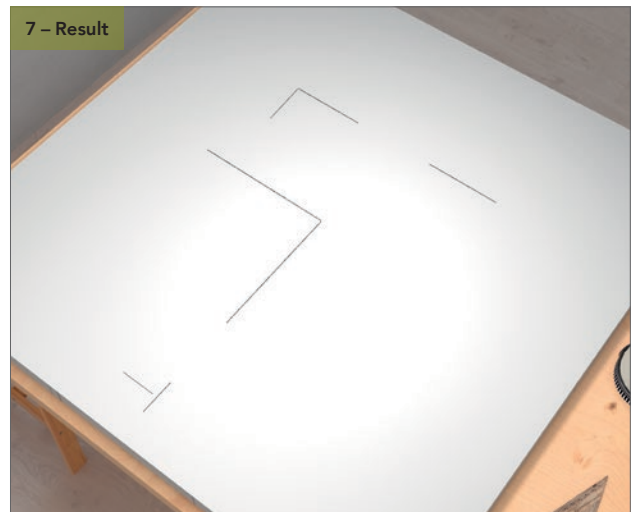
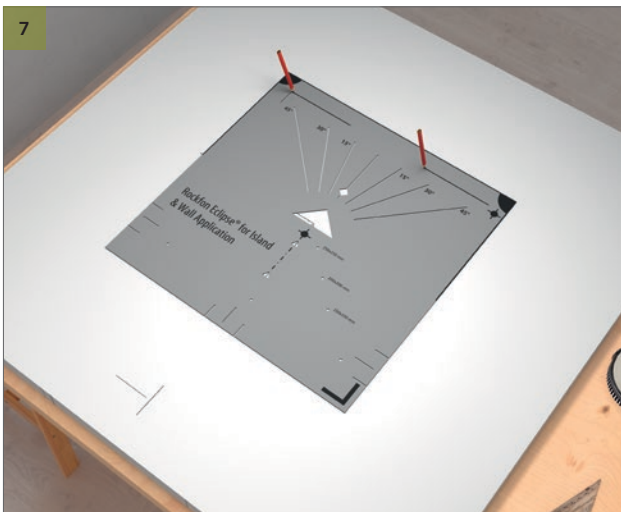

Mark the lines where the panel fixing profile must be inserted. See 7 - Result.

1. SQUARE / HEXAGON STRAIGHT

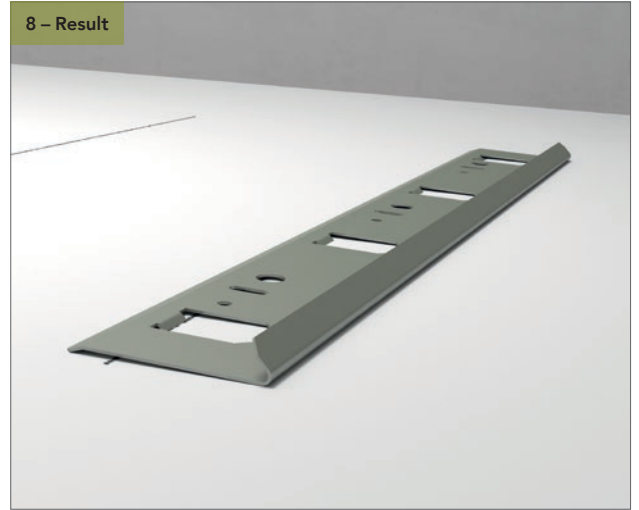
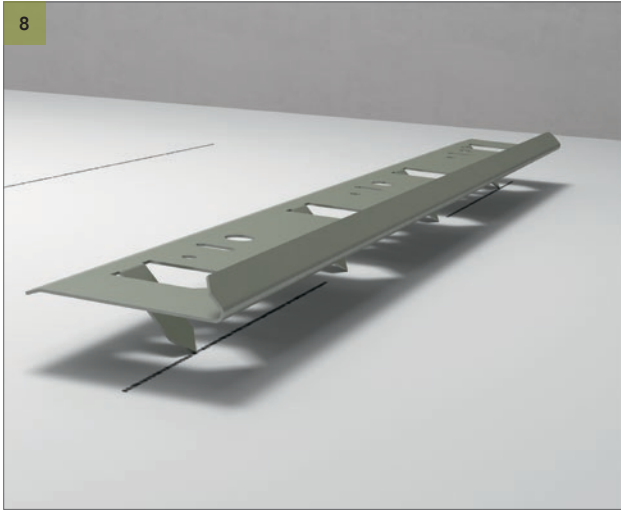

Insert the panel fixing profile into the wall panel. See 8 - Result.

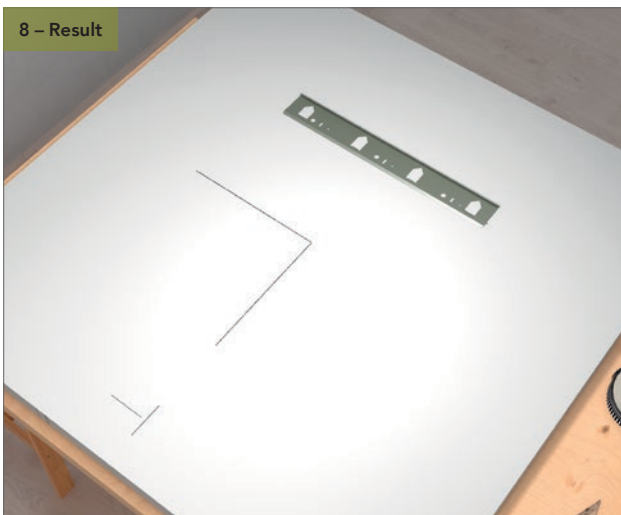

1. SQUARE / HEXAGON STRAIGHT

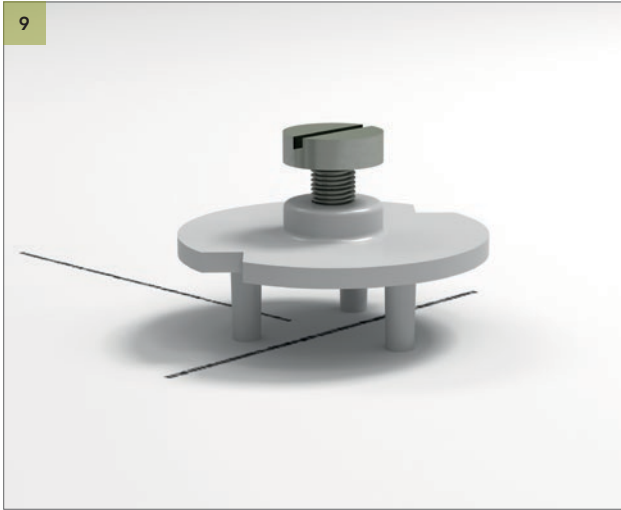

Insert the distance holder into the backside of the wall panel.
See 9 - Result.

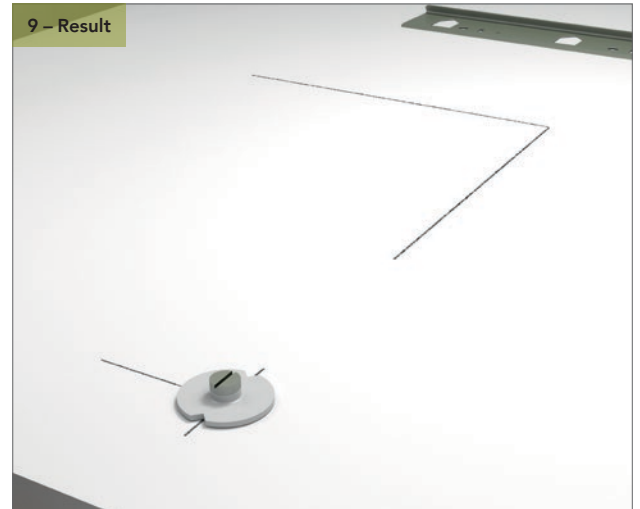

Place your Rockfon Eclipse Wall panel on the wall fixing profile and adjust the distance holder until the Rockfon Eclipse Wall panel is level.



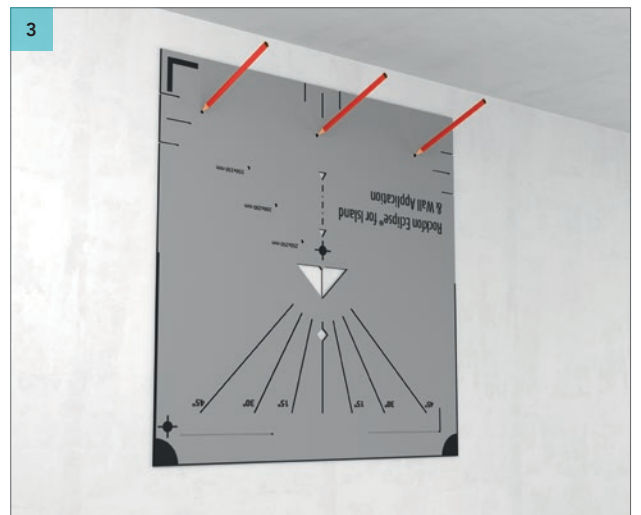
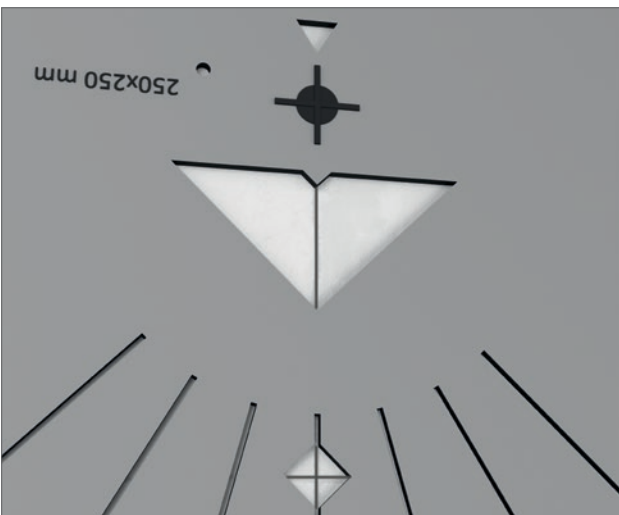
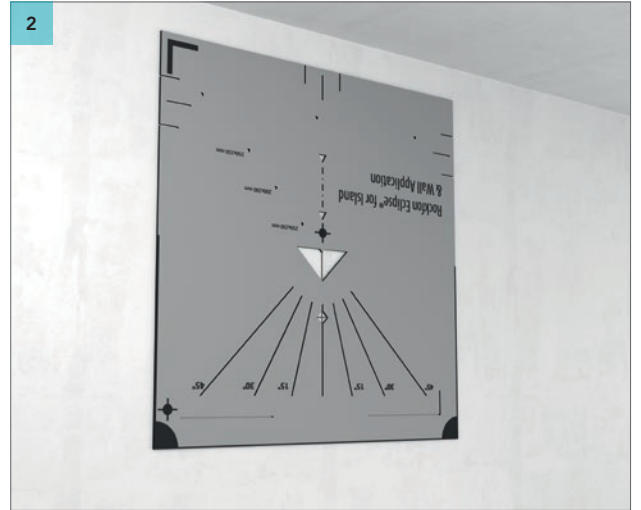

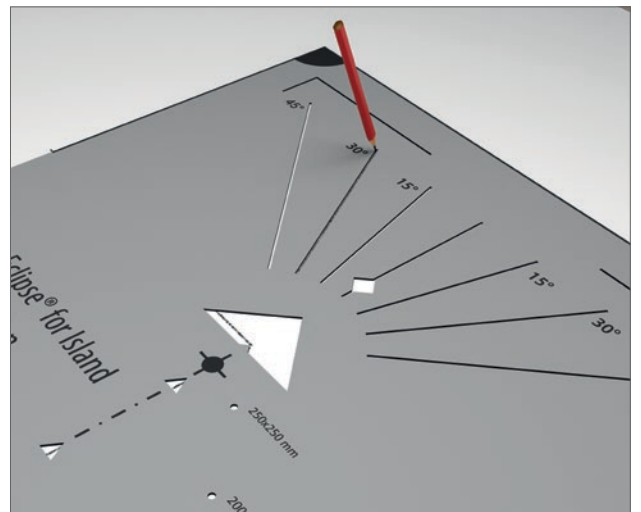
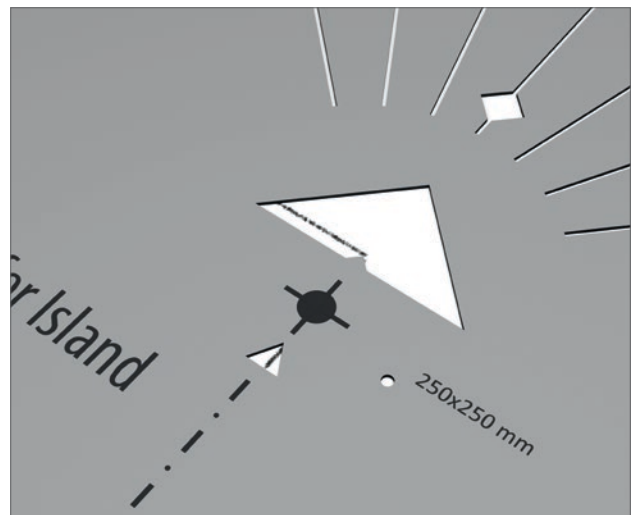
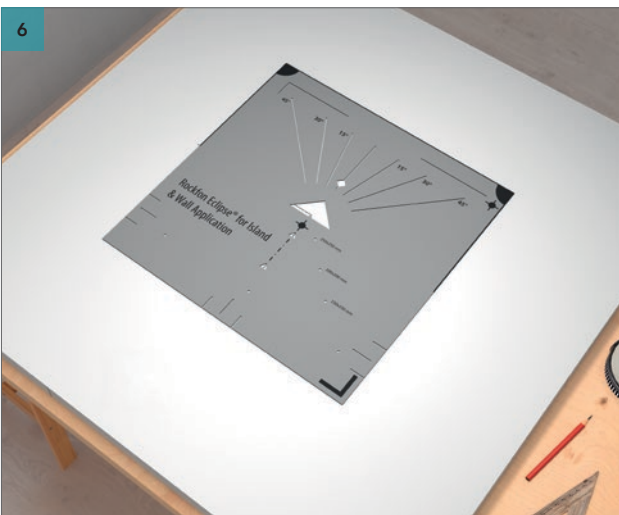
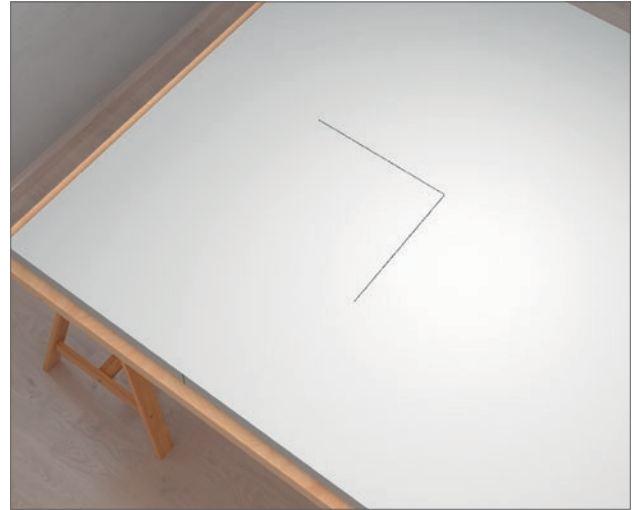
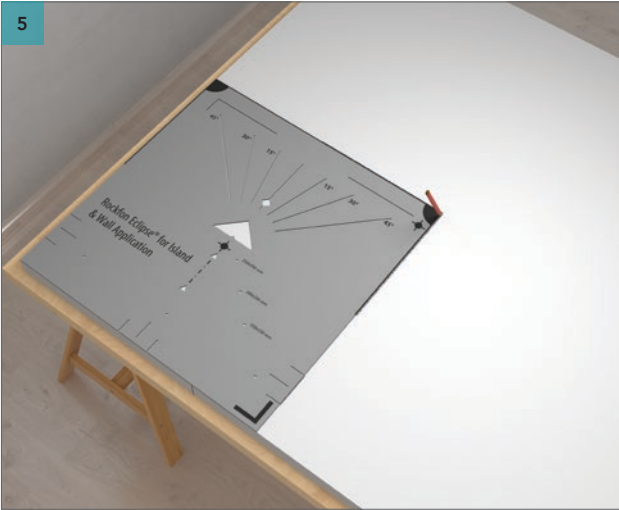

2. SQUARE / HEXAGON INCLINED

7 – Result

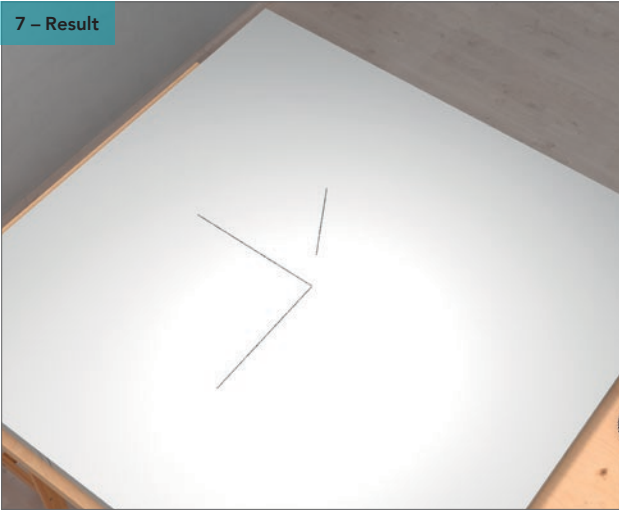

8

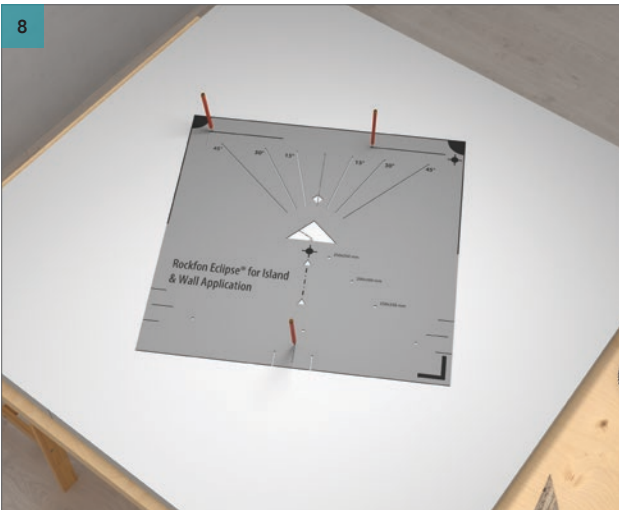

Position the marking tool so that the degree line from step 7, the angle you wish to hang the wall panel, is perfectly aligned with the point at the base of the triangle on the marking tool. Use the marking tool to indicate the position of the distance holder. See 8 - Detail.

8 – Detail

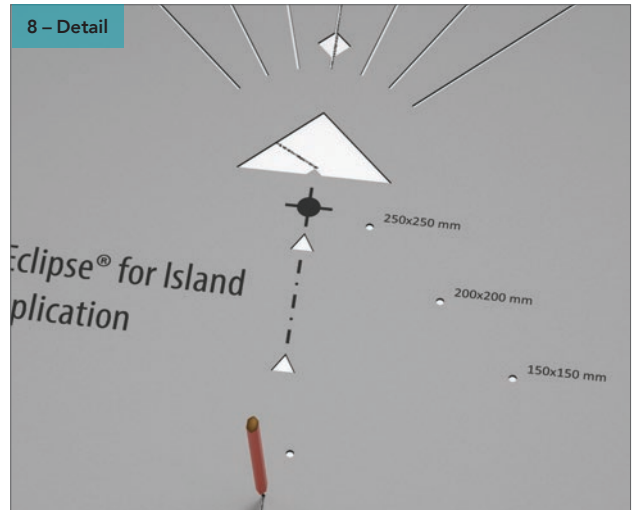

The point at the base of the triangle should be positioned at the midpoint of your marking. The line marking the angle should be in the 0° line of the marking tool.

8 – Result

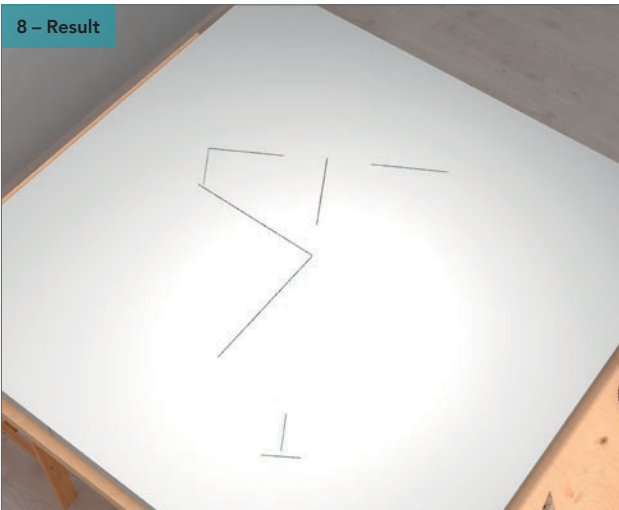

9

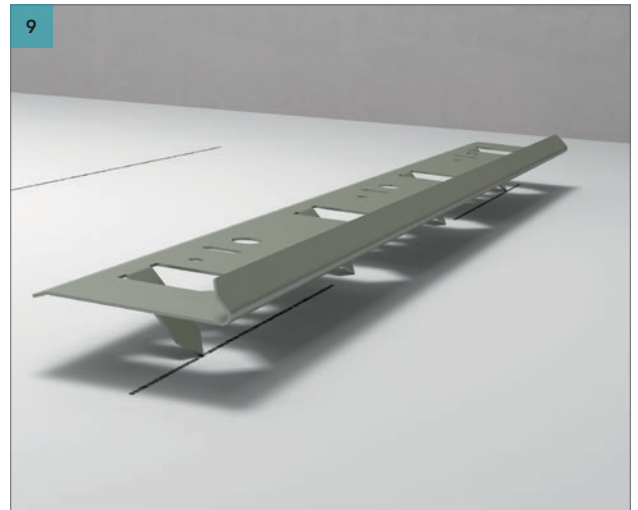

Insert the panel fixing kit into the wall panel. See 9 - Result.

2. SQUARE / HEXAGON INCLINED

9 – Result

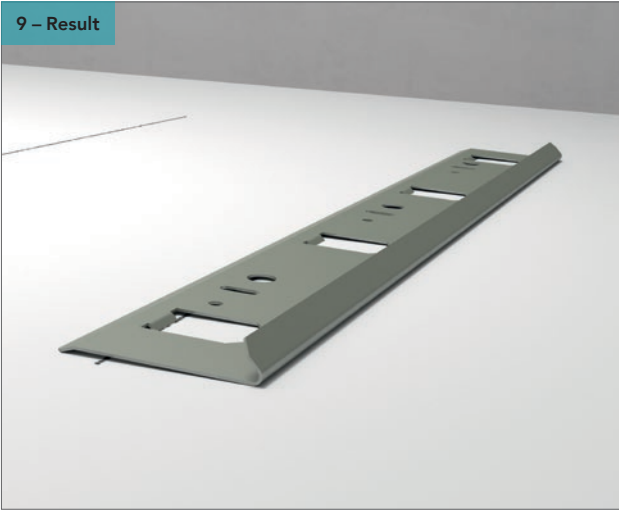

9 – Result

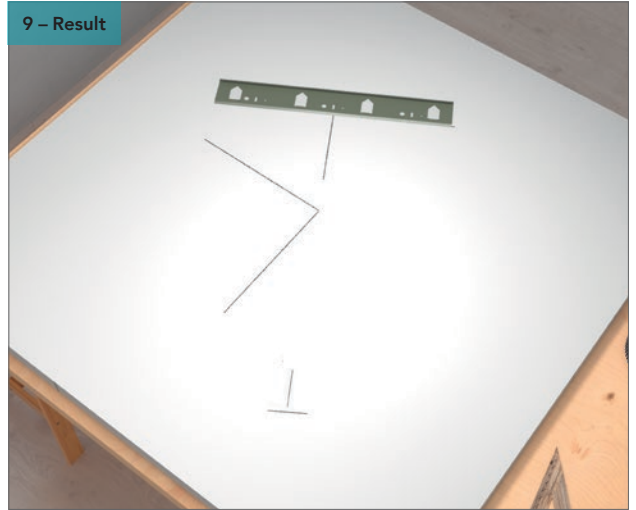

10

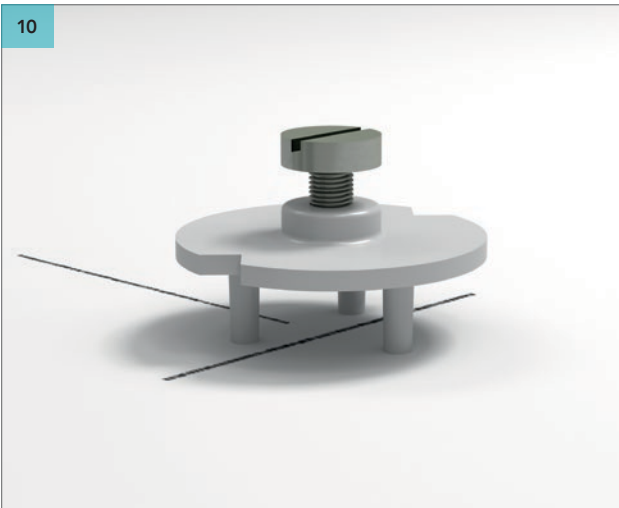

10 – Result

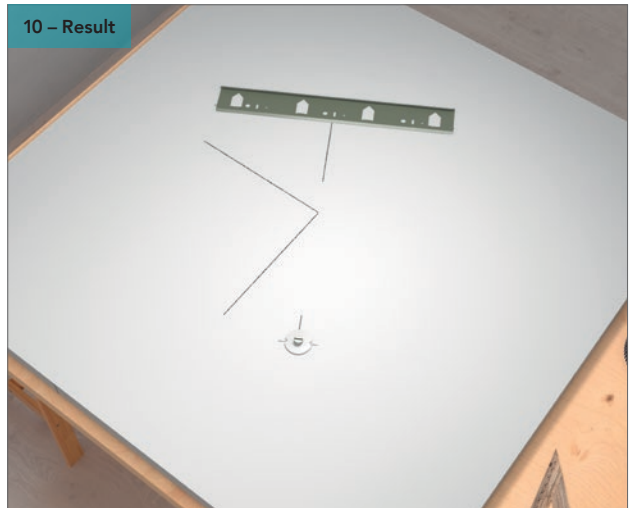

Insert the distance holder into the backside of the wall panel. See 10 - Result.

11



11 – Detail



Place your Rockfon Eclipse Wall panel on the wall fixing profile and adjust the distance holder until the Rockfon Eclipse Wall panel is level. See 11 - Detail.

3. RECTANGULAR

(1760 x 1160 mm)

1 – 1760 x 1160

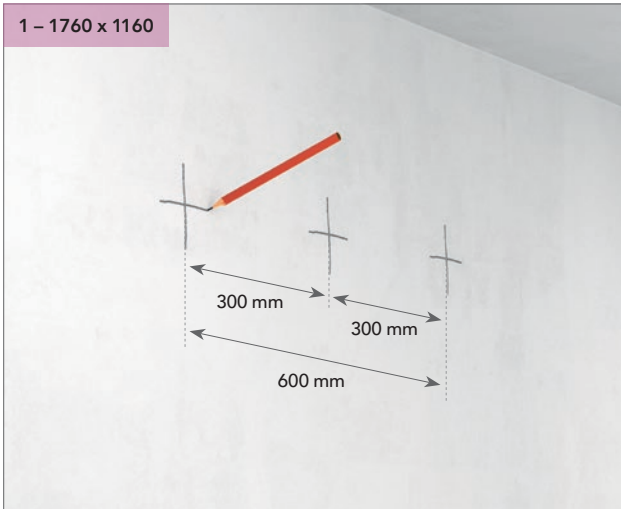

Mark crosses on the wall to indicate where you intend to fix your Rockfon Eclipse Wall panel. Draw a cross 300 mm from each side of the middle fixing point. Make sure the upper legs of the crosses are +/- 30 cm.

1 – 2360 x 1160

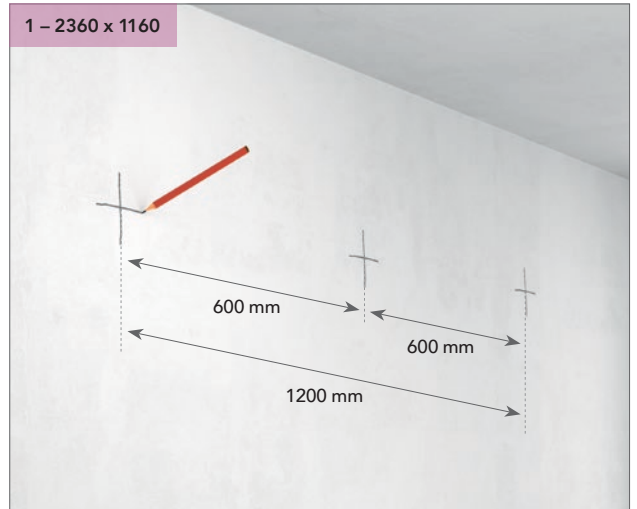

Mark crosses on the wall to indicate where you intend to fix your Rockfon Eclipse Wall panel. Draw a cross 600 mm from each side of the middle fixing point. Make sure the upper legs of the crosses are +/- 30 cm.

2

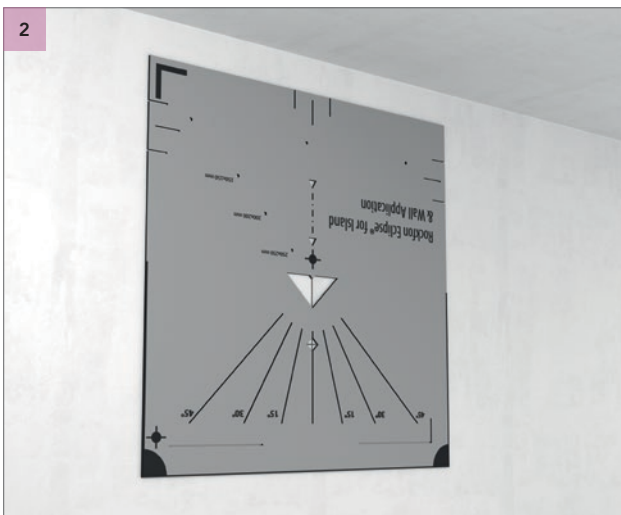

Place the marking tool above the crosses drawn on each side of the midpoint in step 1. Ensure that the centre of the cross aligns with the middle of the diamond cutout. See 2 - Detail.

2 – Detail

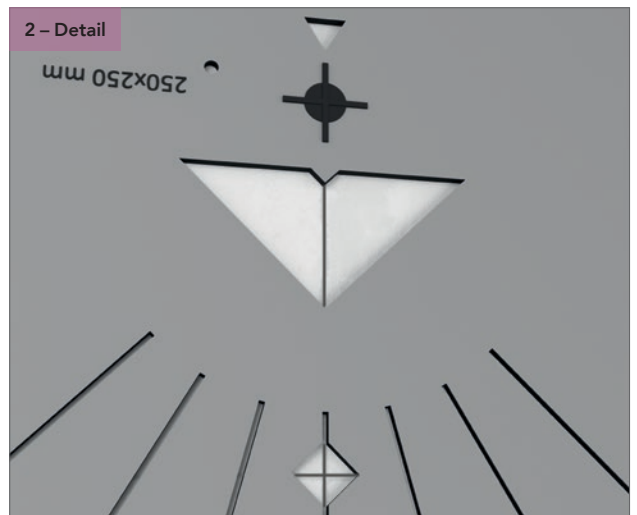

3

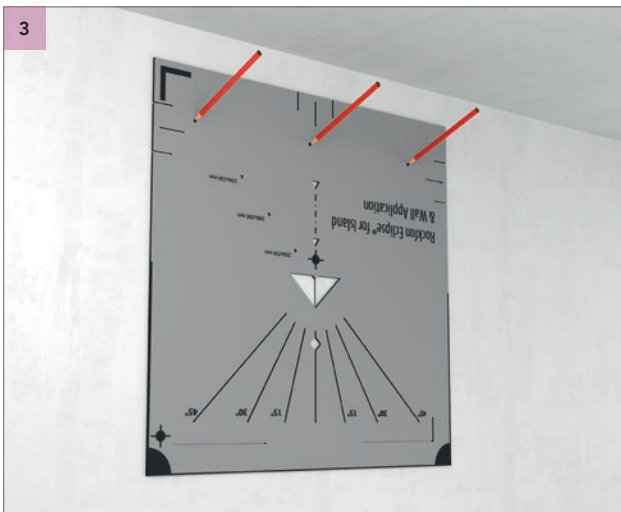

Mark the drilling holes.

3. RECTANGULAR

(1760 x 1160 mm)

4 – 1760 x 1160



Drill the holes and install the wall fixing profile.

5

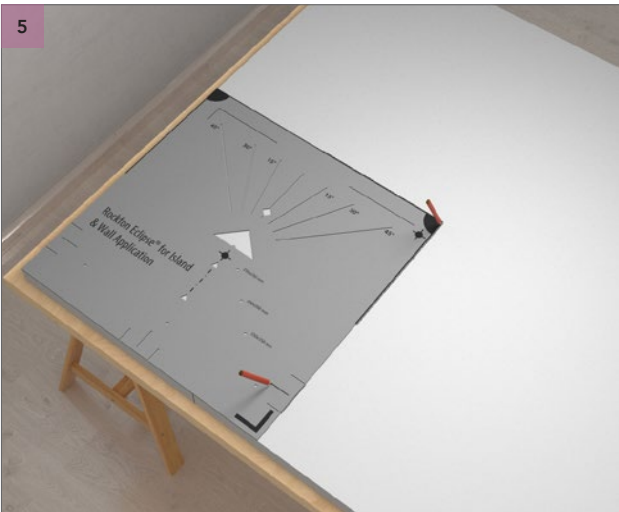

Position the marking tool in the lower left corner on the back side of the Rockfon Eclipse Wall panel. Mark with a pencil the centre lines, using the upper right corner of the marking tool, and the position of the distance holder. See 5 - Result.

5 – Result



5



Position the marking tool in the lower right corner on the back side of the Rockfon Eclipse Wall panel. Mark with a pencil the centre lines, using the upper left corner of the marking tool, and the position of the distance holder.

3. RECTANGULAR

(1760 x 1160 mm)

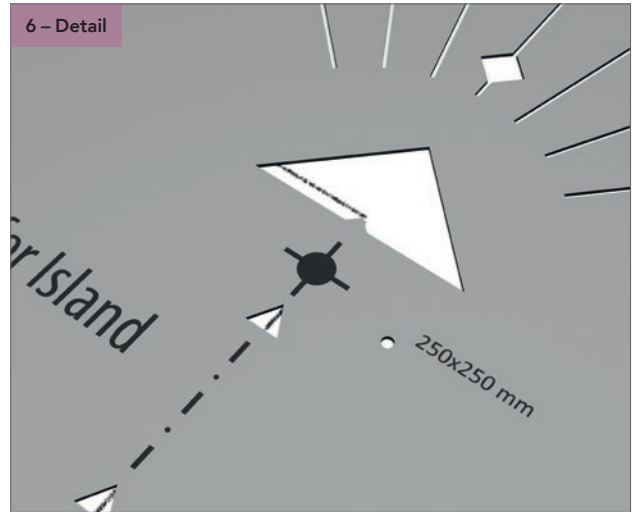
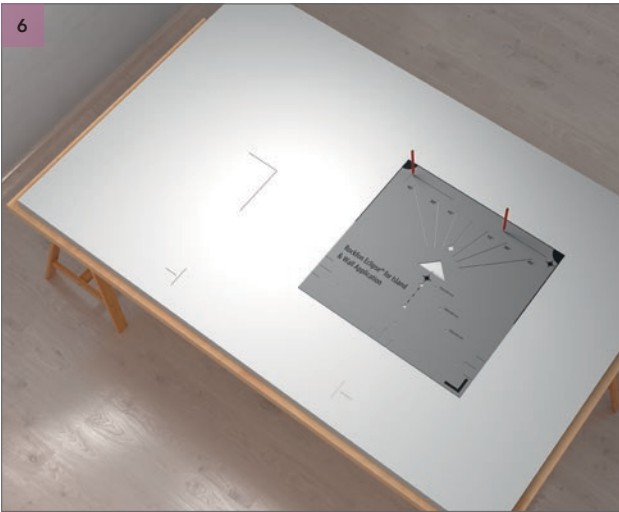

Position the marking tool so that the centre lines drawn in step 5 are perfectly aligned with the point at the base of the triangle on the marking tool. See 6 - Detail.



Mark the line where the panel fixing profile must be inserted. Do this to both the right and left side of the wall panel. See 7 - Result.

Now repeat steps 5 up to 7 for the lower right corner.

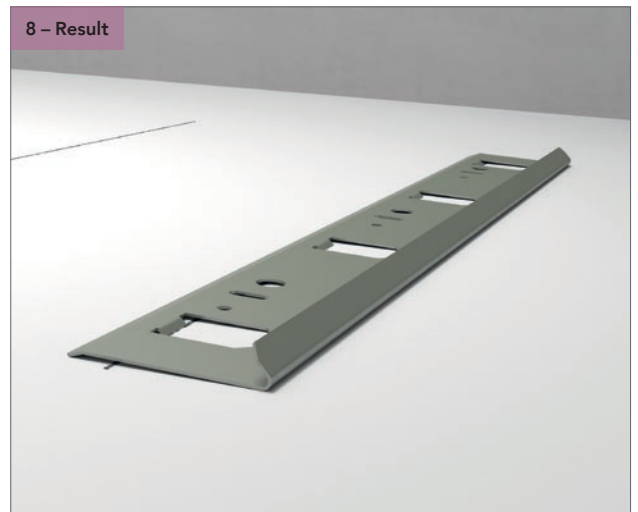
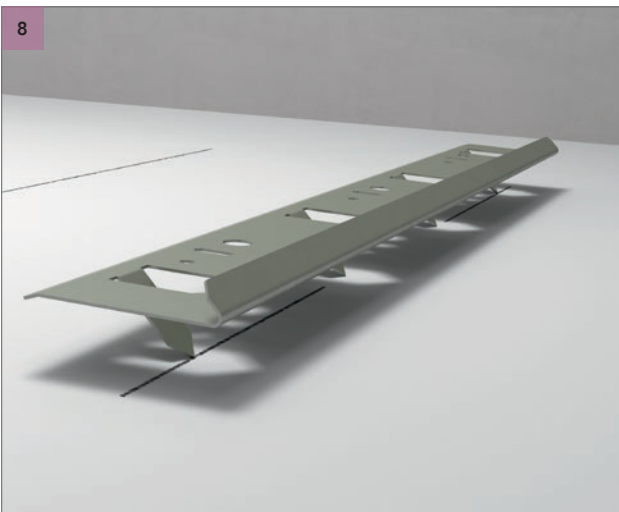

Insert the panel fixing profile into the wall panel. See 8 - Result.

3. RECTANGULAR

(1760 x 1160 mm)

8 – Result

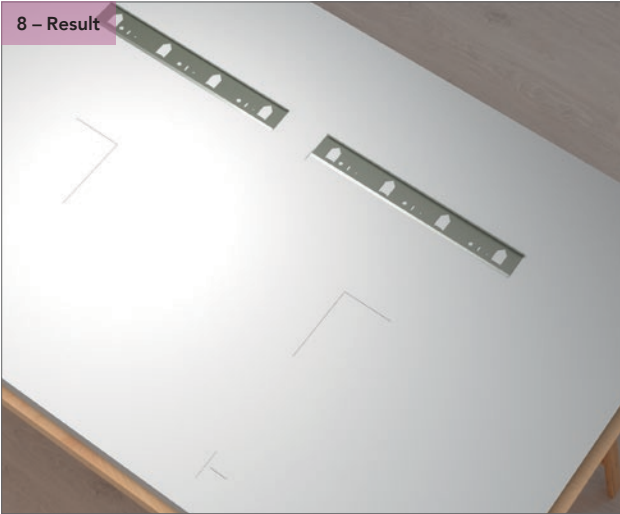

9

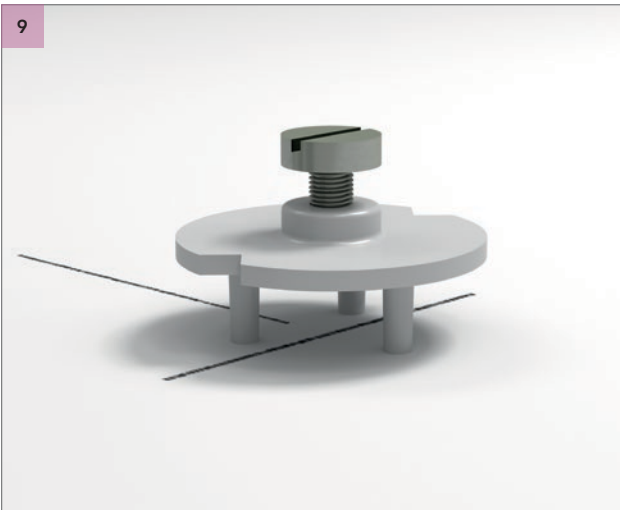

9 – Result

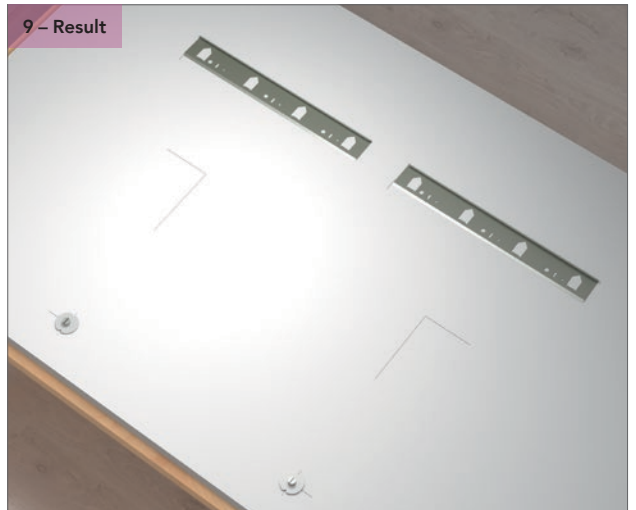

Insert the distance holders into the backside of the wall panel. See 9 - Result.

10



10 – Detail



Place your Rockfon Eclipse Wall panel on the wall fixing profile and adjust the distance holder until the Rockfon Eclipse Wall panel is level. See 10 - Detail.

4. CIRCLE (800 MM)

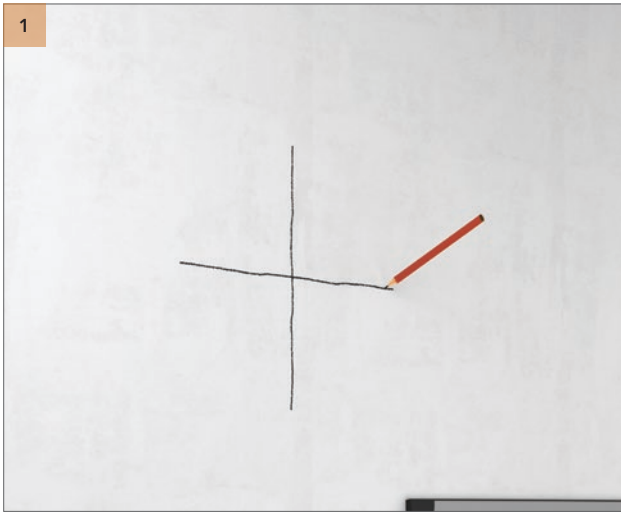

Mark a cross on the wall to indicate where you intend to fix the centre of your Rockfon Eclipse Wall panel. Make sure the upper leg of the cross is +/- 30 cm.

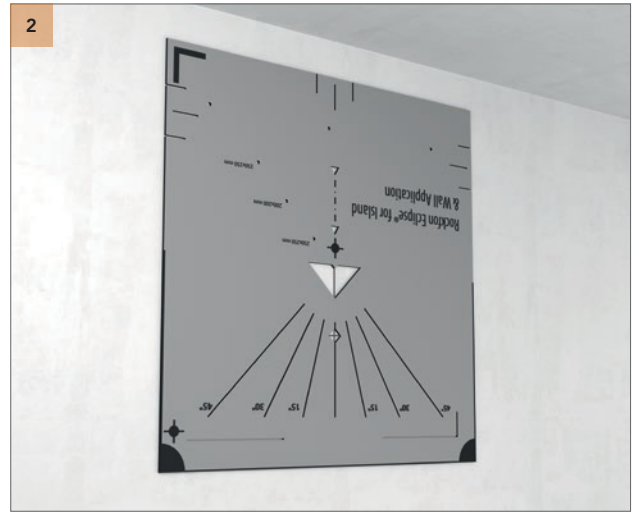

Place the marking tool above the cross drawn in step 1. Ensure that the centre of the cross aligns with the middle of the diamond cutout. See 2 - Detail.

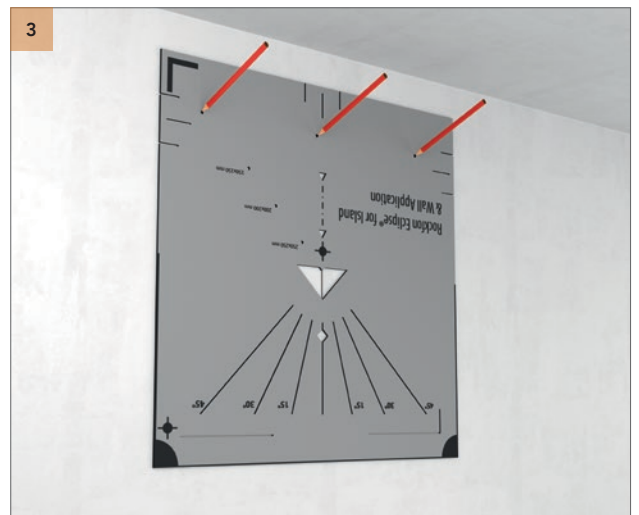
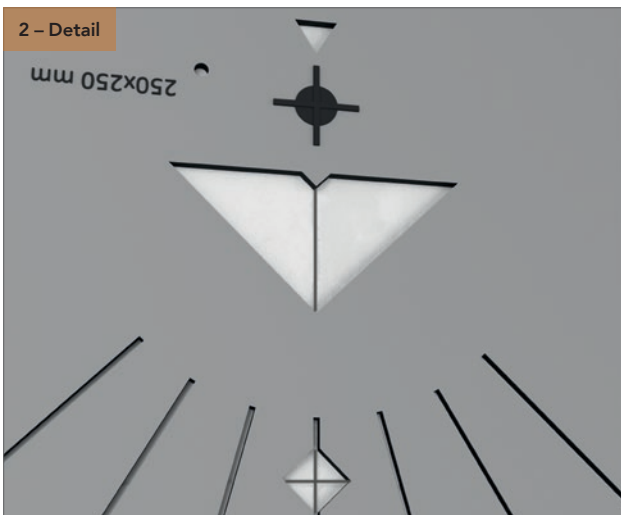

Mark the drilling holes.



Drill the holes and install the wall fixing profile.

4. CIRCLE (800 MM)

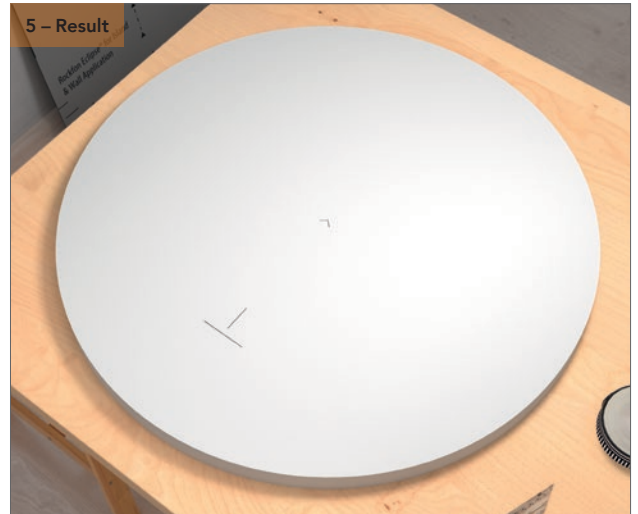
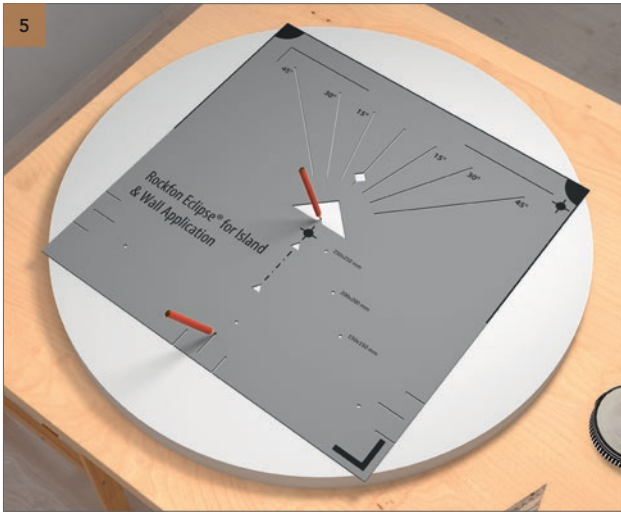

Position the marking tool on the backside of the wall panel and mark with a pencil the base of the triangle and the position of the distance holder. See 5 - Result.

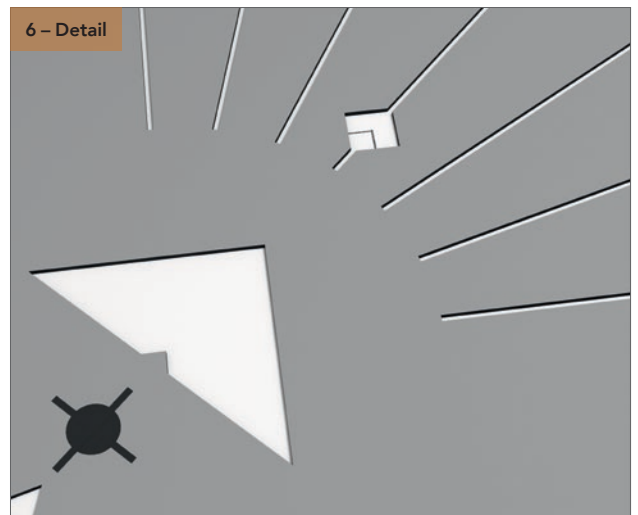

Position the marking tool so that the lines from step 5, drawn around the base of the triangle of the marking tool, are perfectly aligned within the diamond cutout. See 6 - Detail.

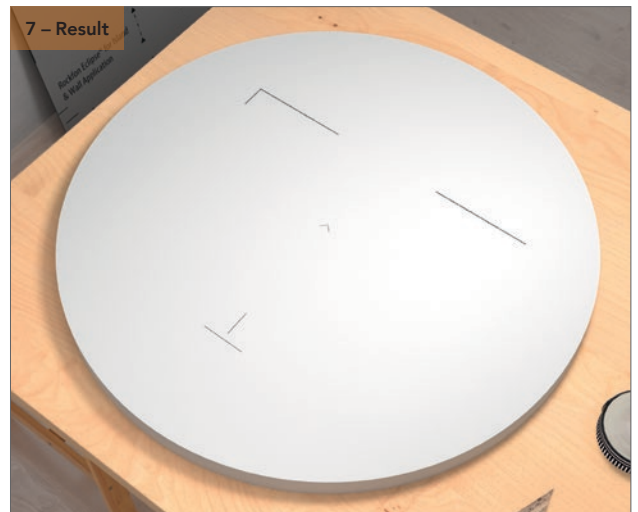
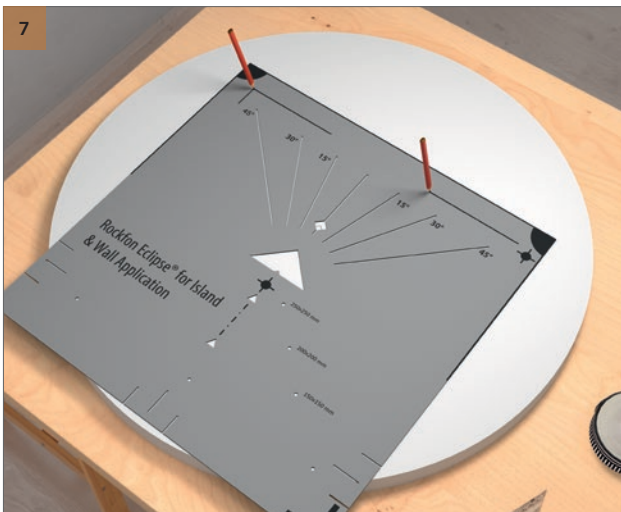

Mark the lines where the panel fixing profile must be inserted. See 7 - Result.

4. CIRCLE (800 MM)

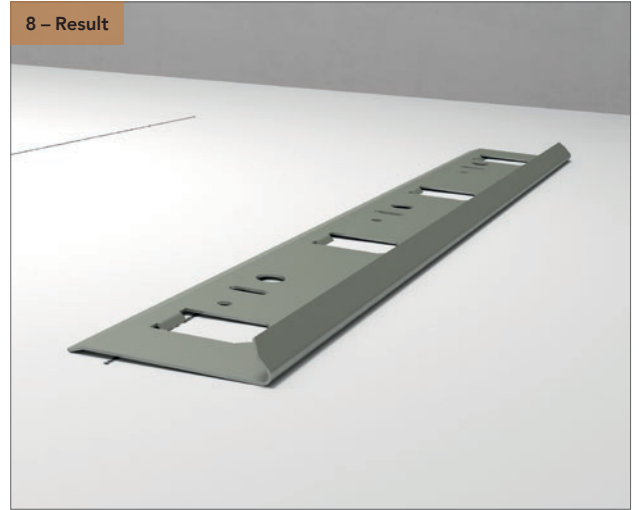
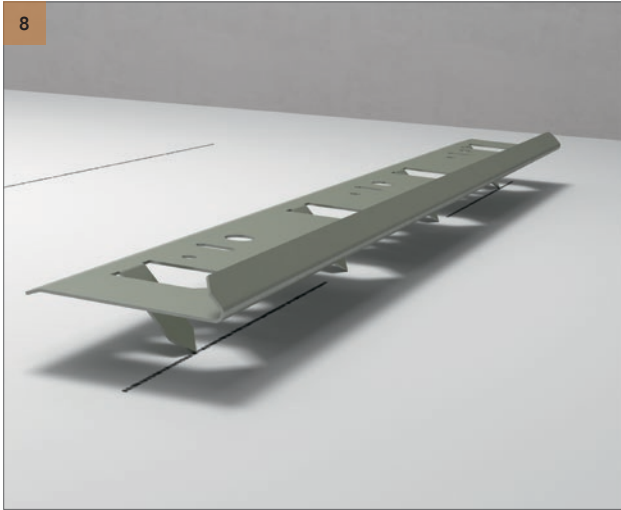

Insert the panel fixing profile into the wall panel. See 8 - Result.

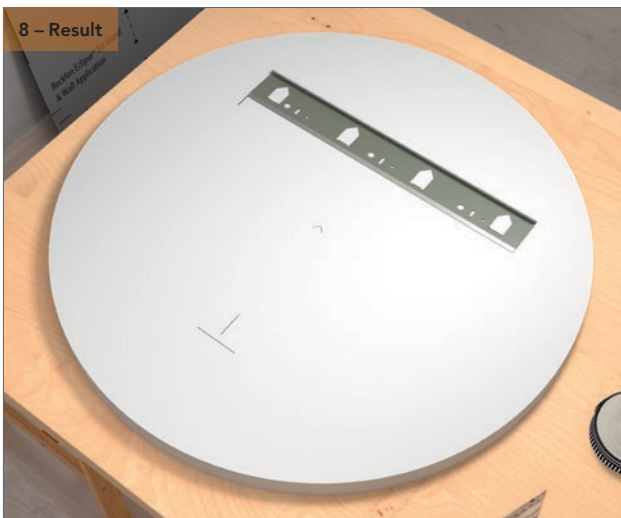

4. CIRCLE (800 MM)

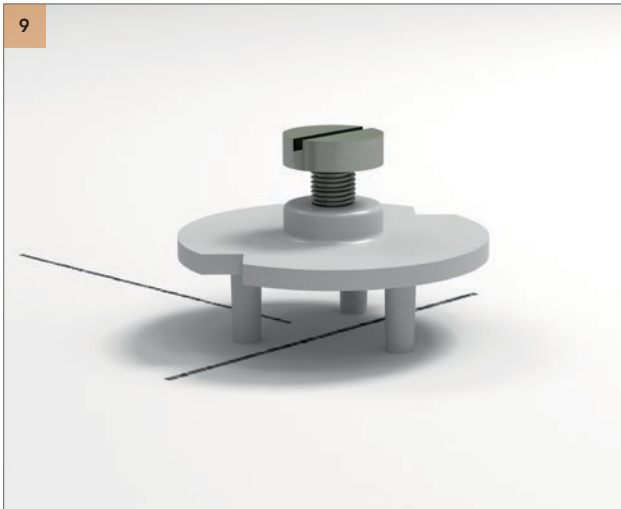

Insert the distance holder into the backside of the wall panel. See 9 - Detail.

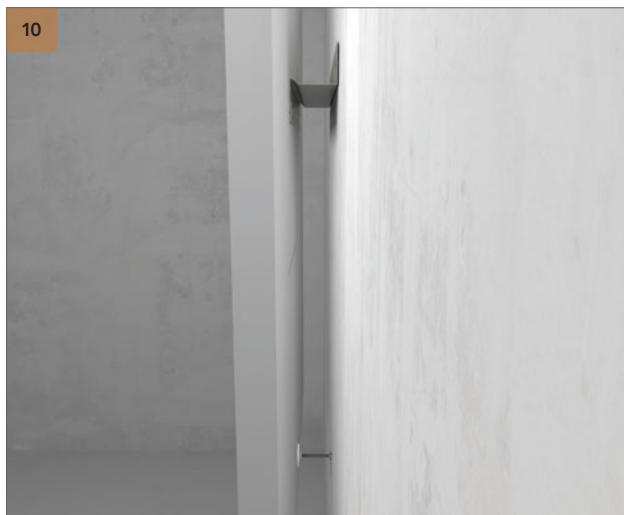

Place your Rockfon Eclipse Wall panel on the wall fixing profile and adjust the distance holder until the Rockfon Eclipse Wall panel is level.



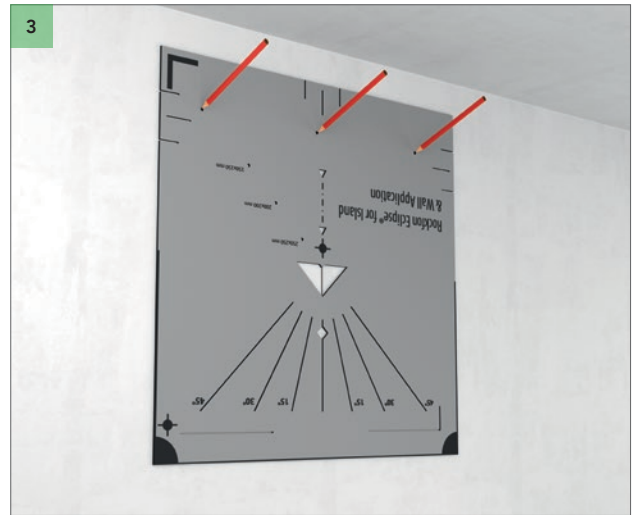
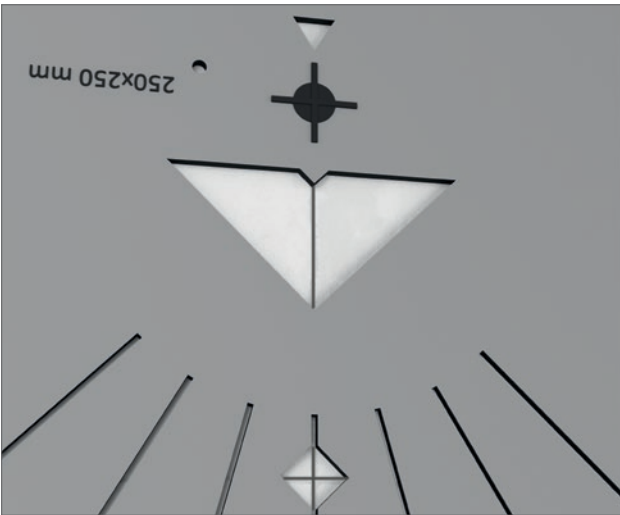
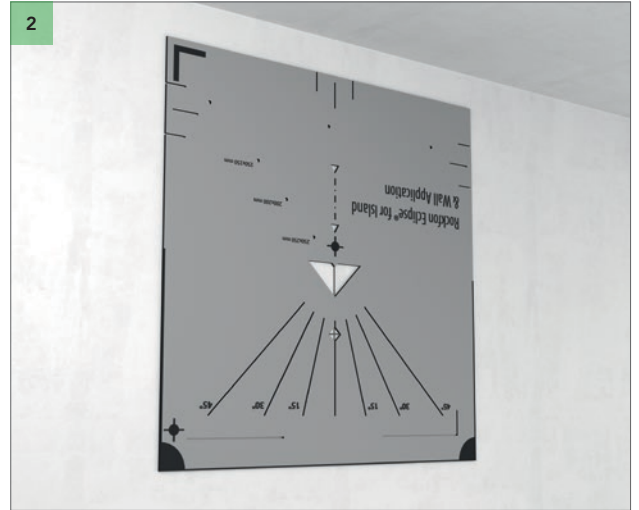
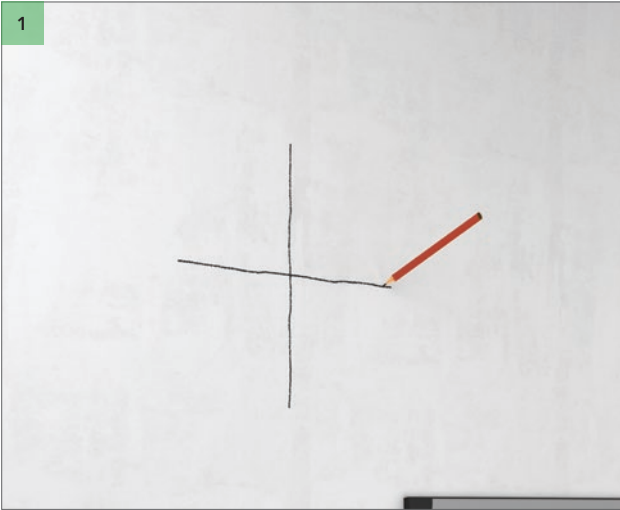

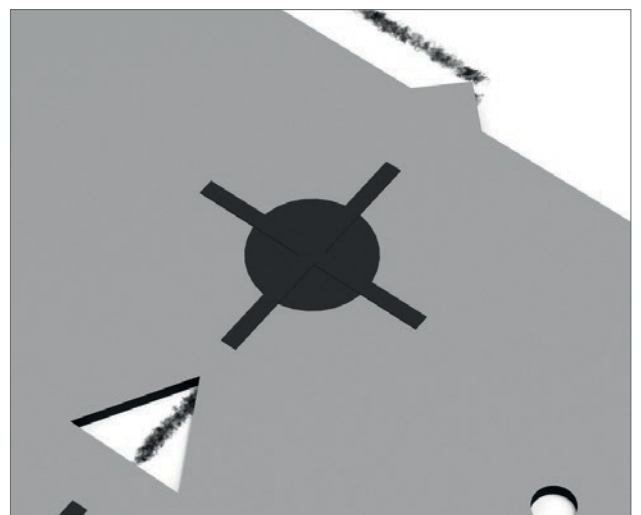
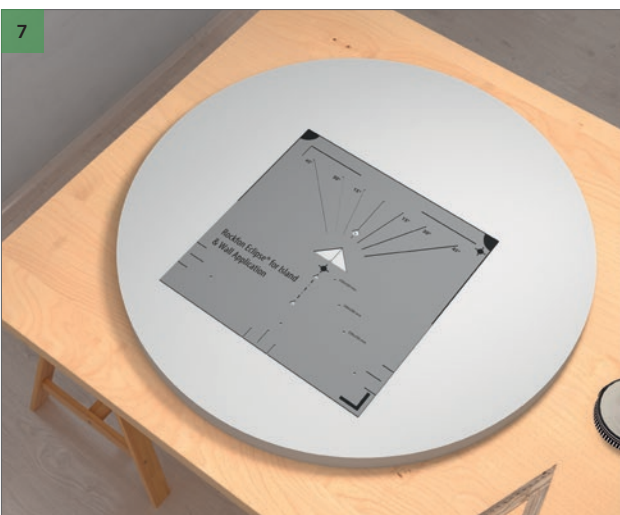
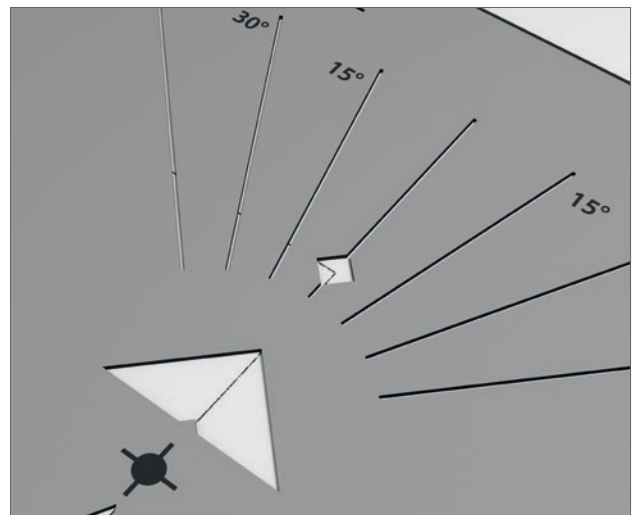
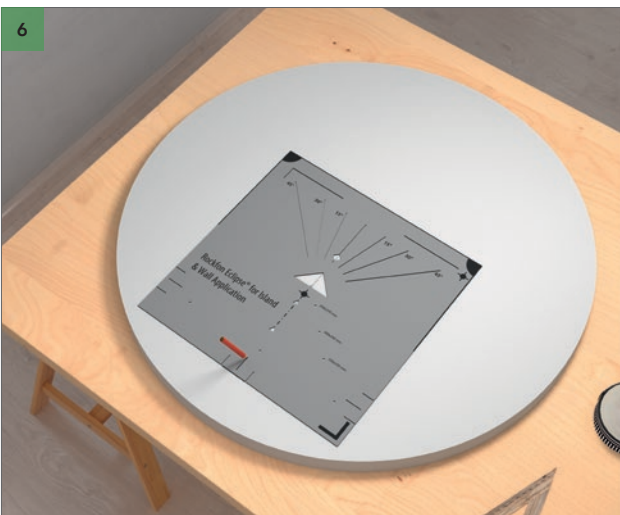
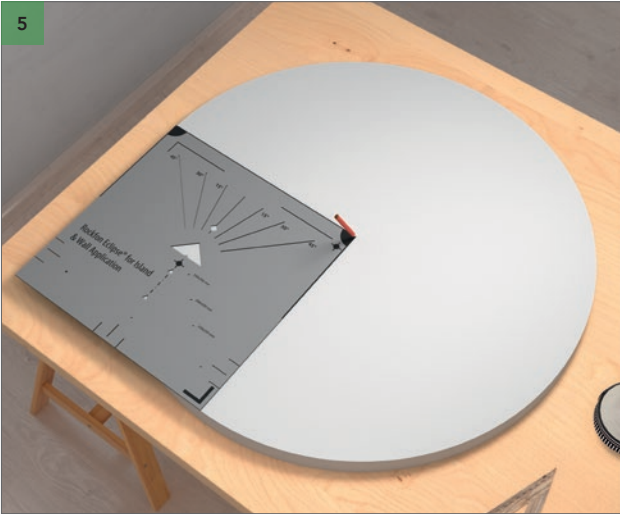

*DELETE
THIS
PAGE*

*DELETE
THIS
PAGE*

*DELETE
THIS
PAGE*

*DELETE
THIS
PAGE*

*DELETE
THIS
PAGE*

*DELETE
THIS
PAGE*

*DELETE
THIS
PAGE*

*DELETE
THIS
PAGE*

*DELETE
THIS
PAGE*

*DELETE
THIS
PAGE*

Rockfon Eclipse and Rockfon Contour® edge repair filler

Edge repair filler for making good accidental edge damage caused during on-site handling or installation.

This filler was developed to repair dents or small holes, up to 15 mm diameter, or scratches that may be caused during product mishandling.

The fillers structure and colour is identical to factory applied Rockfon Eclipse and Rockfon Contour edge paint, making site repairs virtually undetectable.

It is easy to apply and fast drying.



Tools

Rockfon has developed specific tools that are available on www.rockfon.asia



Visit our online CAD Library or BIM portal to assist you in your project design.

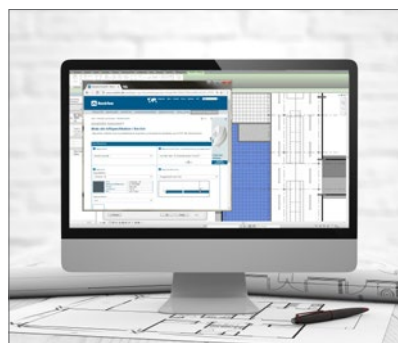

Generate specification texts for our products on our website.



Explore our vast library of reference projects on our website.

Rockfon® is a registered trademark
of the ROCKWOOL Group.

 [linkedin.com/company/Rockfon-as](https://www.linkedin.com/company/Rockfon-as)

 [pinterest.com/Rockfon](https://www.pinterest.com/Rockfon)

 [youtube.com/RockfonOfficial](https://www.youtube.com/RockfonOfficial)

 [facebook.com/RockfonOfficial](https://www.facebook.com/RockfonOfficial)

 [instagram.com/Rockfon_Official](https://www.instagram.com/Rockfon_Official)

10.2021 | All colour codes mentioned are based on the NCS - Natural Colour System® property of and used on
license from NCS Colour AB, Stockholm 2012 or the RAL colour standard. Subject to alterations in range and product
technology without prior notice. Rockfon accepts no responsibility for printing errors.

Sounds Beautiful

Rockfon Singapore

ROCKWOOL Building Materials
(Singapore) Pte Ltd.
No. 7, Tuas Avenue 1
Jurong Town,
Singapore 639492
Tel: (+65) 6861 4722
Fax: (+65) 6862 3533
E-mail: enquiry@rockfon.com
www.rockfon.asia

Rockfon Hong Kong

ROCKWOOL Building Materials
(Hong Kong) Ltd.
Unit 301-2, 3/F, Koon Wah Building,
No.2 Yuen Shun Circuit,
Yuen Chau Kok, Shatin,
N.T., Hong Kong
Tel: (+852) 2576-6117
Mobile: (+852) 9161-7924
E-mail: enquiry@rockfon.com
www.rockfon.asia

Rockfon

ROCKWOOL Middle East FZE
Office 139, Building 6WB, DAFZA
P. O. Box 293585, Dubai, UAE

Tel: +971-4-214-6280
E-mail: rockfonme@rockfon.com
ae.rockfon.com

Rockfon

ROCKWOOL France S.A.S.
111, rue du Château des Rentiers
75013 Paris

Tel: +33 1 40 77 82 82
Fax.: +33 1 45 86 77 90
E-mail: info@rockfon.fr
www.rockfon.fr

