

INTERNAL CORNER

# Rockfon<sup>®</sup> Lamella<sup>™</sup>

How to install internal corners.

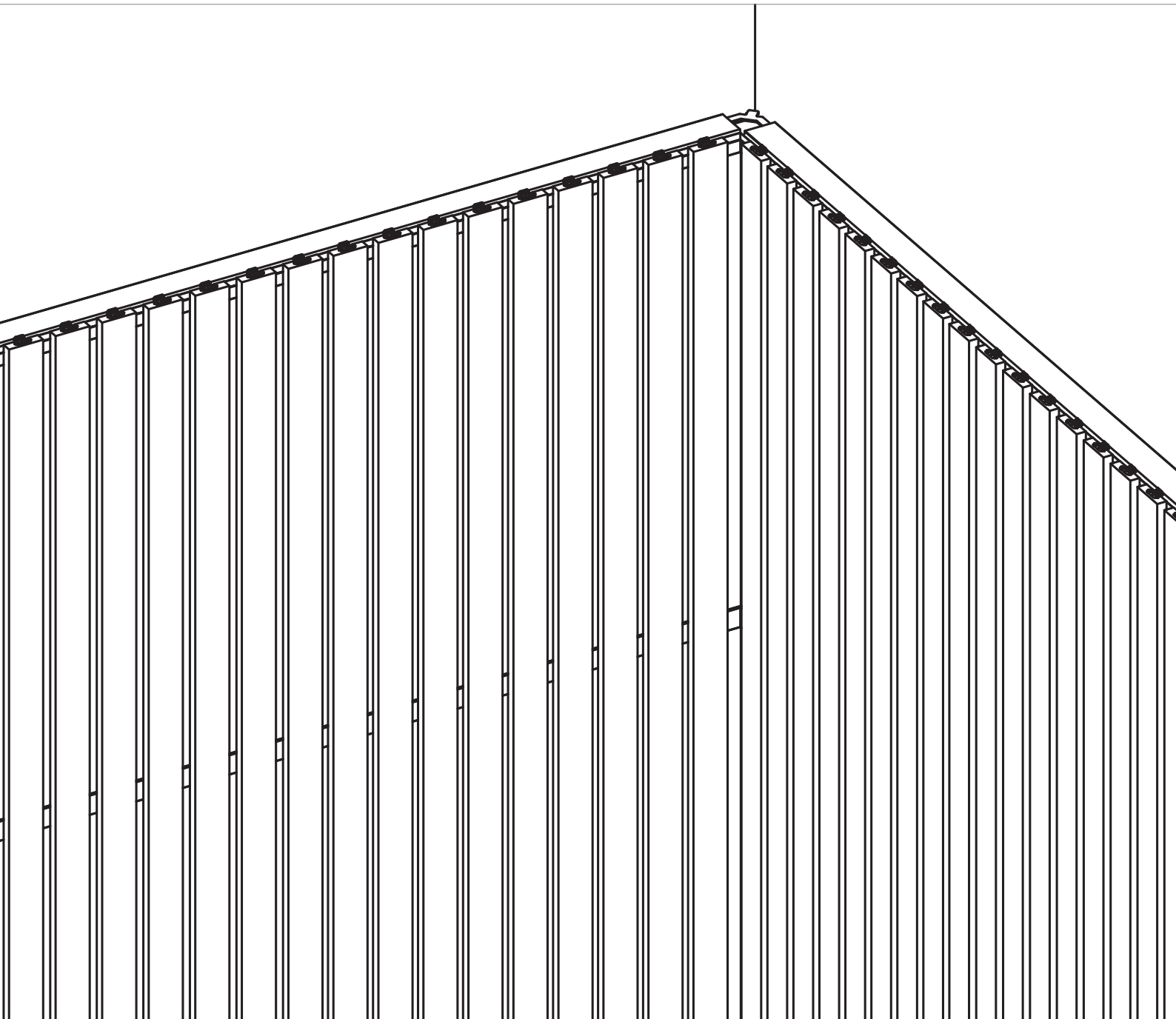

## Description

The aim is to achieve corners with the correct lamella spacing between the two inner lamellas, and to fully exploit the flexibility of the system.

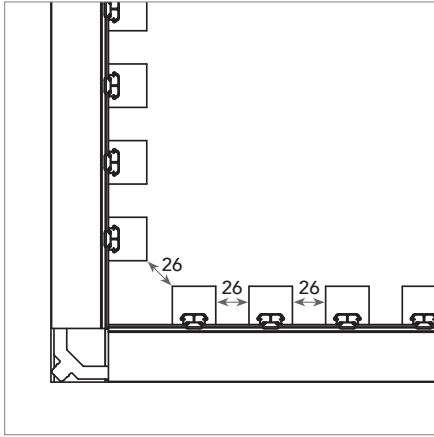

Corner with 34 x 30 lamellas.

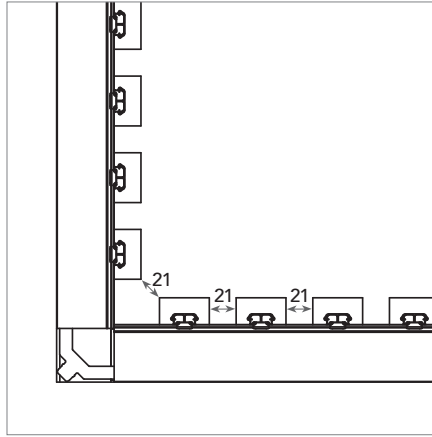

Corner with 39 x 21 lamellas.

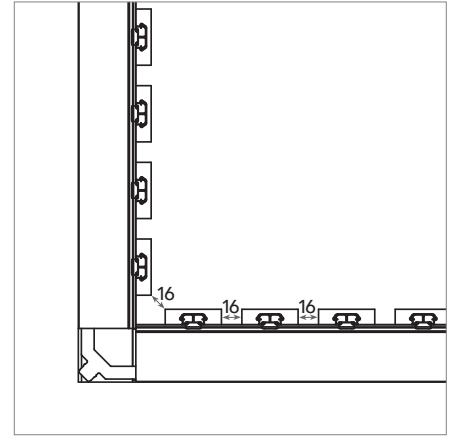

Corner with 44 x 12 lamellas.

Installation guidelines are valid for both starting at a corner and when meeting a corner.



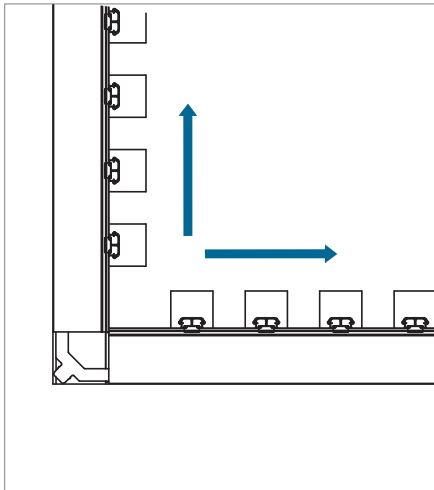



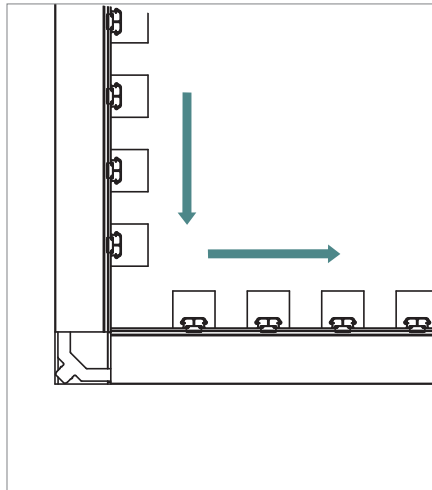

### A: Starting at an internal corner



### B: Meeting an internal corner



### Tool List

| Tools | Drill Driver  | Utility knife   | Saw   | Tape Measure  | Laser   | Level   | Screwdriver   | Pencil   |
|-------|---|---|---|---|---|---|---|--|
|       |  |  |  |  |  |  |  |  |

## Installation

- 1 If meeting a corner, you need to cut the profile to stop 42 mm from the corner.

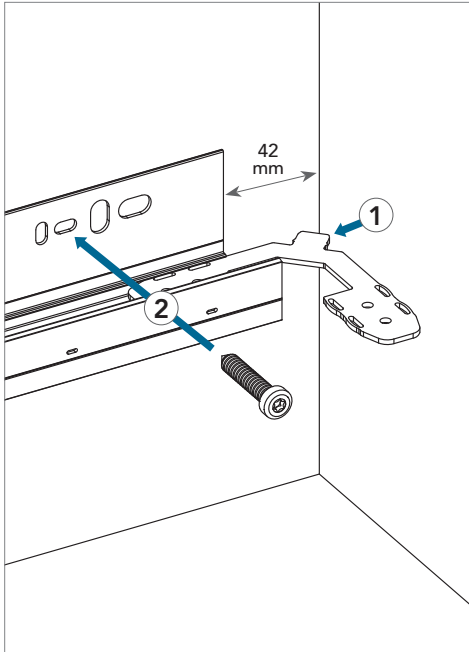

1. Insert corner connector brackets in the profiles before mounting them on the wall.
2. Space the profile end 42 mm from the corner, then fix it to the wall.
3. Repeat step 1-2 with all profiles\*.

\*If meeting a corner, and/or cutting is needed, make sure to calculate the holes of the top profile to align vertically with the other profiles

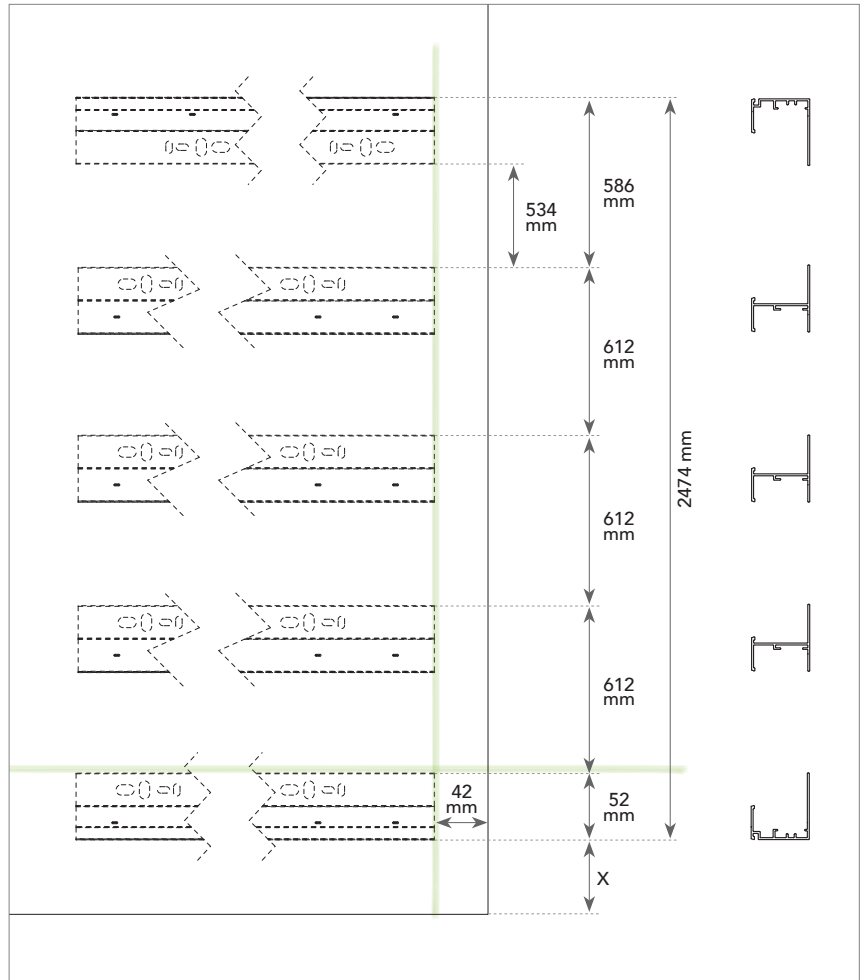

Distances between profiles.

**2** Mounting adjacent profiles.

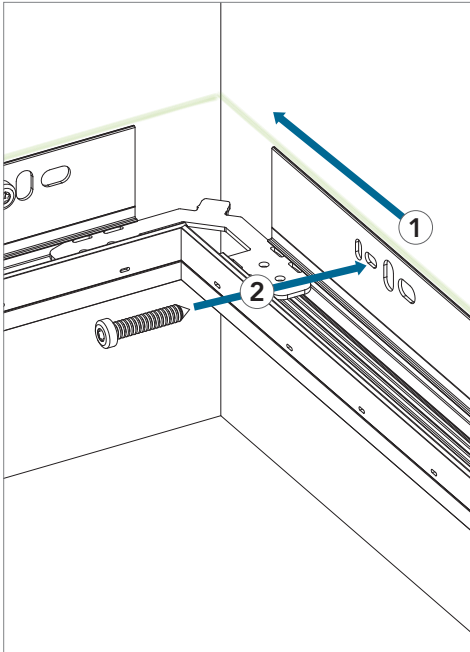

1. Slide the connecting profile on the Corner Connector Bracket, until it meets the adjacent profile.

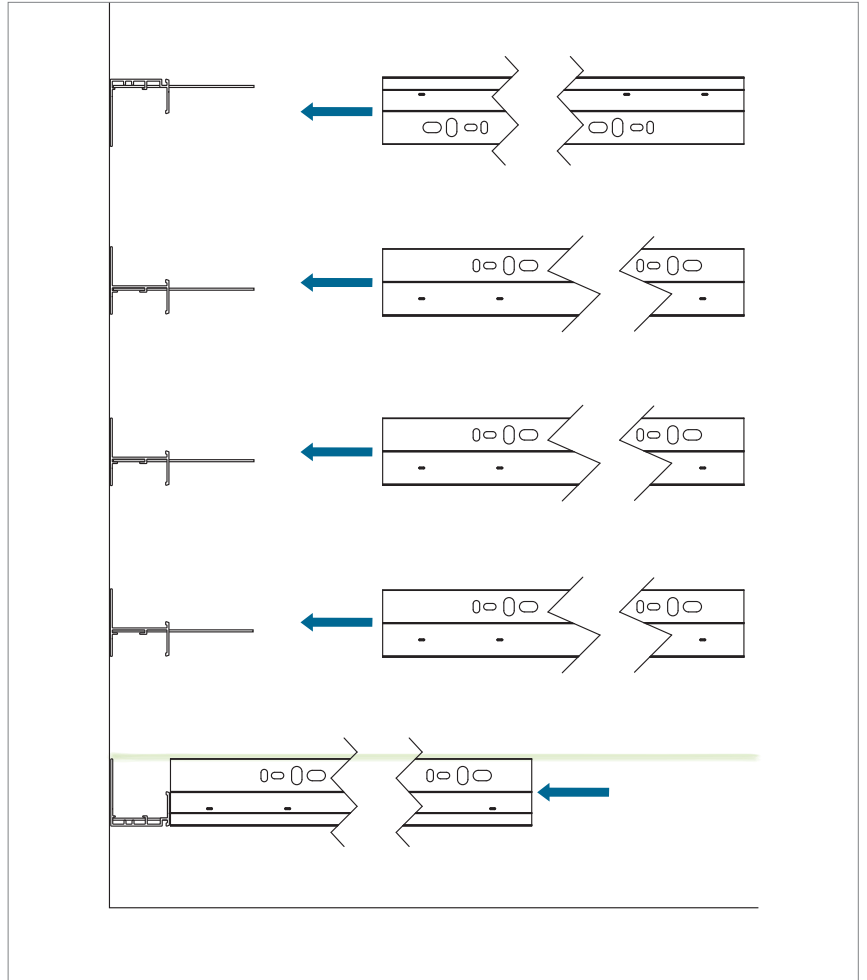

2. Align the connecting profile horizontally and fix it to the wall.  
3. Repeat with all the profiles.

3 Mounting acoustic panels.

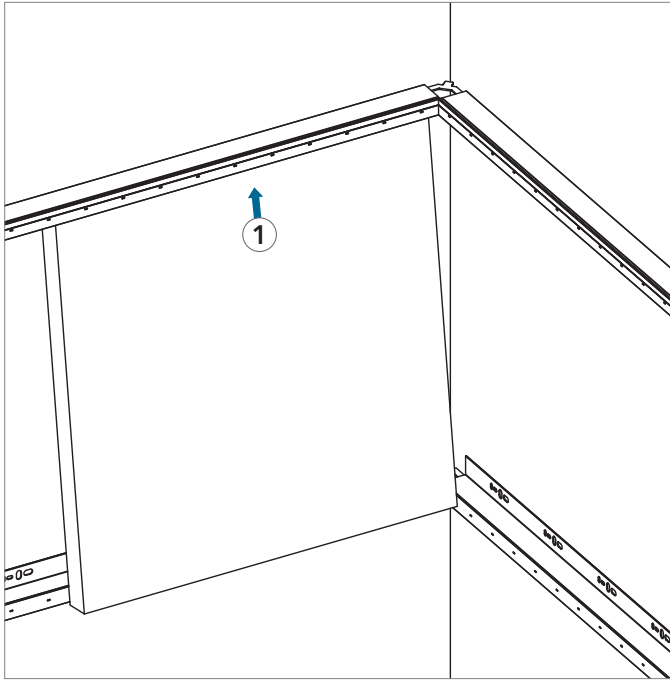

1. Put in the charcoal sound absorbing panel.  
Remember the bottom spacer in the bottom profile (see Rockfon Lamella installation guide).

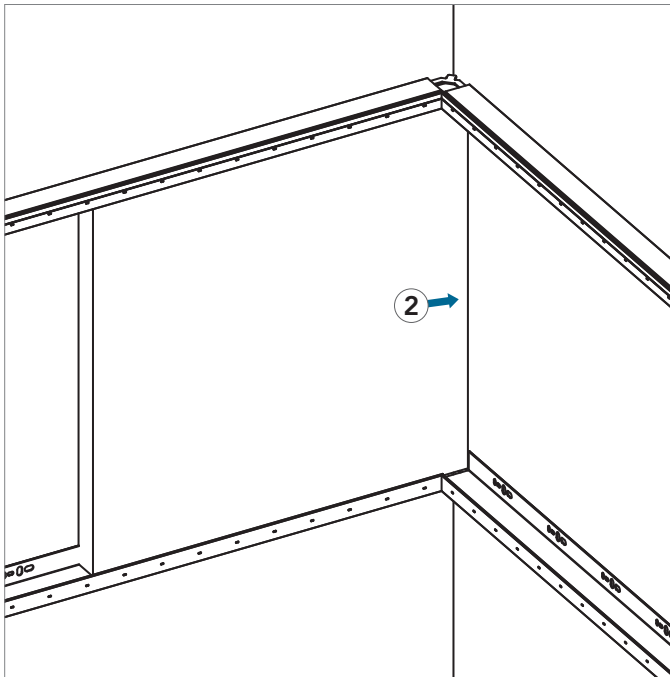

2. Slide the acoustic panel all the way into the corner, until it's stopped by the wall.

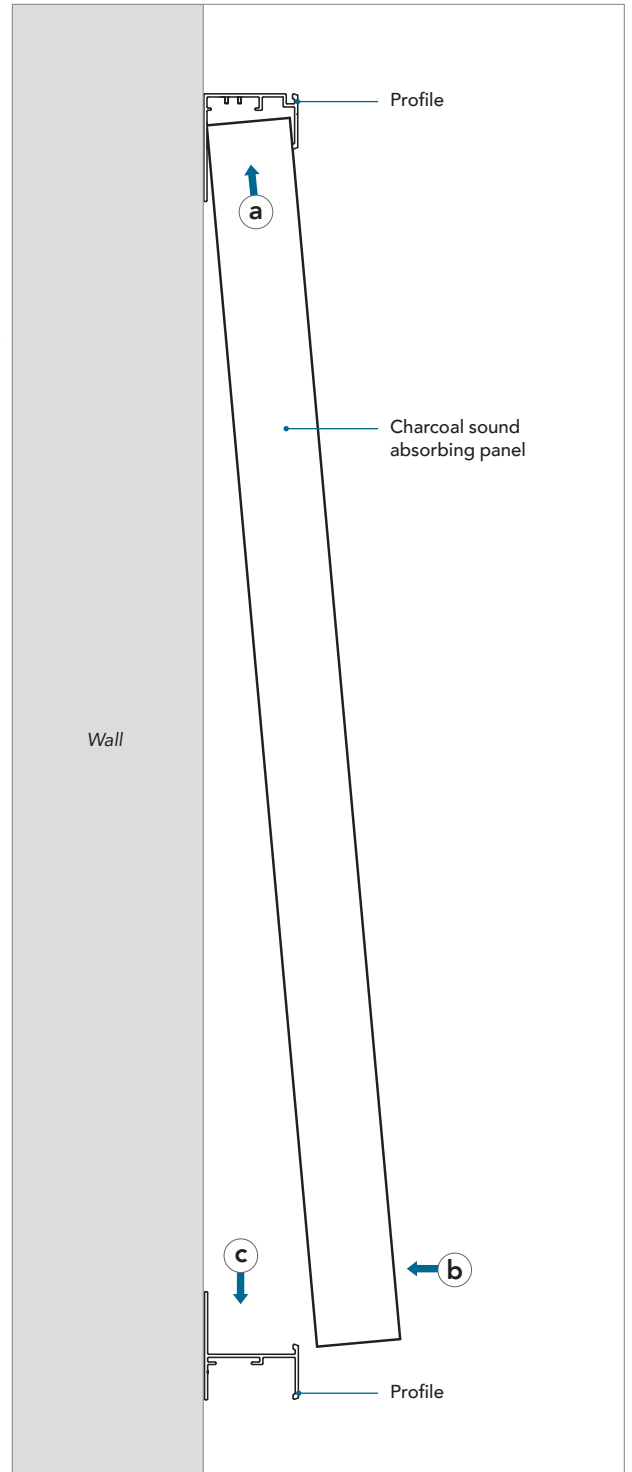

4 Mounting remaining charcoal sound absorbing panels.

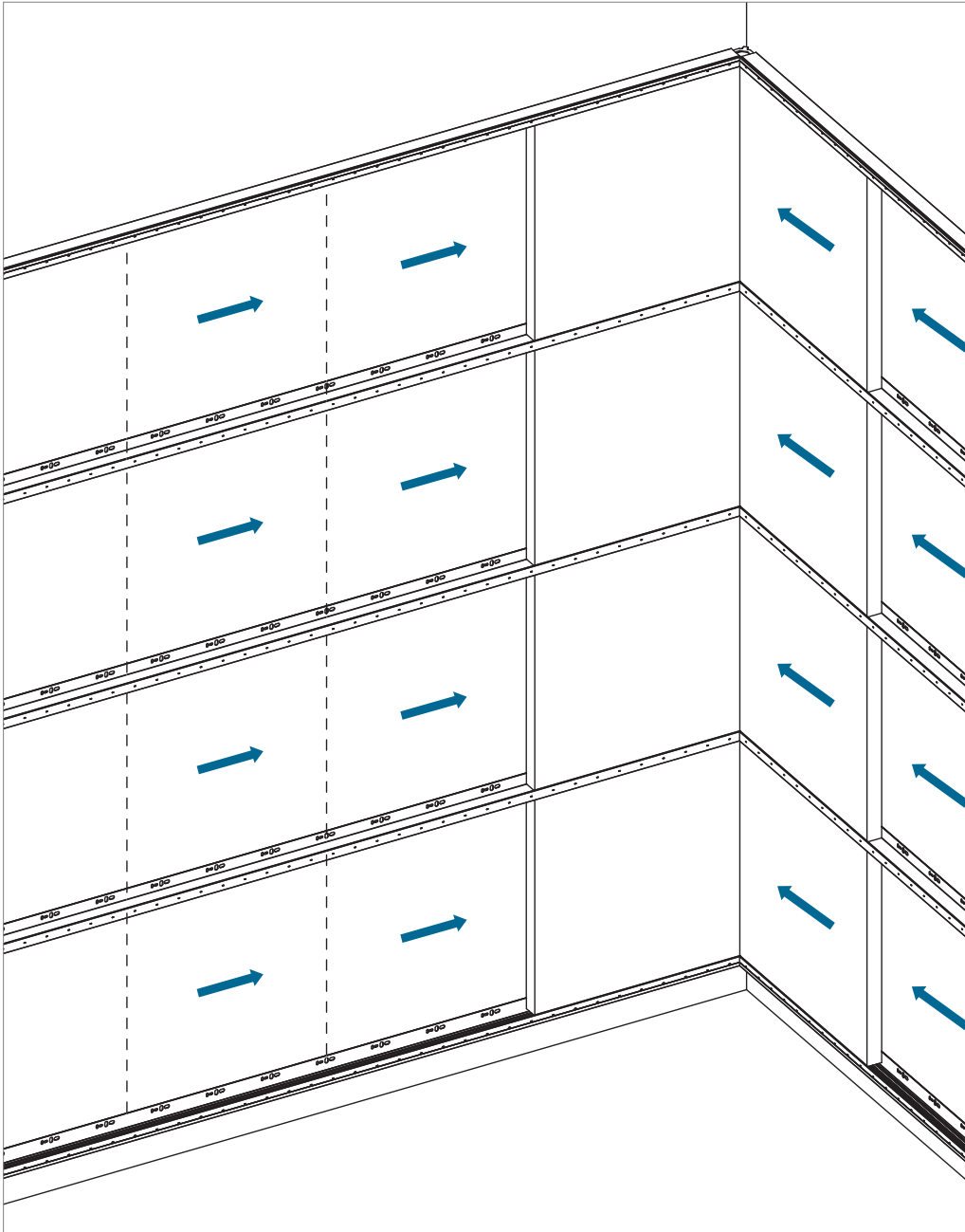

1. Put in the acoustic panel. Remember the bottom spacer in the bottom profile (see Rockfon Lamella installation guide).
2. Slide the adjacent acoustic panels all the way into the corner, until they meet the adjacent panels.
3. Fill up the open space with acoustic panels by pushing them together towards the corner.

5 Mounting 1st clips from corner.

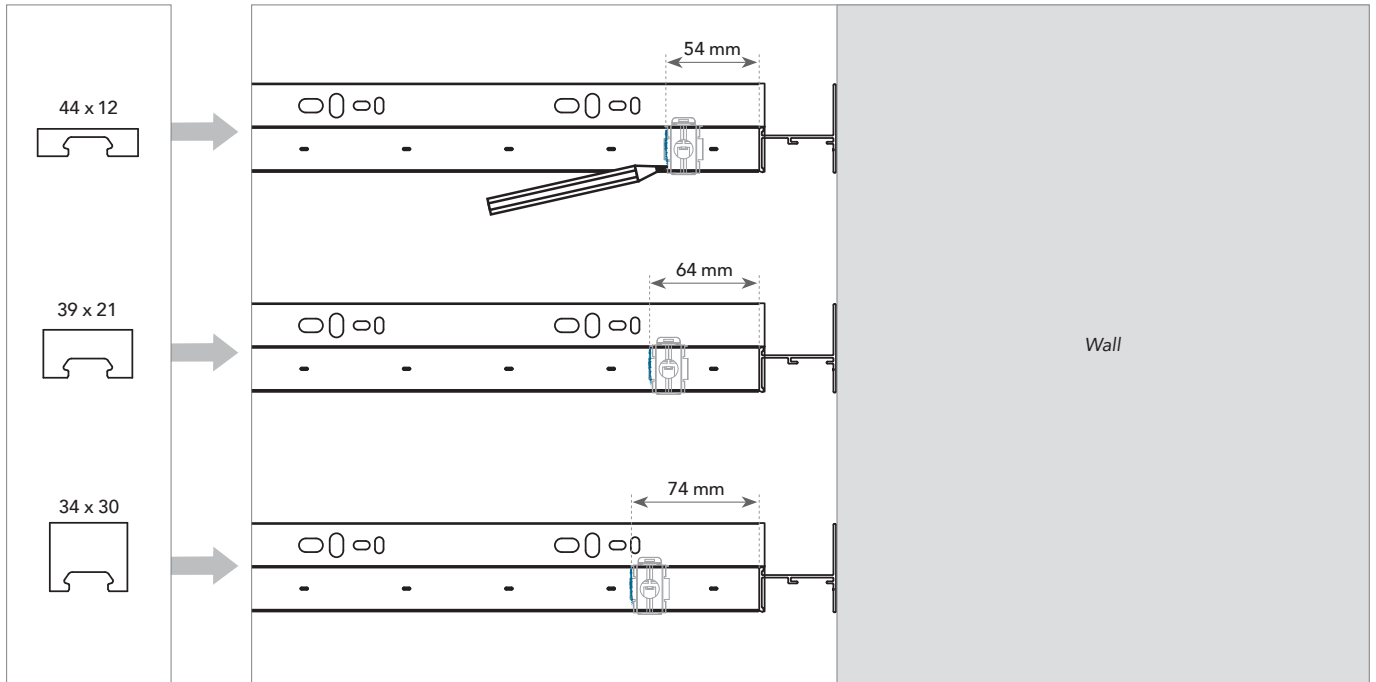

Mark an alignment line for placing the 1st inner clip. Measure from the front face of the adjacent profile. Then place the first clip. Then use the guide ruler to place the next clips until you can start use the alignment holes in the profiles

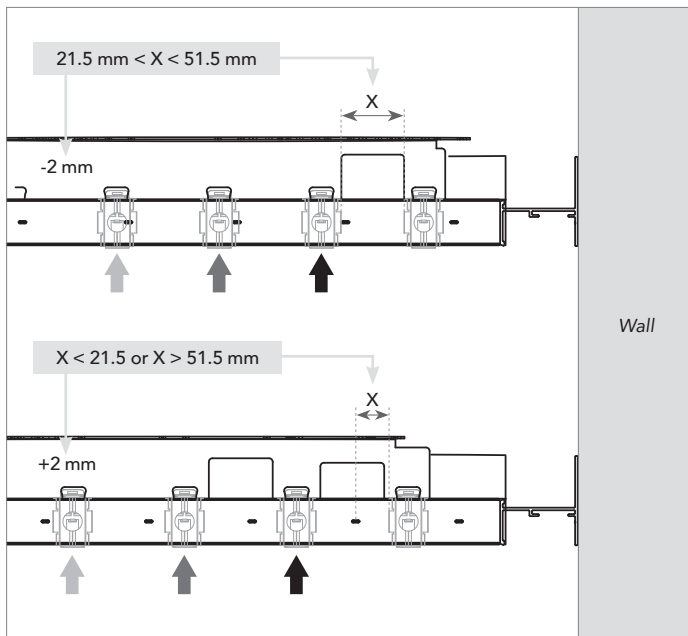

Choosing the right slots on the guide ruler:  
If the distance X is between 21.5 mm and 51.5 mm use the -2 slots on the guide ruler. If it's less or more use the +2 slots. Stop using the ruler when the clip is aligned with the holes in the profile.

**ATTENTION**

When placing a clip outside an alignment hole – push in the alignment pin on the back of the clip by using your thumb.

**6** Mounting the slats.

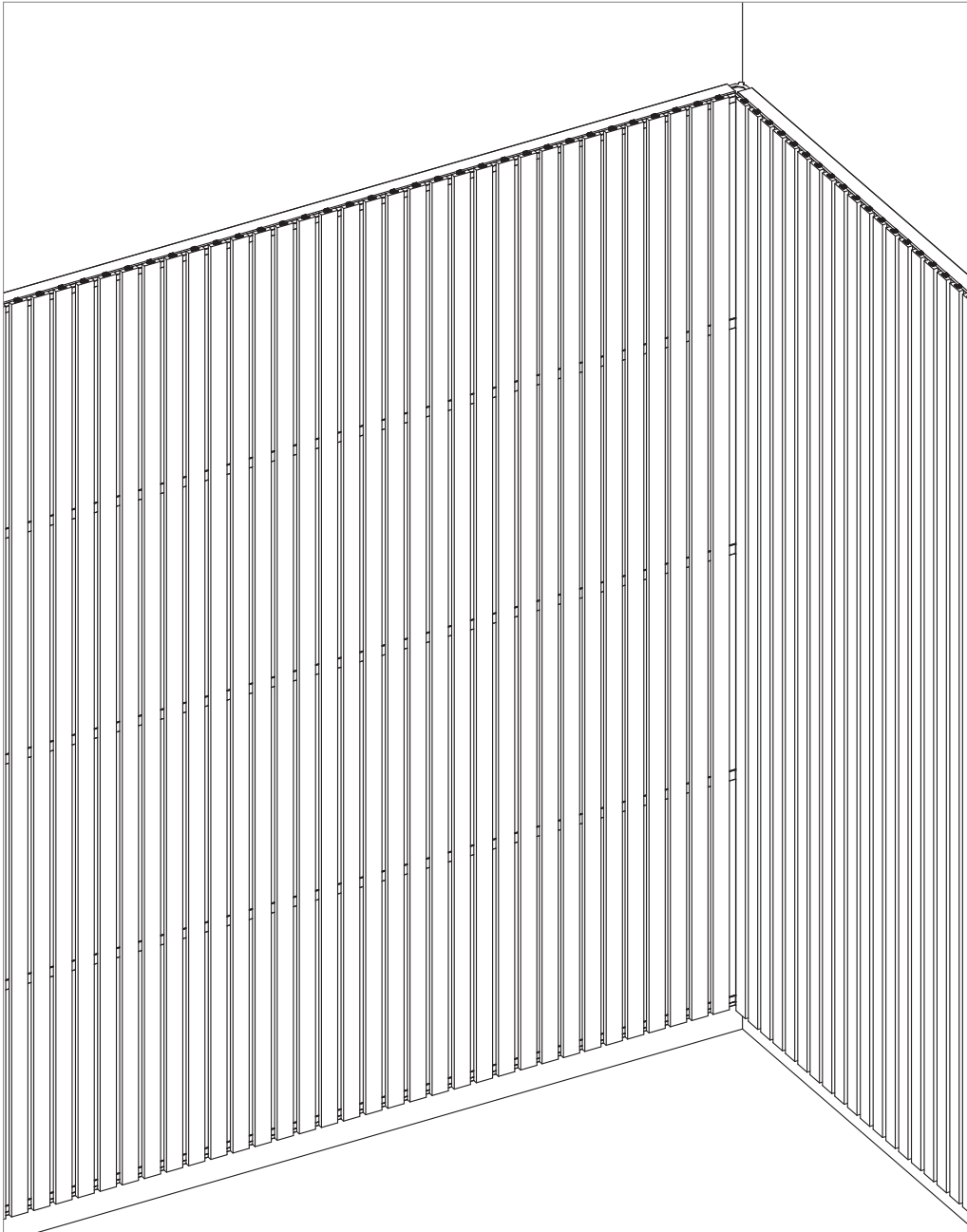

*Attach all slats on the clips (see Rockfon Lamella installation guide). The internal corner is now complete.*



01.2024 | All colour codes mentioned are based on the NCS - Natural Colour System® property of and used on license from NCS Colour AB, Stockholm 2012 or the RAL colour standard. Subject to alterations in range and product technology without prior notice. Rockfon accepts no responsibility for printing errors.

# Sounds Beautiful

