



Acoustic Lamella wall system

- Modular and ready to ship solution, designed to provide a highly creative, yet hassle free experience
- Patented modular platform provides over 650,000 different design possibilities in just one system
- Complimentary wood veneers can be combined to create attractive aesthetical expressions
- Contrasting lamella slat dimensions let you experiment with diverse relief patterns and inter-spacing ideas
- Rockfon Lamella is designed to last and look great for decades to come

Description

Rockfon Lamella is a wall mounted system available in three different plywood slat dimensions and three different wooden veneers, resulting in a choice of 9 unique slats. Each lamella slat is individually attached to a proprietary mounting platform, via the use of a patented clip. The mounting platform contains specially designed Rockfon Sound Absorbing Panels, providing the system with outstanding sound absorption properties.

By combining natural wood with our sound absorbing panels, you can create interior spaces as calm as the forest, across a wide range of building segments.

Restrictions

The maximum width of Rockfon Lamella is unlimited, thanks to the use of our specially designed Horizontal Profile Connector Brackets. We recommend restricting installations to the standard height of the mounting platform (2474 mm).

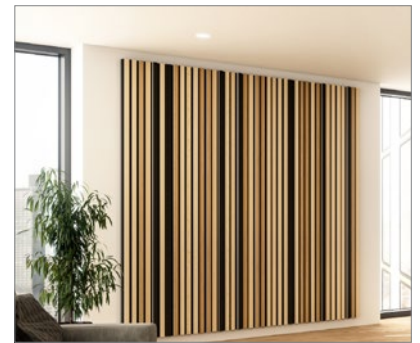
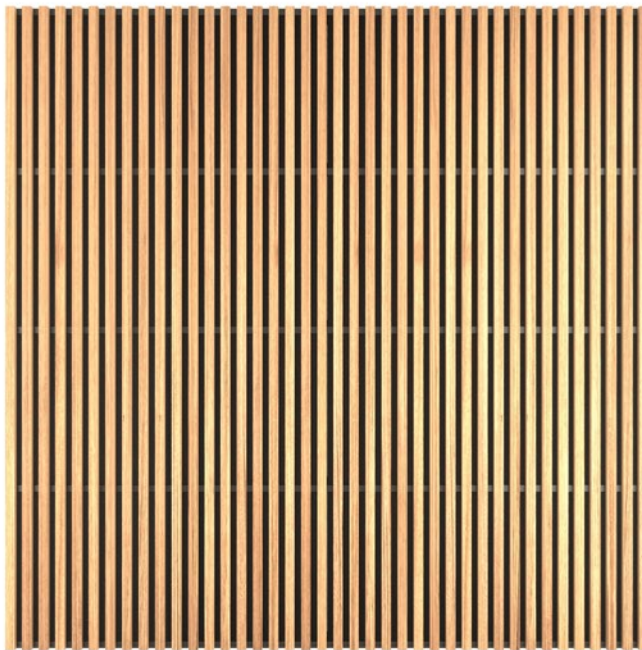

Three different slat dimensions (44 x 12 mm, 39 x 21 mm, 34 x 30 mm).



Rockfon Lamella Slat attached to the Horizontal profile.



Rockfon Lamella Sound Absorbing Panel Charcoal.

System components and consumption guide

The quantities required of the different components depend on the size of the surface area.

Here is an example for a Rockfon Lamella surface covering 2418 x 2474 mm;

Tile		Slat		Profiles				Accessories				
		1	2	3	4	5	6	7	8	9	10	
Rockfon Lamella Sound Absorbing Panel Charcoal		Rockfon Lamella Slat	Rockfon Lamella Horizontal Profile - Middle	Rockfon Lamella Horizontal Profile - Top/Bottom	Rockfon Lamella Vertical End Profile - Left/Right	Rockfon Lamella Horizontal Profile - Middle Connector Bracket*	Rockfon Lamella Vertical End Profile - End Connector Bracket	Rockfon Lamella Vertical End Profile - Set Screw	Rockfon Lamella Horizontal Profile - Bottom Spacer	Rockfon Lamella Mounting Clip	Rockfon Lamella Guiding Ruler**	
Dimensions (mm)	Consumption/m ²											
2418 x 2474 = 6 m ²	16 pcs	40 pcs	3 pcs	2 pcs	2 pcs	-	10 pcs	20 pcs	8 pcs	200 pcs	1 pcs	

*Only applicable if the width of the Rockfon Lamella wall is >2418 mm.

** One piece per project is recommended.

Rockfon Lamella Sound Absorbing Panel Charcoal

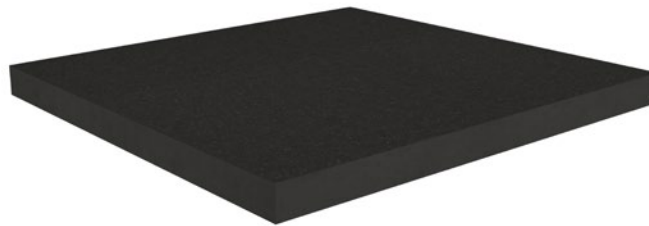

Slats

1. Rockfon Lamella Slat



Profiles

2. Rockfon Lamella Horizontal Profile - Middle



3. Rockfon Lamella Horizontal Profile - Top/Bottom



4. Rockfon Lamella Vertical End Profile - Left/Right



Accessories

5. Rockfon Lamella Horizontal Profile - Middle Connector Bracket



6. Rockfon Lamella Vertical End Profile - End Connector Bracket



7. Rockfon Lamella Vertical End Profile - Set Screw



8. Rockfon Lamella Horizontal Profile - Bottom Spacer



9. Rockfon Lamella Mounting Clip



10. Rockfon Lamella Guiding Ruler



Compatible Tiles Overview

Only Rockfon Lamella Sound Absorbing Panel Charcoal can be used for Rockfon Lamella.

Minimum installation depth (mm)

Panels, slats and clips mounted in Rockfon Lamella are fully demountable, but not re-usable.

The installation depth is defined as the distance from the front side of the slats to the wall substrate. D represents the exact installation depth.

Thickness profile	Thickness slat	D = Minimum installation depth
mm		
45	12	57
	21	66
	30	75

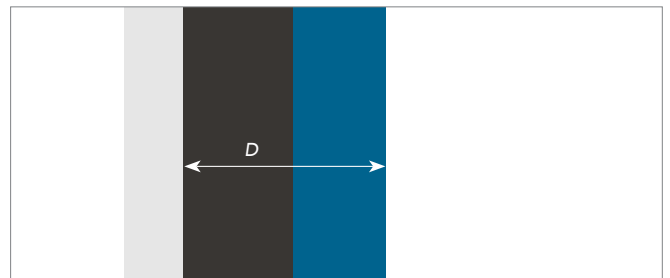

Installation

Ensure that the walls are smooth and even. Carry out any smoothing/levelling work before installation of the Rockfon Lamella. If necessary, install a framework to compensate for uneven walls. The walls upon which the wall system is to be installed must be clean and dry.

For off-floor installations, consideration should be given to using a scuff-resistant skirting or base support between the floor and bottom perimeter trim. This will reduce the likelihood of damage from shoes, luggage, vacuum cleaners or other floor-level risks.

Use mounting screws, methods and amount of fixing points appropriate for the wall material.

Quick installation for mounting Rockfon lamella

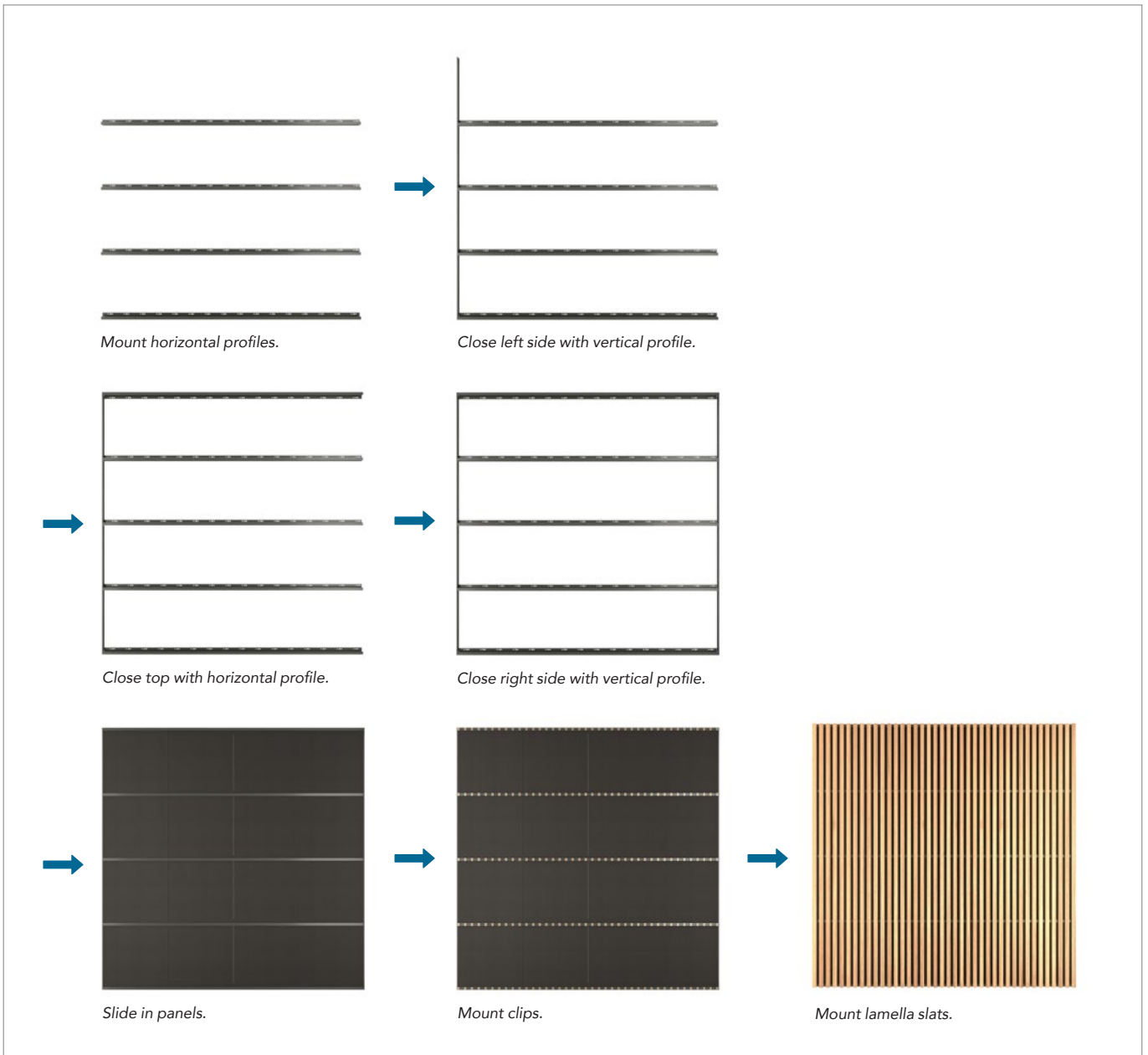

Installation steps

- 1 Mark the corners of your planned installation.

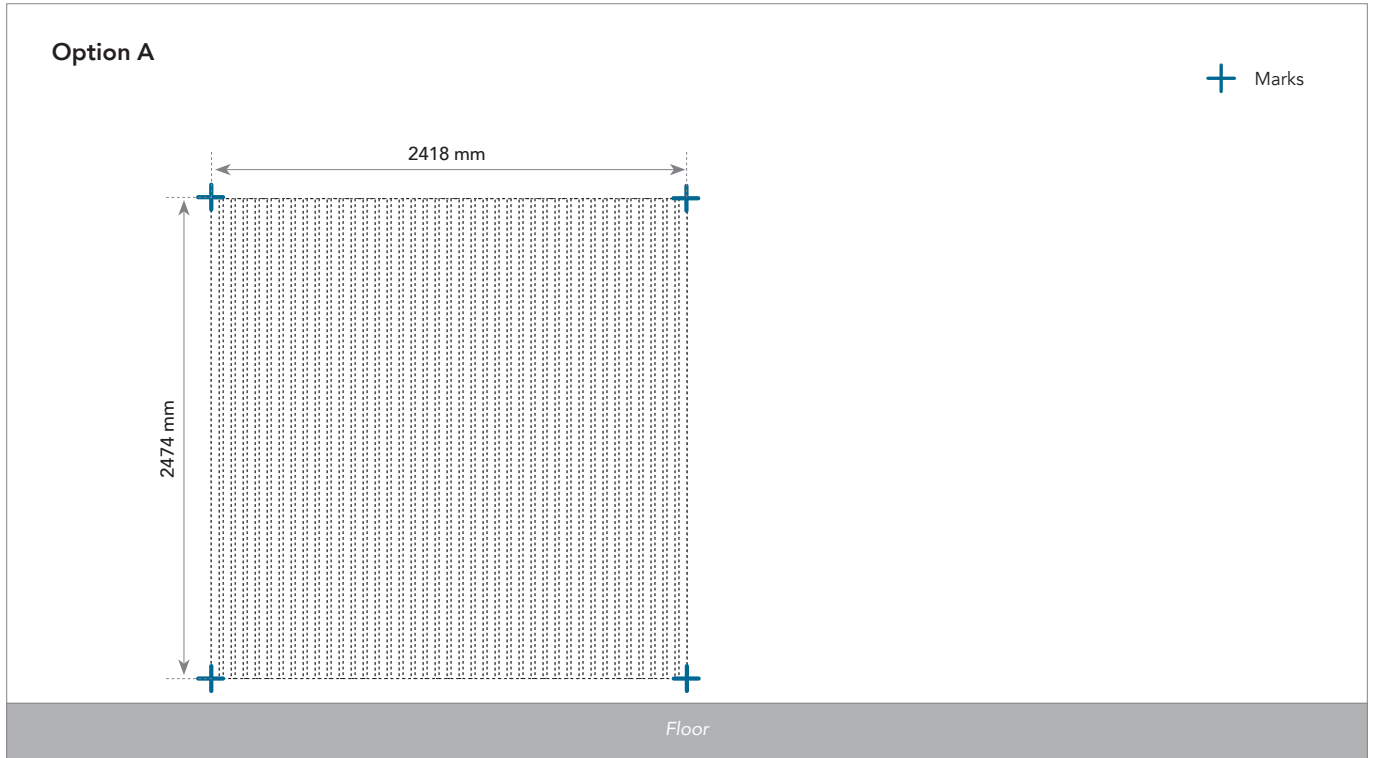

Please note that the standard and minimum width of Rockfon Lamella is 2418 mm.

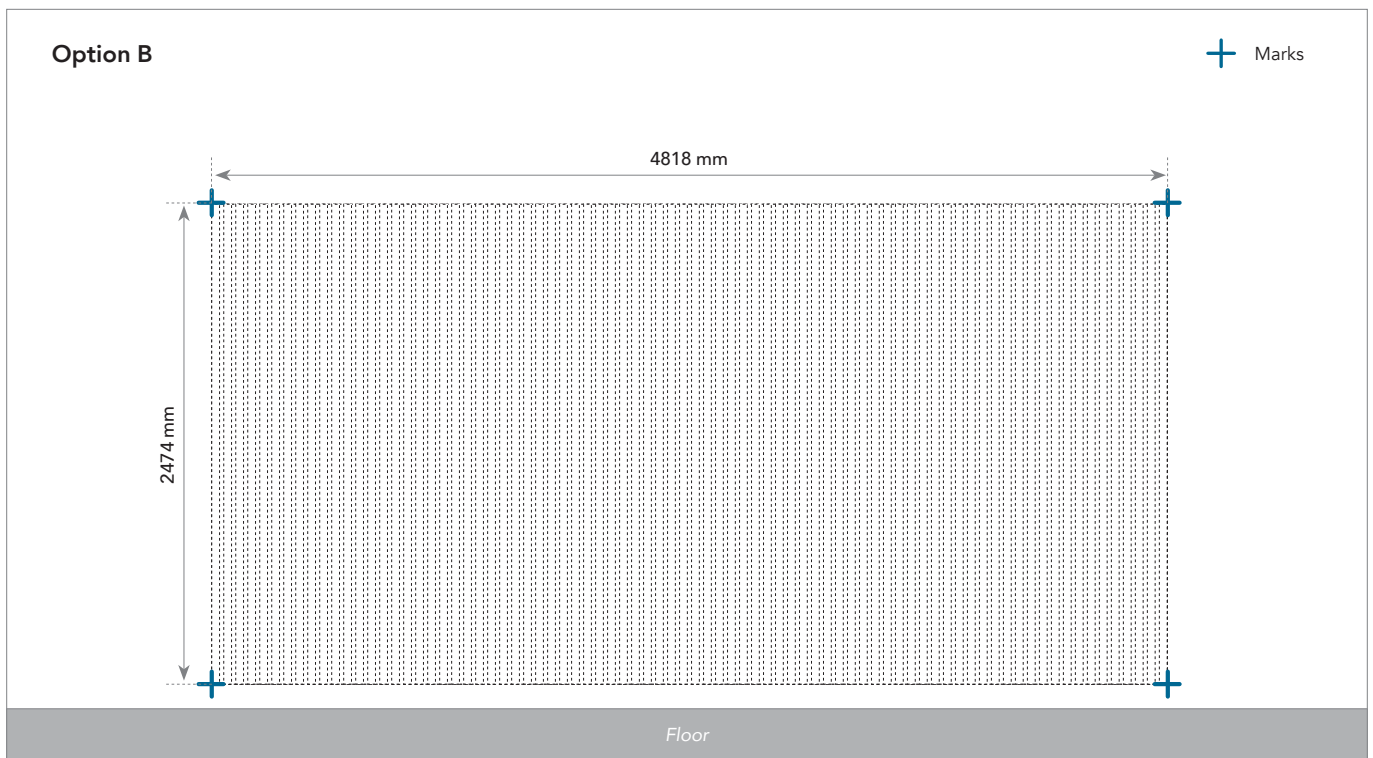

The maximum width of Rockfon Lamella is unlimited, thanks to the use of our specially designed Horizontal Profile Connector Brackets. This example shows a width of 4818 mm.

2 Set up laser. Profiles are aligned vertically with the laser.

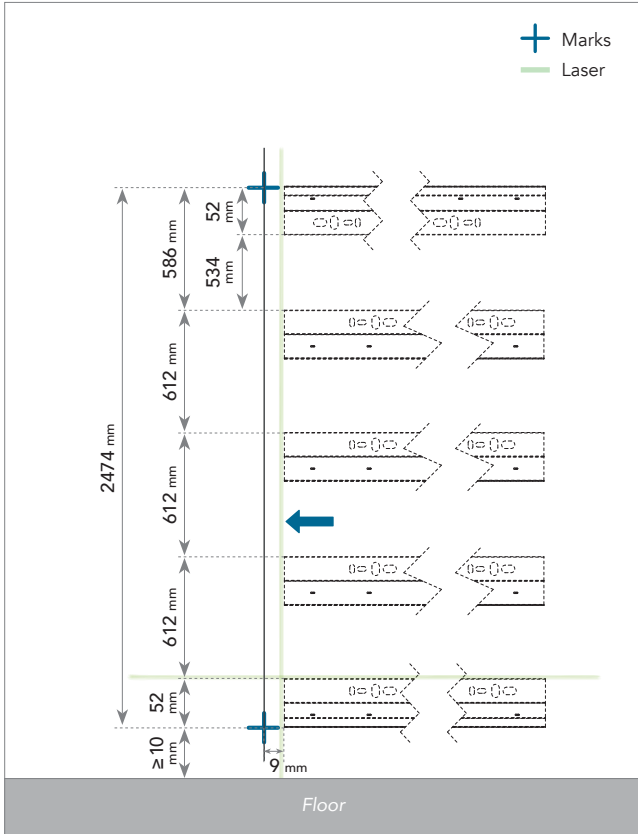

3 Mount the first 4 rails starting from the bottom.

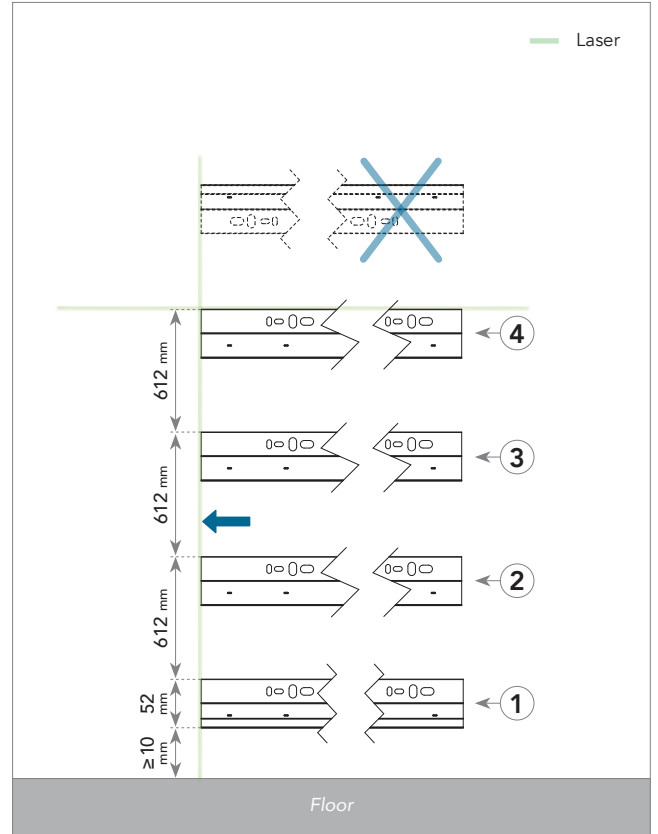

1 = Horizontal Profile - Top/Bottom.
 2, 3, 4 = Horizontal Profile - Middle.
 Fix the screws every 450 mm max.

ATTENTION



Pan head screws recommended.
 Not supplied by Rockfon.

ATTENTION



Fix the screws in the horizontal
 profiles every 450 mm max.

4 Mount the Rockfon Lamella Vertical End Profile - Left/Right to the Horizontal Profile - Top/Bottom.

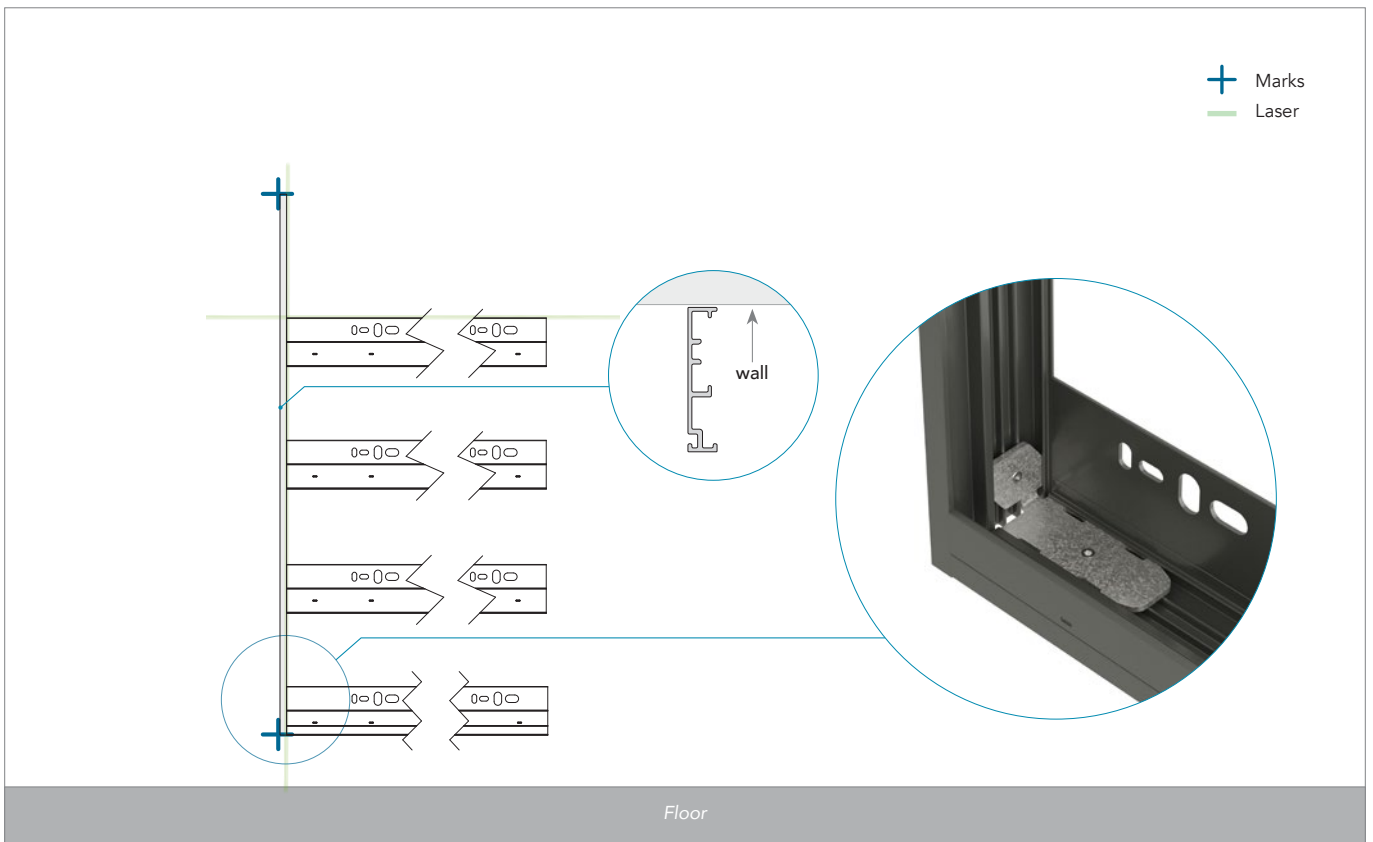

Mount the Vertical End Profile - Left/Right to the Horizontal Profile - Top/Bottom using the Vertical End Profile - End Connector Bracket and Vertical End Profile - Set Screw.

TIP



Mount the Rockfon Lamella Vertical End Profile - Set Screw into the bracket before mounting.

5 Mount the rest of the Rockfon Lamella Vertical End Profile - End Connector Bracket.

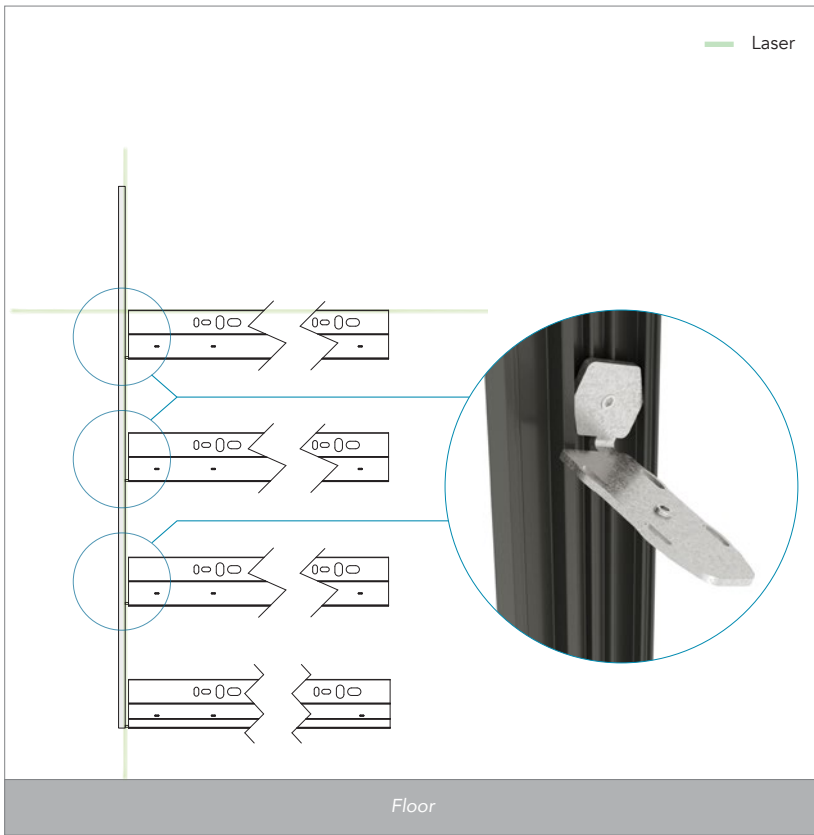

6 Mount the Rockfon Lamella Horizontal Profile - Top/Bottom.

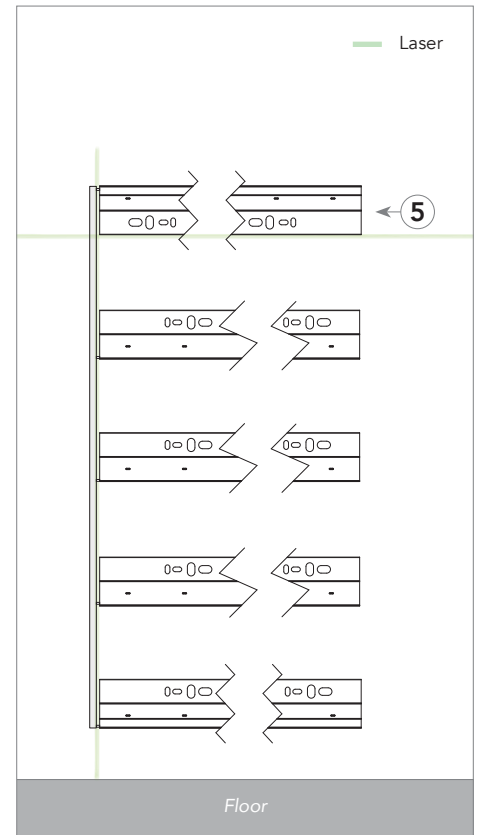

5 = Horizontal Profile - Top/Bottom.

TIP



The Vertical End Profile - End Connector Bracket can be twisted into the Vertical End Profile - Left/Right.

7 Push in Rockfon Lamella Horizontal Profile - Middle Connector Bracket
(only if the width of the lamella wall is >2418 mm - otherwise skip to step 9).

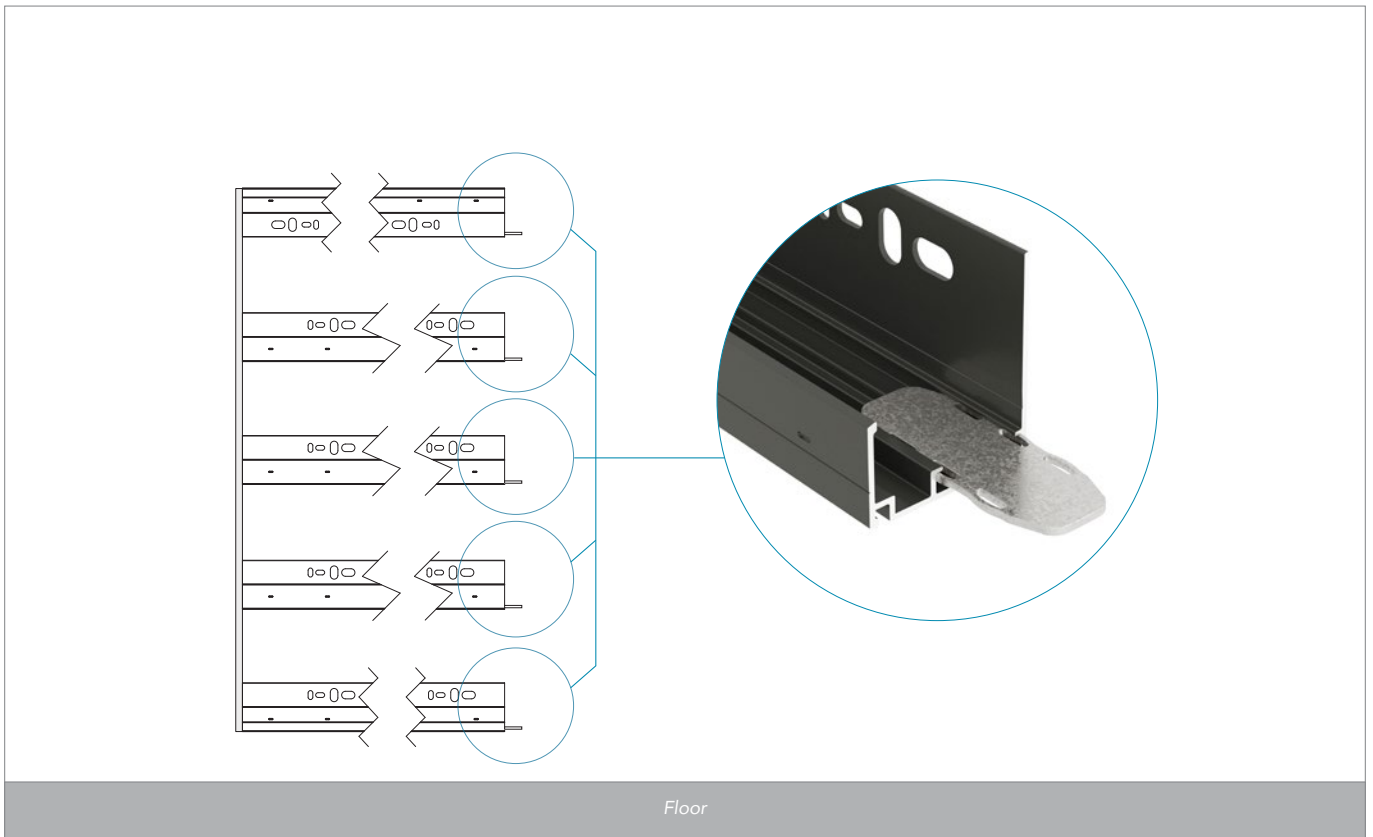

Push in Horizontal Profile - Middle Connector Bracket in all connecting ends of the mounted horizontal profiles.

TIP



Push the Horizontal Profile - Middle Connector Bracket in to approximately half length.

8 Mount extending profiles.

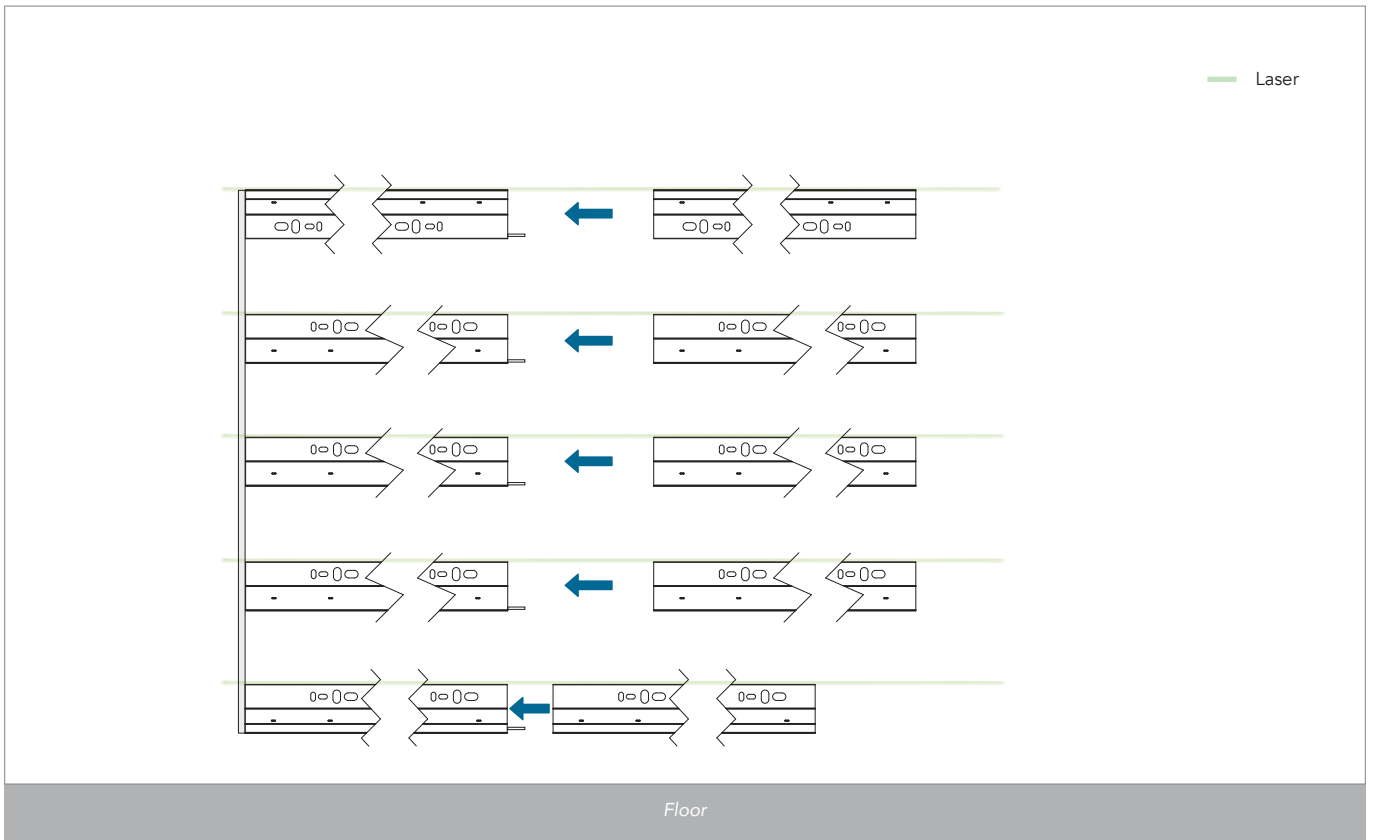

Set the laser to horizontally align the extending profiles. Connect them using the Horizontal Profile - Middle Connector Brackets to guide and align the profile ends and fix it to the wall.

9 Attach the Rockfon Lamella Vertical End Profile - Left/Right using the Vertical End Profile - End Connector Bracket.

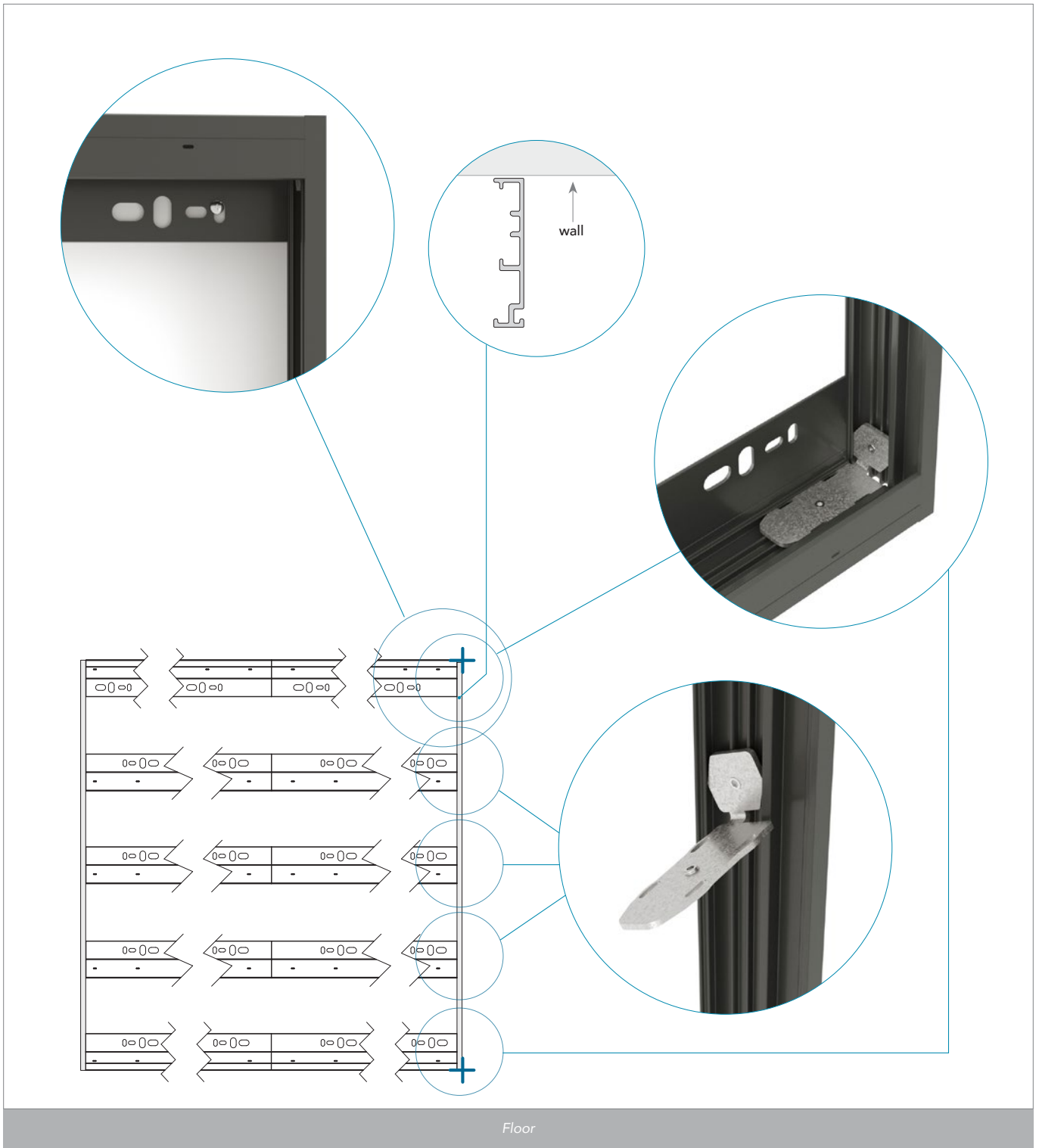

TIP



If necessary, loosen the last 1 or 2 screw(s) in the Horizontal Profile - Top/Bottom to adjust it to fit the top of the Vertical End Profile - Left/Right.

10 Place the Rockfon Lamella Bottom Spacers inside the base of the Horizontal Profile - Top/Bottom.

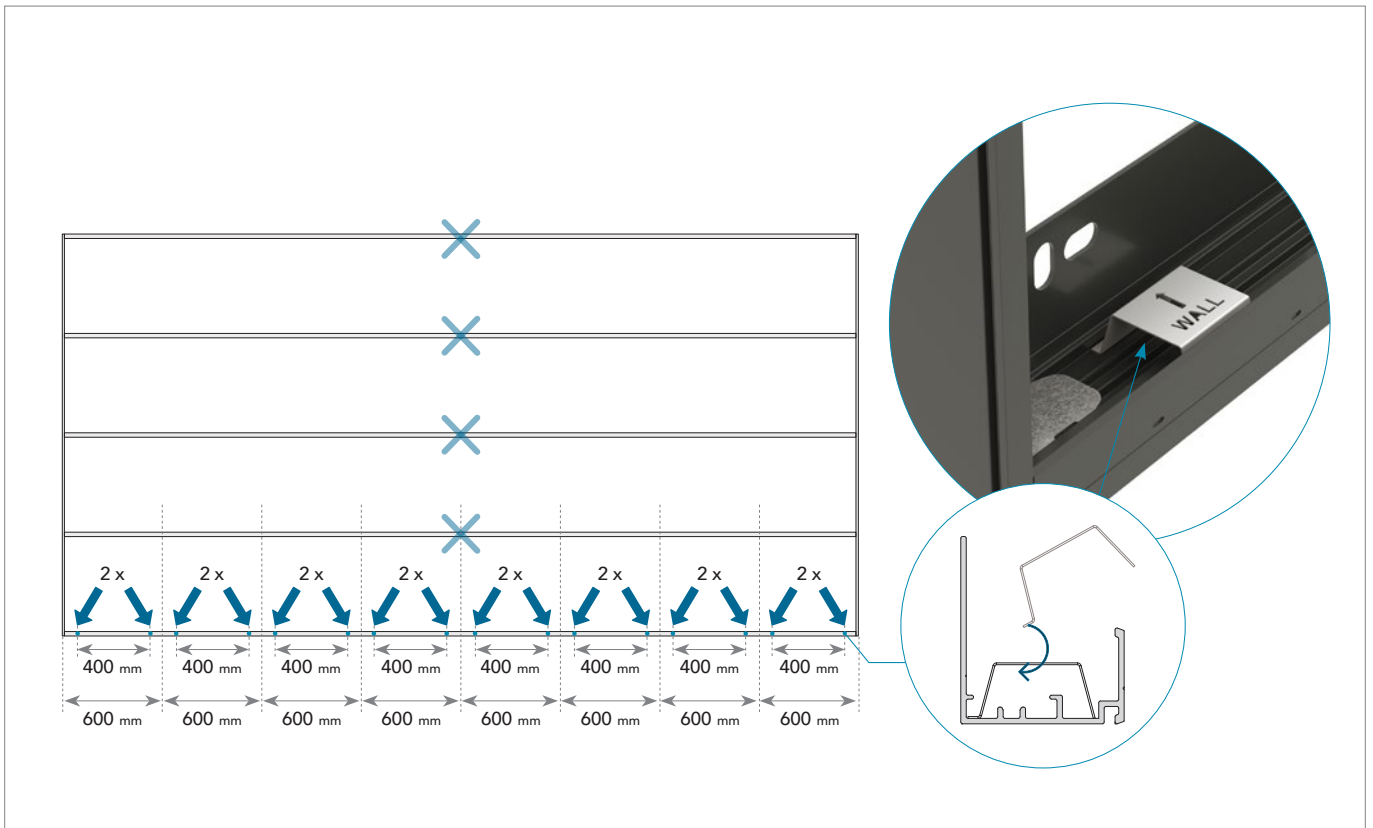

Use 2 Horizontal Profile - Bottom Spacers for every Sound Absorbing Panel Charcoal (2 pcs. per 600 mm)
 Distance between the Horizontal Profile - Bottom Spacers in each 600 mm section should be approximately 400 mm.

11 Insert Rockfon Lamella Sound Absorbing Panel Charcoal.



Push the Sound Absorbing Panel up into the profile above (a), push the bottom of the Sound Absorbing Panel in towards the wall (b), and let it drop down behind the front face of the profile below (c).



Slide all Sound Absorbing Panels Charcoal together.

TIP



Clean all profiles from dust or other dirt before mounting Sound Absorbing Panel Charcoal.

12 Use the Rockfon Lamella Guiding Ruler to align the Mounting Clip.



Take the Guiding Ruler and place it firmly against the Vertical End Profile - Left/Right. Attach the first Mounting Clip onto the Horizontal profile.

If starting with a 34 mm wide slat, please refer to illustration (a).
If starting with a 39 mm wide slat, please refer to illustration (b).
If starting with a 44 mm wide slat, please refer to illustration (c).

ATTENTION



Press in the alignment pin on the back of the Mounting clip - see step 13!

13 Push in the alignment pin on the back of the Rockfon Lamella Mounting Clip.

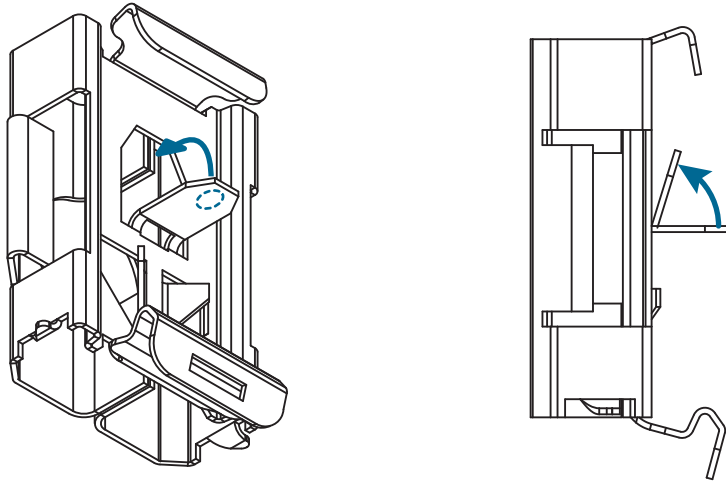

ATTENTION



Pressing in the alignment pin is only needed for step 12 + step 14!

TIP



Pressing the alignment pin inwards on the back of the Mounting Clip can easily be done with your thumb.

- 14 Mount the Rockfon Lamella Mounting Clips until aligned.

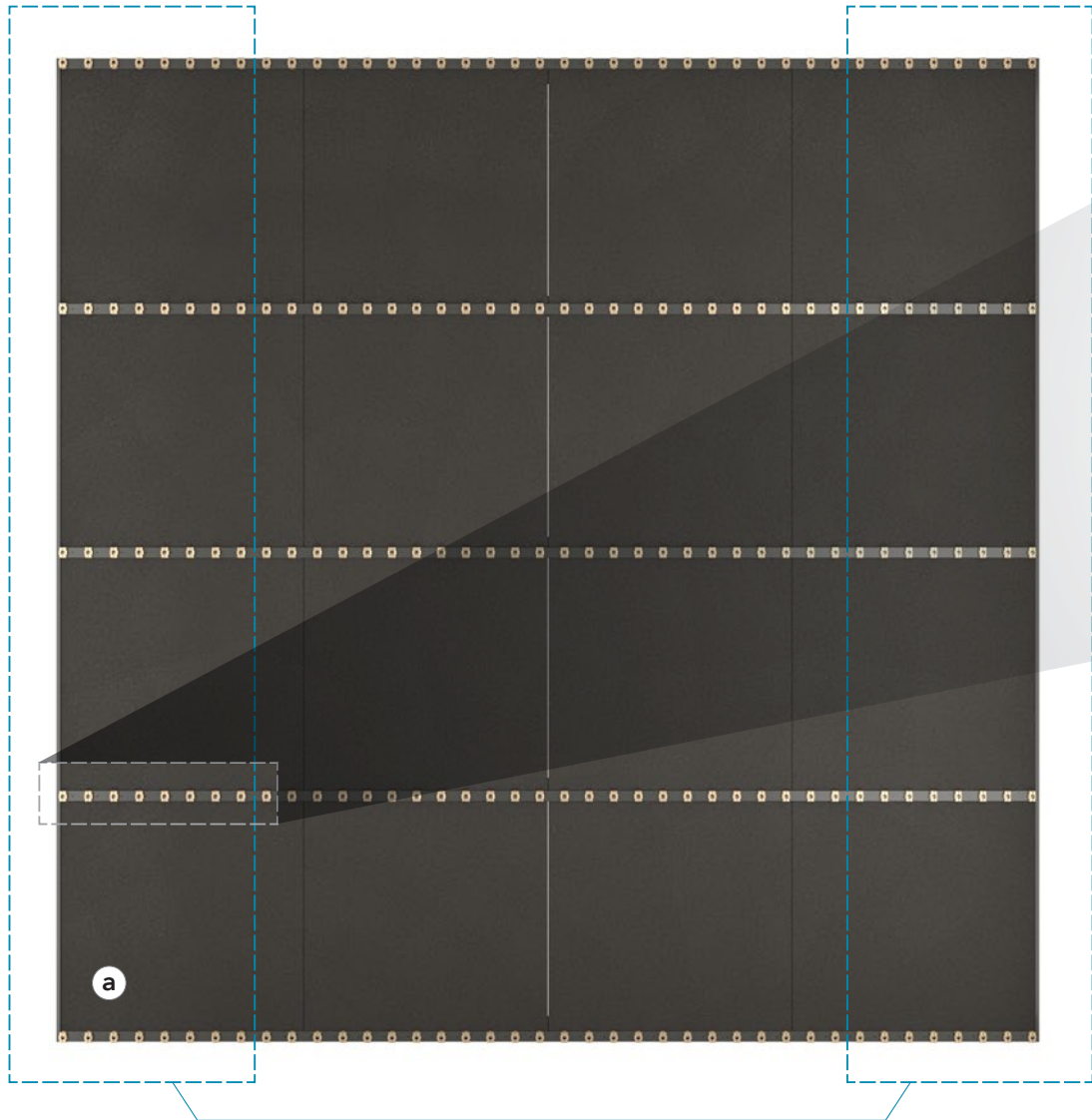

Area where Guiding Ruler is needed.

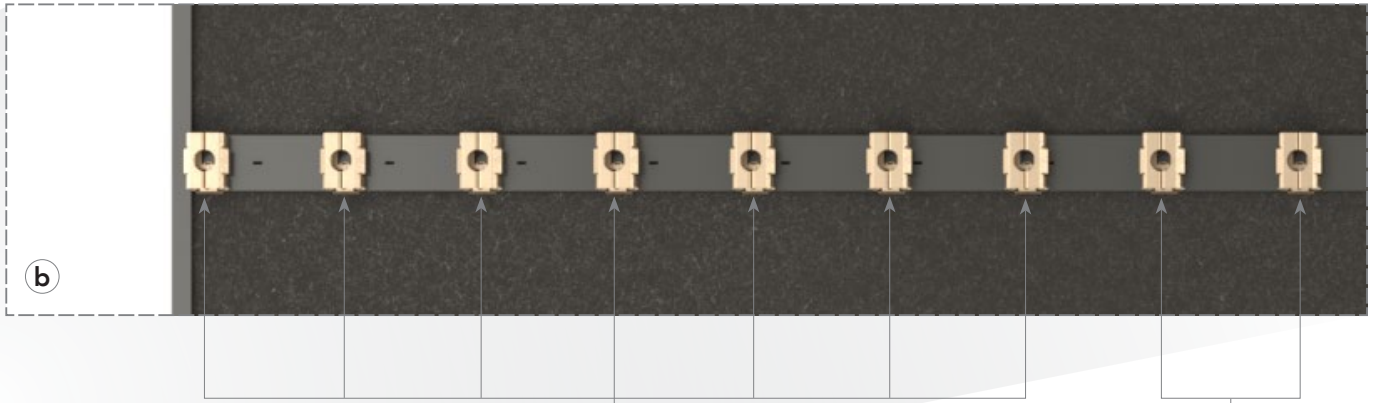

Offset – use the Guiding Ruler.



Aligned – use alignment hole/pin.

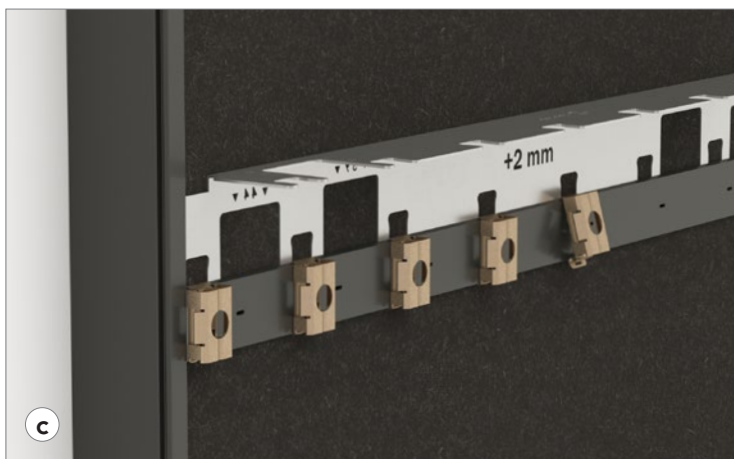

After the first Mounting Clip is correctly placed, place the Guiding Ruler (using the +2mm side) on the first Mounting Clip (c) and attach the subsequent Mounting Clips until the alignment hole on the horizontal mounting profile and the alignment hole (the cut-out) of the Guiding Ruler are aligned. Then move the Guiding Ruler to the opposing/finishing end (a) and repeat in the other direction.

If starting with a 34 mm wide slat, clip 12 is aligned.
 If starting with a 39 mm wide slat, clip 11 is aligned.
 If starting with a 44 mm wide slat, clip 10 is aligned.



Note that the alignment pin is pressed inwards and therefore free placement on the Horizontal Profile is possible.

15 Mount the rest of the Rockfon Lamella Mounting Clips using the alignment holes.

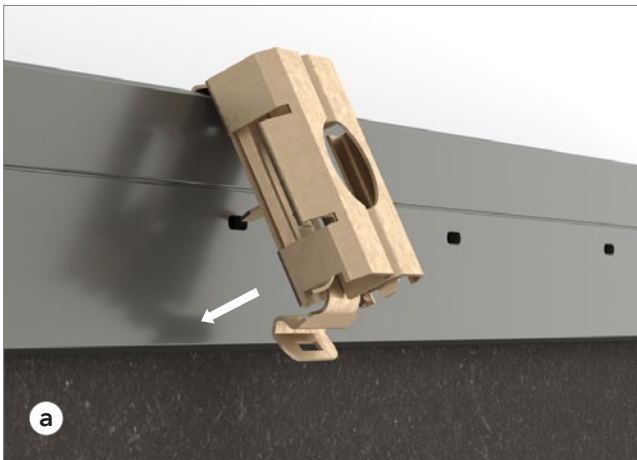

Attach the remaining Mounting Clips using the alignment holes. Hook the Rockfon Lamella Mounting Clips onto the horizontal profiles. Align the pin on the back of the Mounting Clip with the hole on the front face of the horizontal profiles.



Then push and click it on.

TIP



Turn the Mounting Clips 'upside down' in the horizontal bottom profile to have the hook pointing inwards (and not sticking out of the frame).

16 Mount the Rockfon Lamella Slat.



Mount the Lamella Slats by aligning them with the Horizontal Profile – Top/Bottom.



Press and punch the front face of each Lamella Slat, so they are fully attached to the Horizontal Profiles, via the Mounting Clips.

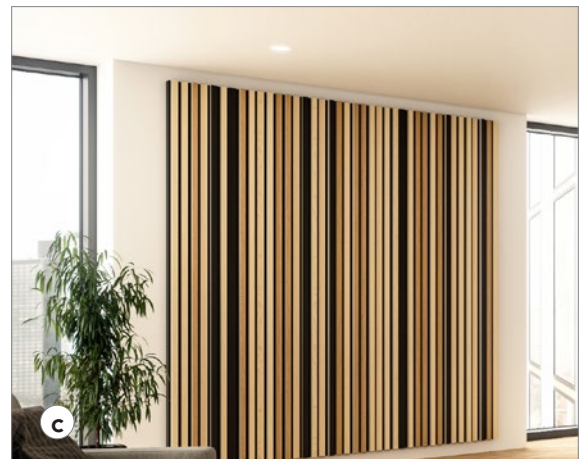

Final result, after mounting of all Lamella Slats.

ATTENTION



Don't use any hard or sharp tools that might damage the Slat.

TIP



Align the Lamella Slats with the Horizontal Profile – Top/Bottom using a wooden plank or the Guiding Ruler on top of the Horizontal Profile. Press the Lamella Slats against the plank or Guiding Ruler and attach them to the clip.

General installation recommendations

Panels

We recommend the use of clean nitrile or PU coated gloves when installing Rockfon panels in order to avoid finger prints and pollution of the surface.

For an optimum work environment, we recommend installers always observe common work practices and follow the installation advice as shown on our packaging.

Cutting is made easily with a sharp knife. All offcuts and holes must be treated according to local Building Regulations.

Note! Certain smooth matt surfaces are directional. To ensure consistency of the finished surface, it is important that all panels are installed in one direction, as indicated by the arrow printed on the back of each panel

Tools

Rockfon has developed specific tools that are available on www.rockfon.co.uk



Visit our online CAD Library or BIM portal to assist you in your project design.

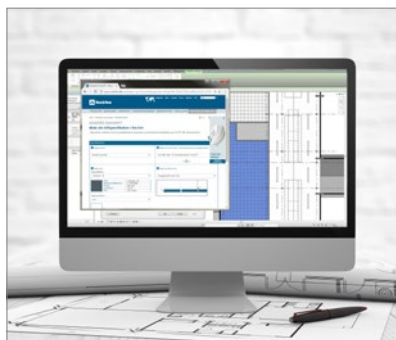

Generate specification texts for our products on our website.



Explore our vast library of reference projects on our website.

12.2022 | All colour codes mentioned are based on the NCS - Natural Colour System® property of and used on license from NCS Colour AB, Stockholm 2012 or the RAL colour standard. Subject to alterations in range and product technology without prior notice. Rockfon accepts no responsibility for printing errors.

Sounds Beautiful

