

Rockfon® System VertiQ® HAT A Wall™

System Description

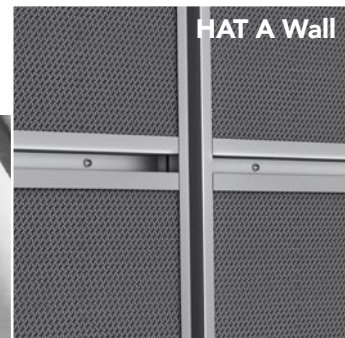

Visible profile wall system

- Wall panels with sound absorption properties
- Available in 4 standard colours
- An impact resistant wall system when combined with 1mm thick steel HAT and J profiles

Description

Rockfon System VertiQ HAT A Wall consists of 40 mm thick Rockfon® VertiQ® A HAT wall panels, installed using J-channel and 40 mm deep HAT profiles that are fastened horizontally and vertically to the wall substrate. A variety of HAT and J profiles are available.

The Rockfon VertiQ A HAT wall panels have a durable woven surface and are available in 4 colours (white, grey, light grey and black). Installed in Rockfon System VertiQ HAT A Wall the wall panels are not demountable.

For a “high impact-resistant” solution, Rockfon System VertiQ HAT A Wall must be mounted directly onto the wall, leaving no gap behind them and using 1 mm thick steel HAT and J profiles.

Restrictions

Rockfon System VertiQ HAT A Wall has been tested for impact resistance in accordance with DIN 18032 part 3 and fulfils the demands for handball ball throwing (restrictedly safe against ball throwing).

Rockfon System VertiQ HAT A Wall provides additional protection to the Rockfon VertiQ A HAT wall panels, by using HAT steel profiles that can be placed in areas subjected to occasional impact.

The impact resistance of Rockfon System VertiQ HAT A Wall is high. Nevertheless, it is not recommended for use in areas subjected to continuously high levels of impact. Rockfon System VertiQ HAT A Wall is not recommended in swimming pools due to the risk of corrosion.

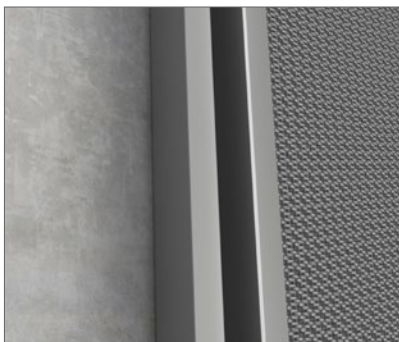
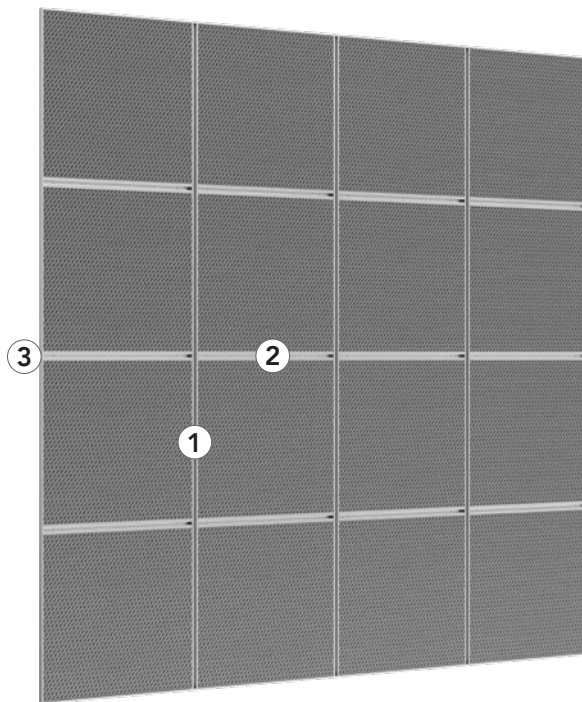

HAT profiles are fastened directly to the wall.



40 mm J-channel (25/40/13 mm) and the supporting bracket are used to support the bottom of the wall panels when mounted at multiple-heights or off the floor. When using the 1 mm thick J-channel, supporting brackets are not needed.

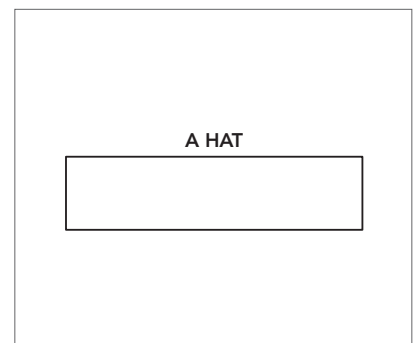

A HAT-edge.

System components and installation guide

The quantities required of the different components depend on the size of the wall panel. Here is an example for a solution of 4 Rockfon VertiQ A HAT wall panels in width and 4 wall panels in height:

Panel		HAT A Profile + J-channel		
		1	2	3
-		HAT-Intermediate Profile L = 2700 mm	HAT-Profile L = 1148 mm	J-channel, 1 mm L = 2700 mm
Panel layout*	Dimension (mm)	Consumption/m ²		
4 x 4	1200 x 600	16 pcs	14.4 lm	7.2 lm
4 x 4	1200 x 1200	16 pcs	14.4 lm	14.4 lm
2 x 4	1800 x 600	12 pcs	10.8 lm	2.4 lm
1 x 4	2400 x 600	4 pcs	7.2 lm	-
1 x 4	2700 x 1200	4 pcs	8.1 lm	-

Installation of Rockfon VertiQ wall panels should only be carried out using components supplied by Rockfon. Components are sold separately.

Failure to follow these instructions will void any warranty.

* Panel height is always positioned vertically.

Wall panel - A HAT-edge

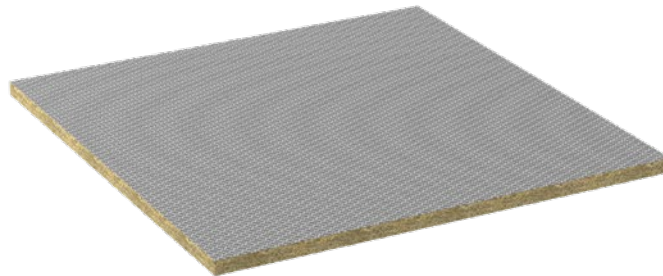

HAT Profile + J-channel

1. HAT Intermediate Profile 2700 mm



2. HAT Profile 1148 mm



5. J-channel



Performance



Impact resistance

Rockfon System VertiQ HAT A Wall has been tested for impact resistance in accordance with DIN 18032 part 3 and fulfils the demands for handball ball throwing (restrictedly safe against ball throwing).



Corrosion resistance

Class B (EN13964)



Demountability

Wall panels mounted in Rockfon System VertiQ HAT A Wall are not demountable.

Compatible Wall panels Overview

All Rockfon A-edge wall panels available in dimensions mentioned below can be installed in Rockfon System VertiQ HAT A Wall.





		Dimensions (mm)				
Wall panels	Thickness (mm)	1200 x 600	1200 x 1200	1800 x 600	2400 x 600	2700 x 1200
Rockfon® VertiQ®	40		•			•

Grid Installation

Grid layout and hanger location

Installation diagrams.

Wall panel dimensions = M (module) - 28 mm (e.g. 2700 mm - 28 mm = 2672 mm).

-  Rockfon VertiQ panel
-  J-channel perimeter trim
-  HAT profile
-  Supporting bracket
-  SMF clip

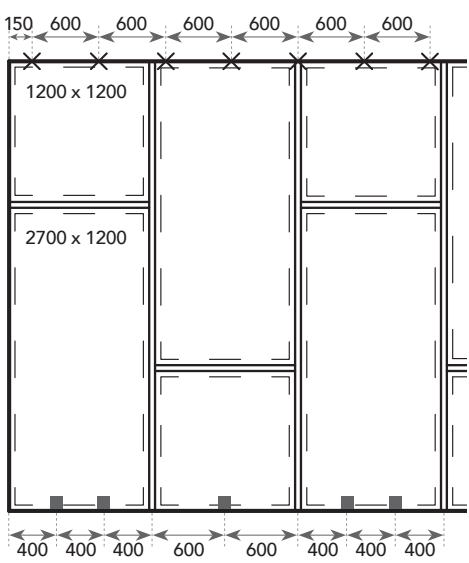
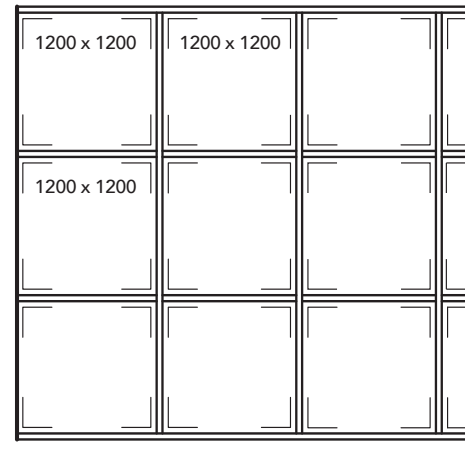
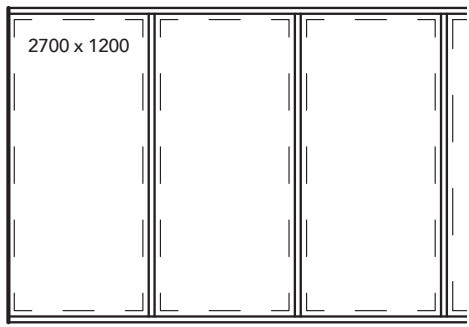
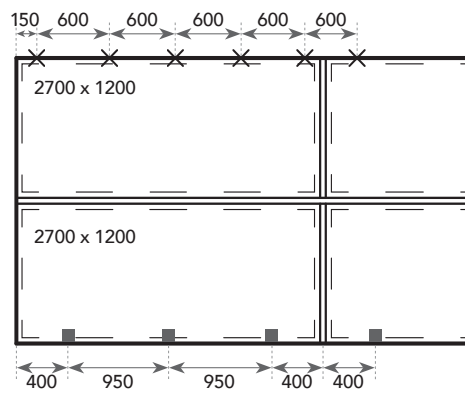
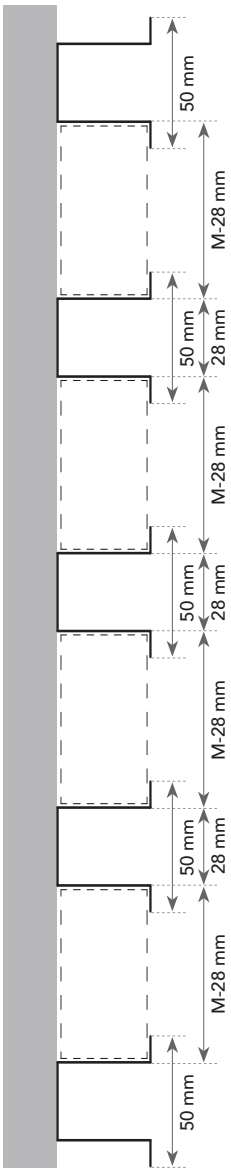
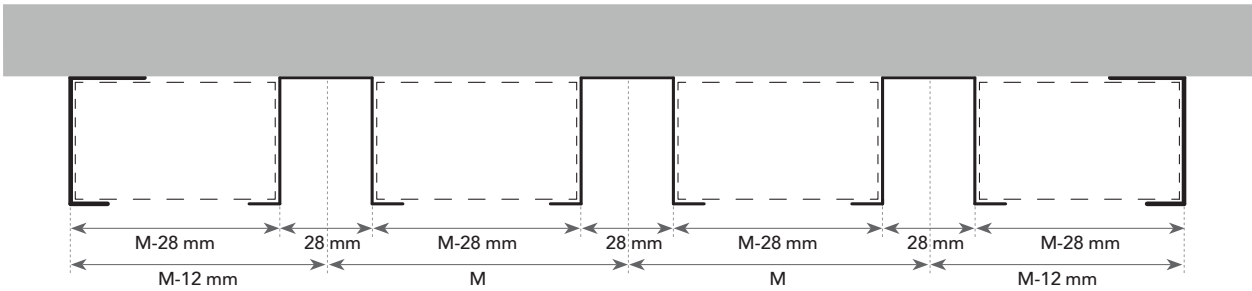

Minimum installation depth (mm)

Wall panels installed in Rockfon System VertiQ HAT A Wall are not demountable.

Panel thickness	Module size	D
mm		
40	1200 x 600	40
	1200 x 1200	
	1800 x 600	
	2400 x 600	
	1200 x 1200	

The installation depth is defined as the distance from the front side of the wall panel to the wall substrate. D represents the exact installation depth that allows for easy wall panel installation.

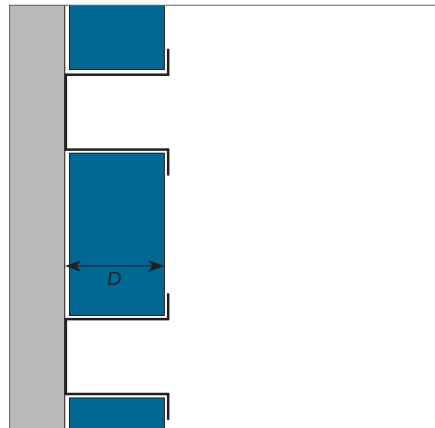

Installation requirements

Use mounting screws/methods appropriate for the wall material. Ensure that the wall is smooth and level. Any levelling corrections must be carried out before installation begins.

1. Perimeter trim



1.1 Mark out all the axes for perimeter trims and intermediate profiles.

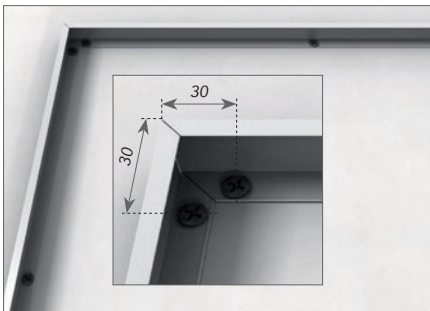

1.2 The perimeter trim should be positioned with the 25 mm wide edge facing the wall.

Important

- Use mounting screws/methods appropriate for the wall material.
- Use a sharp-bladed saw to carefully achieve neat corner joints.
- Placing an internal support, e.g. a 40 mm thick wood board, inside the perimeter trim to reduce bending/damaging when cutting.

For off-floor installations, consideration should be given to using a scuff-resistant skirting or baseboard between the floor and bottom perimeter trim. This will reduce the likelihood of damage caused from shoes, luggage, vacuum cleaners or other floor-level risks. It will also help avoid ball or human contact with any low-lying perimeter trim corners.

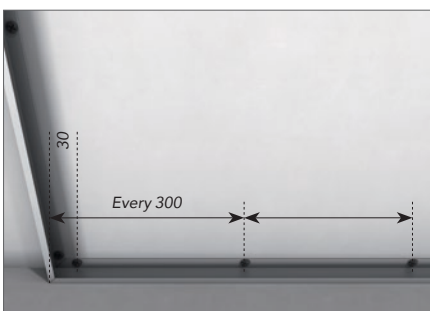

1.3 Bottom perimeter trim resting on the floor or other solid base support material.

2. Wall panels and horizontal intermediate profiles

These instructions cover both single and multiple-height installations. For multiple-height installations, the terms 'upper' and 'lower' refer respectively to the uppermost and lowermost wall panels.



2.1 Start installing Rockfon VertiQ wall panels working inward from the outside/perimeter wall panels. Install both left and right, bottom wall panels first. Ensure that all outside/perimeter wall panel edges are securely tucked under their perimeter trims.



2.2 For multiple-height installations, place the next wall panel above and cover the horizontal joint(s) between the wall panels with a 50 mm HAT profile, at the exact length of M-52 mm (see diagram on page 9), fixed at wall panel's centre (figure 2.4). Ensure that the wall panel's edges are covered by perimeter trims (J or HAT) and intermediate HAT profiles.



2.3 All outside/perimeter wall panels installed with horizontal HAT profiles.



2.4 Install all the remaining wall panels and horizontal HAT profiles, working toward the middle.

2.5 Cover all the horizontal joints with HAT profiles centred on the wall panel's width, leaving a 52 mm gap between them for the vertical HAT profile.

3. Vertical intermediate profiles

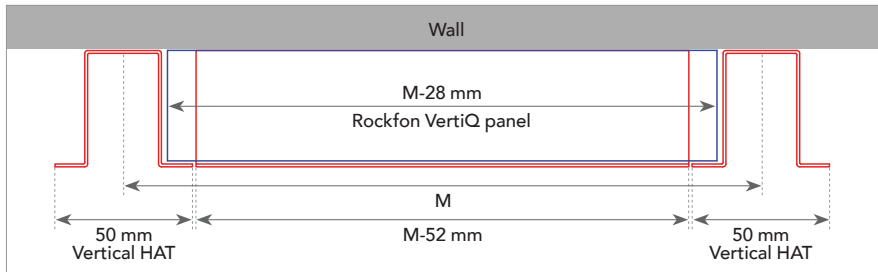

M = Module.



3.1 All Rockfon VertiQ wall panels and HAT profiles installed.

3.2 The vertical HAT profile edges should meet cleanly against the horizontal HAT profile edges, not overlap them.

General installation recommendations

Wall panels

We recommend the use of clean nitrile or PU coated gloves when mounting Rockfon® wall panels in order to avoid finger prints and pollution of the surface.

For an optimum work environment, we recommend installers always observe common work practices and follow the installation advice as shown on our packaging.

Cutting is made easily with a sharp knife. All offcuts and holes must be treated according to local Building Regulations.

Note! Certain smooth matt surfaces are directional. To ensure consistency of the finished surface, it is important that all wall panels are installed in one direction, as indicated by the arrow printed on the back of each wall panels.

Tools

Rockfon has developed specific tools that are available on www.rockfon.co.uk



Visit our online CAD Library or BIM portal to assist you in your project design.

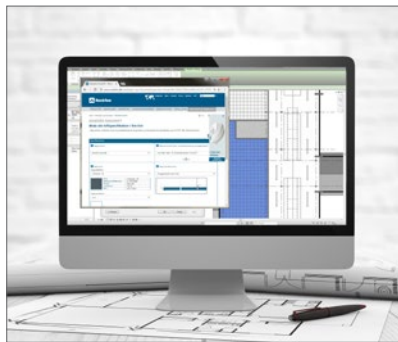

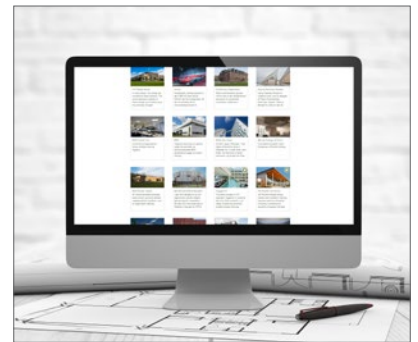

Generate specification texts for our products on our website.



Explore our vast library of reference projects on our website.

Rockfon® is a registered trademark
of the ROCKWOOL Group.

 twitter.com/RockfonUK

 linkedin.com/company/Rockfon-uk/

 instagram.com/Rockfon_official/

 youtube.com/RockfonUK

04:2019 | All colour codes mentioned are based on the NCS - Natural Colour System™ property of and used on license from NCS Colour AB, Stockholm 2012 or the RAL colour standard. Subject to alterations in range and product technology without prior notice. Rockfon accepts no responsibility for printing errors.



Rockfon
ROCKWOOL Limited T/A Rockfon
14th Floor, Chiswick Tower, 389 Chiswick High Road,
London W4 4AL
Tel: +44 (0) 208 222 7457
www.rockfon.co.uk