

Rockfon® System VertiQ® C Wall™

System Description



Concealed wall system

- Wall panels with sound absorption and impact resistance properties
- Available in 4 standard colours
- Specially developed system making installation quick and easy
- Every panel is demountable

Description

Rockfon System VertiQ C Wall consists of 40 mm thick Rockfon® VertiQ® C Wall panels. It is installed using specially designed fixing brackets, anodised aluminium perimeter cover profiles and rounded corner connectors for increased safety.

Rockfon VertiQ C Wall panels have an elegant and durable woven surface, available in 4 colours (white, grey, light grey and black) which are easily demountable.

Restrictions

Rockfon System VertiQ C Wall has been tested for impact resistance in accordance with DIN 18032 part 3 and fulfils the demands for handball ball throwing (restrictedly safe against ball throwing).

The impact resistance of the panels is high, however, it is not recommended for use in areas which are subjected to continuous high levels of impact.

The woven surface of Rockfon VertiQ provides enhanced resistance to perforation.

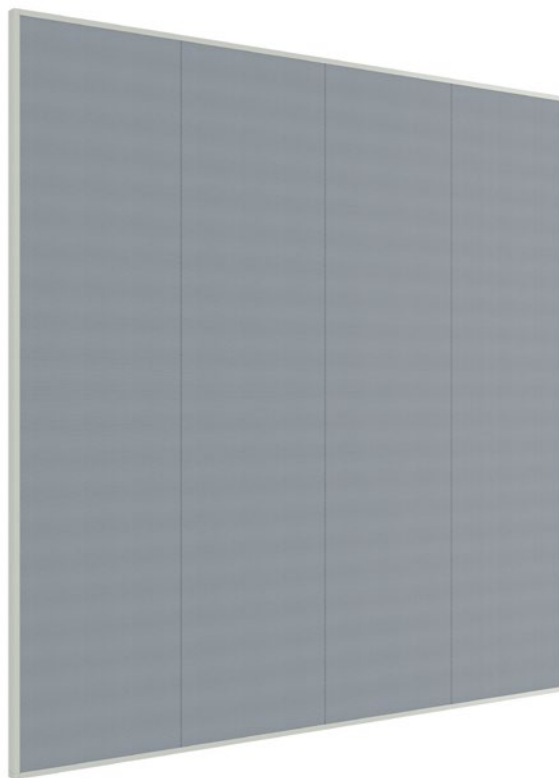

Elegant and safe rounded corner details in aluminium.



Nice and neat concealed connection between the panels and anodised aluminium perimeter cover profile.

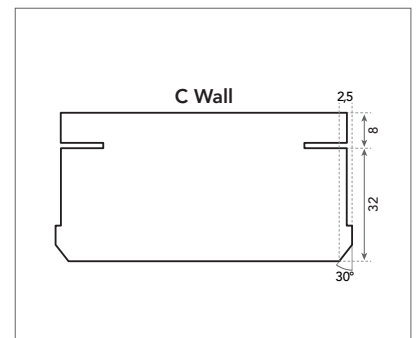

C-edge.

System components and installation guide

The quantities required of the different components depend on the size of the surface area.

Here is an example with 4 Rockfon VertiQ C Wall panels in width and 1 panel in height (2400 x 600):

Tile		Cover profiles + Accessories					
		1	2	3	4	5	6
-		Perimeter cover profile L = 2380 mm	Fixing bracket	External corner connector	Internal corner connector	Connection plate	Locking screw
Dimension (mm)	Consumption/m ²						
2400 x 600	4 pcs/m ²	9.60 lm/m ²	20 pcs	4 pcs/m ²	-	6 pcs	8 pcs

Panel – C-edge

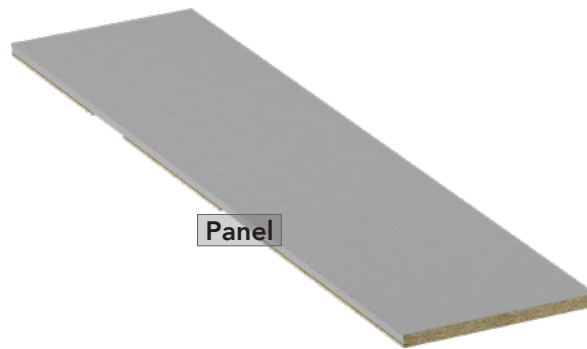

Cover profiles + Accessories

1 Perimeter cover profile



2 Fixing bracket



3 External corner connector



4 Internal corner connector



5 Connection plate



6 Locking screw



Performance



Corrosion resistance

Class B (EN13964)



Demountability

Panels installed in Rockfon System VertiQ C Wall are fully demountable, using a demounting tool.



Impact resistance

Rockfon System VertiQ C Wall has been tested for impact resistance in accordance with DIN 18032 part 3 and fulfils the demands for handball ball throwing (restrictedly safe against ball throwing). The impact resistance of Rockfon VertiQ is high, however, it is not recommended for use in areas which are subjected to continuous high levels of impact.

Compatible Panels Overview

Only Rockfon VertiQ Wall panels available in dimensions mentioned below can be installed in Rockfon System VertiQ C Wall.

		Dimension (mm)
Panels	Thickness (mm)	2400 x 600
Rockfon® VertiQ® C	40	•

Please contact Rockfon for other dimensions.

Installation

Layout

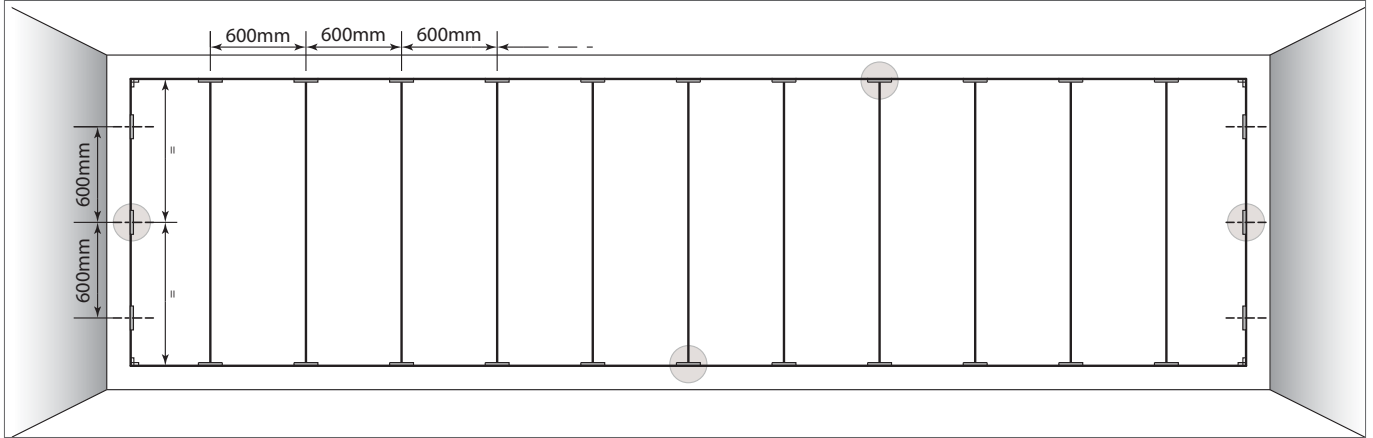

Measure the surface of the installation. It needs to be horizontally divisible by 600 mm. Other end panel widths can be used but not cut less than 300 mm.

Installation requirements

Ensure that the walls are smooth and even. For installation "directly on the floor", ensure that the floor is horizontal and flat. Carry out any smoothing/levelling work before installation of the system. If necessary, install a framework to compensate for uneven walls. The walls upon which the wall panels are to be installed must be clean and dry.

For off-floor installations, consideration should be given to using a scuff-resistant skirting or base support between the floor and bottom perimeter trim. This will reduce the likelihood of damage from shoes, luggage, vacuum cleaners or other floor-level risks.

Use mounting screws, methods and amount of fixing points appropriate for the wall material.

Check the rectangular mounting surface, the diagonals must be the same length:

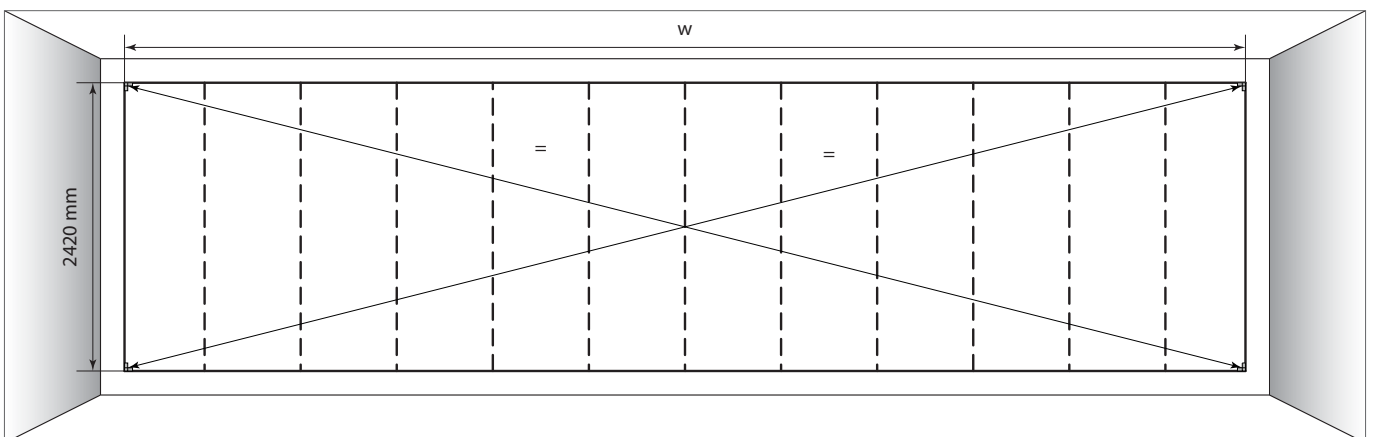

Installation steps

1 Setting out.

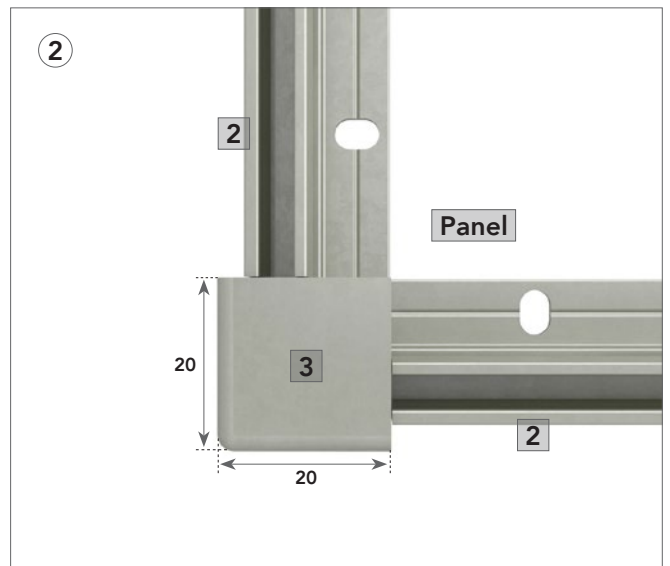
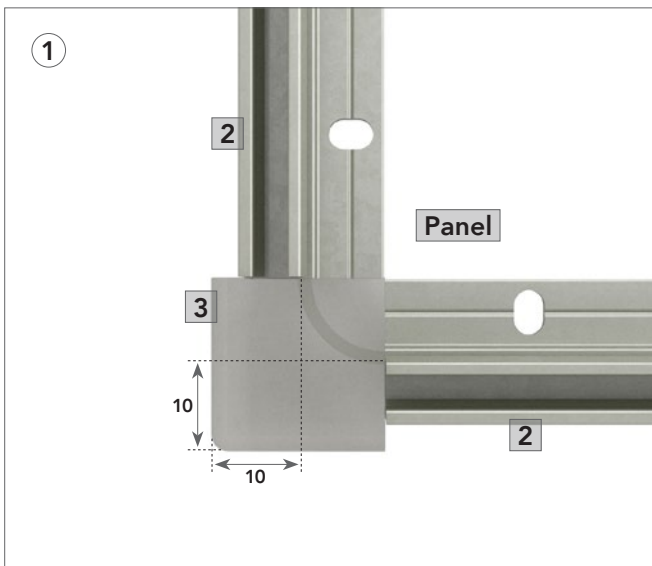
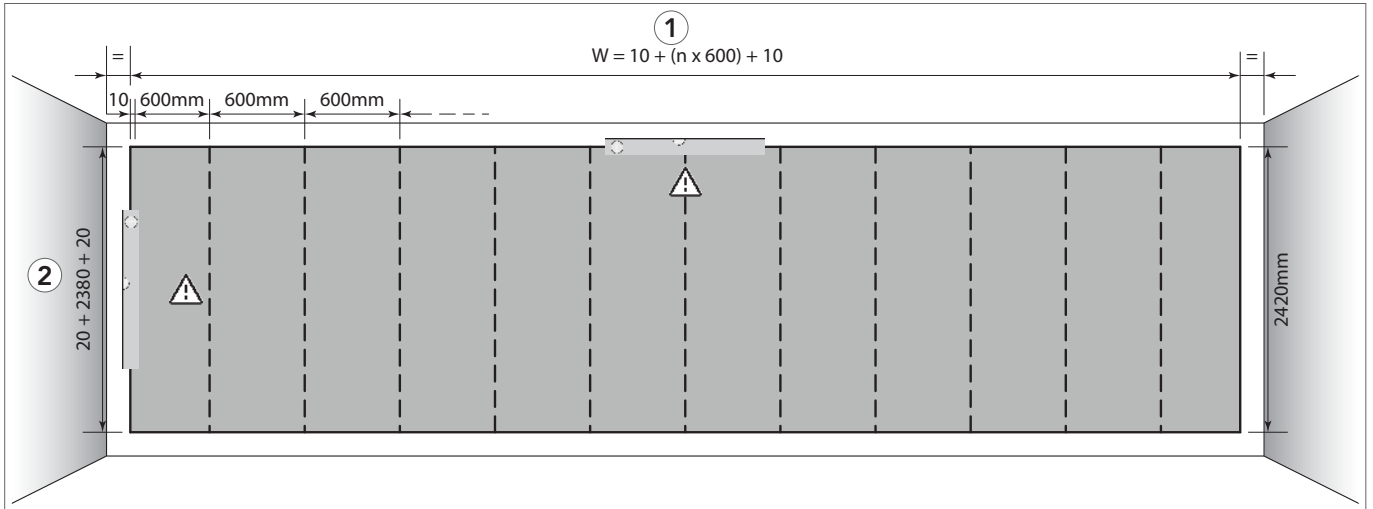

2 Assemble and install external corner connectors and two fixing brackets in each corner.

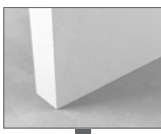
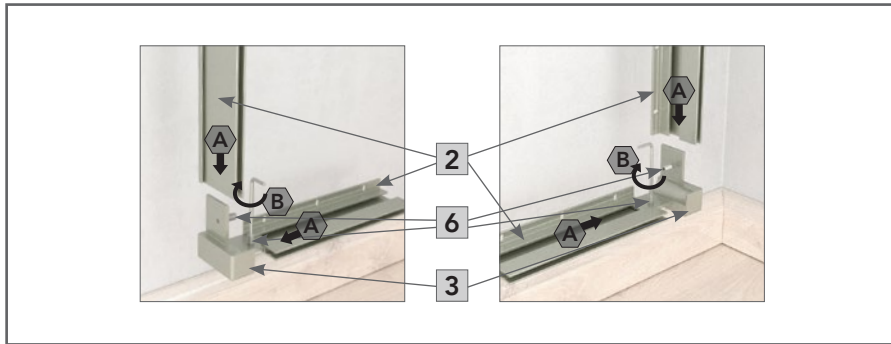
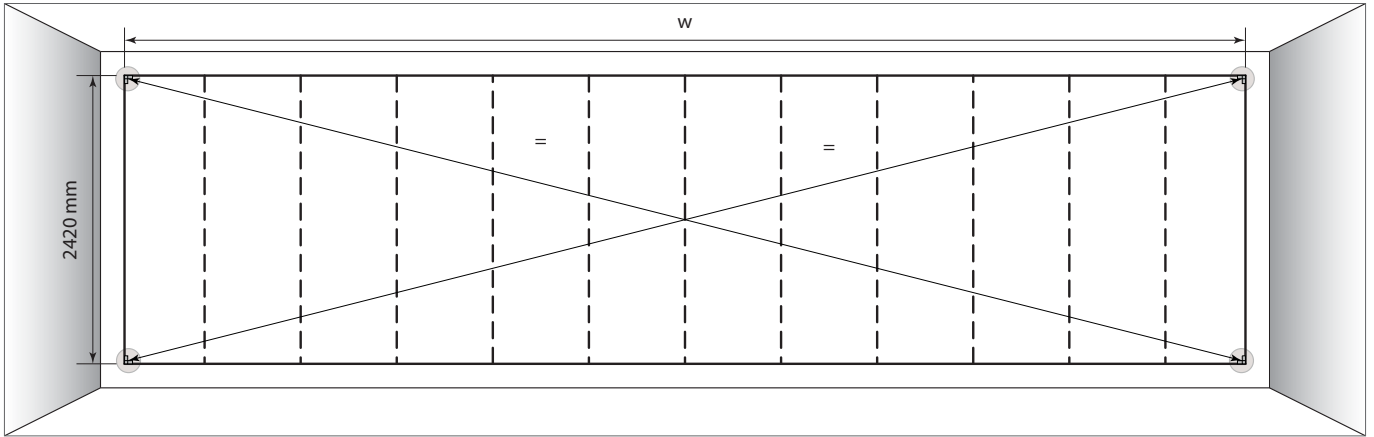

Note! Check the rectangular mounting surface: the diagonals must be the same length.

Note! Use the relevant methods, mounting screws and number of fixing points appropriate for the wall material.

3 Check the components and install all remaining fixing brackets.

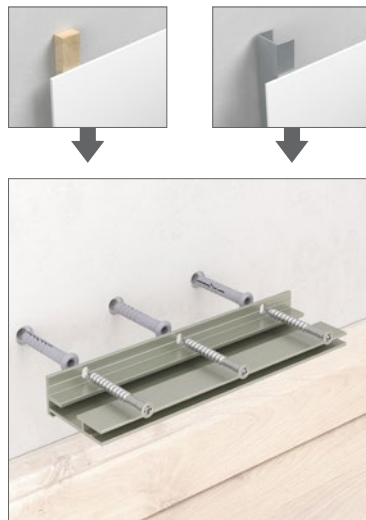
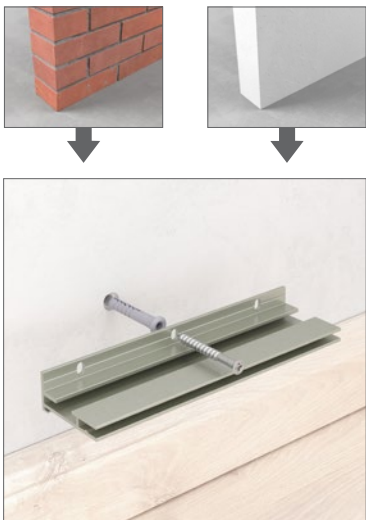
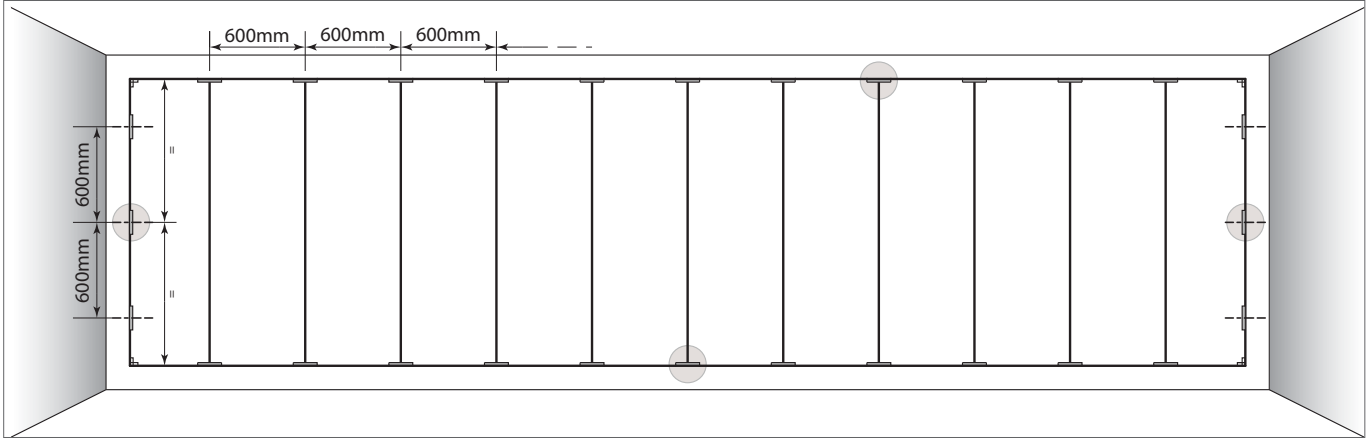

Note! Use the relevant methods, mounting screws and number of fixing points appropriate for the wall material.

4 Install all perimeter cover profiles into their fixing brackets and ensure alignment.

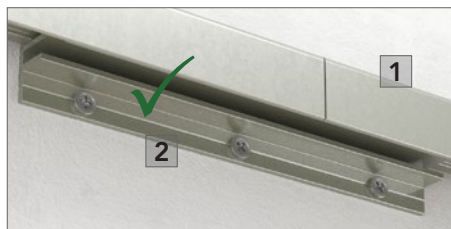
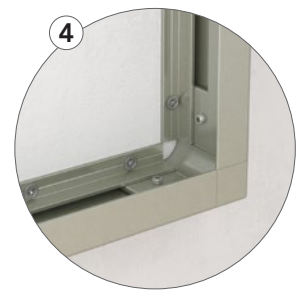
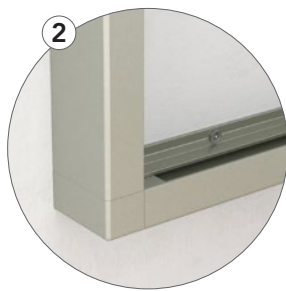
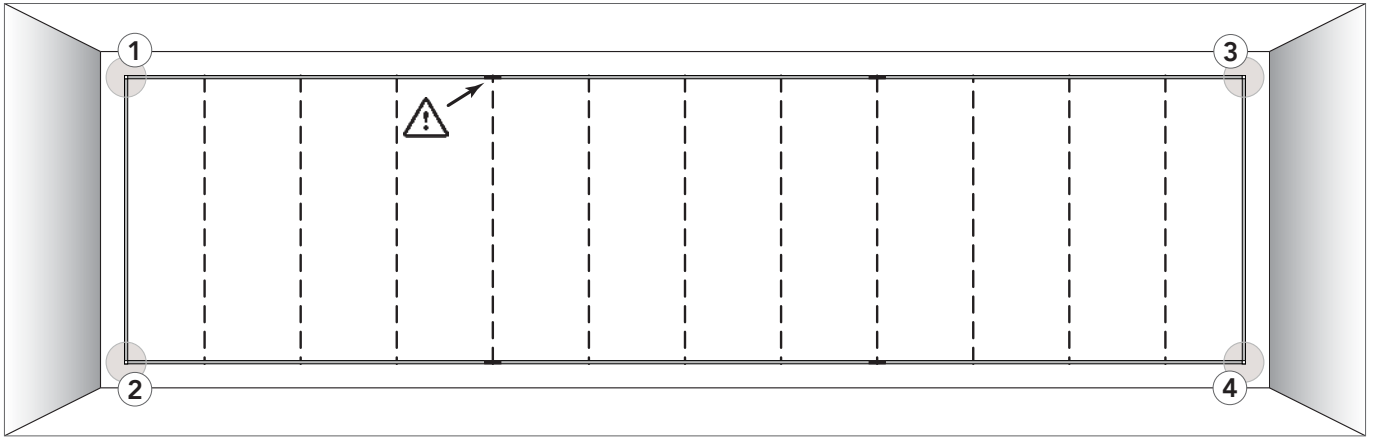

Note! Fix all the perimeter cover profiles into their fixing brackets to ensure that the grid is aligned.

Where necessary, adjust the grid accordingly. When in correct position, demount side and bottom cover profiles but not the top cover profiles - they remain fixed in their fixing brackets. The grid is now ready for mounting the wall panels.

 Always ensure there is a fixing bracket at the joint between adjoining perimeter cover profiles.

5 Install the first wall panel to the left.

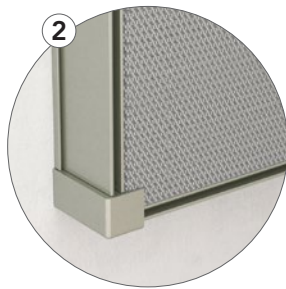
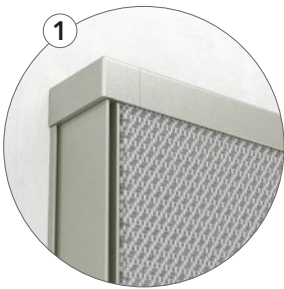
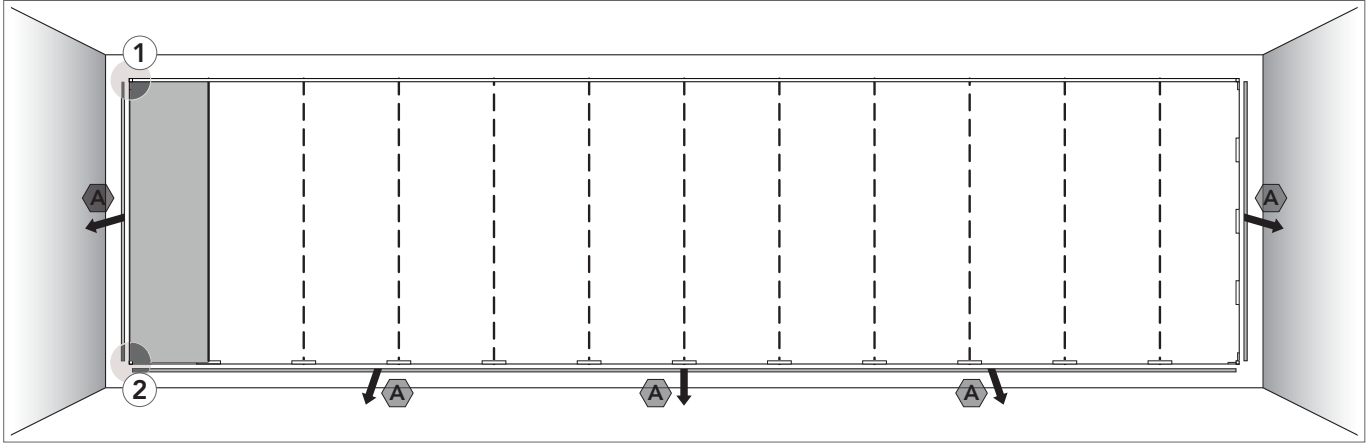

6 Install all the wall panels, except for the penultimate panel.

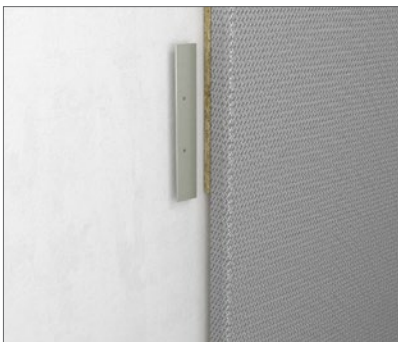
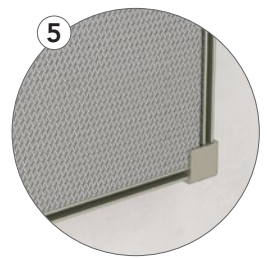
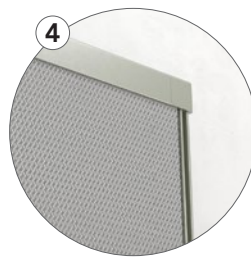
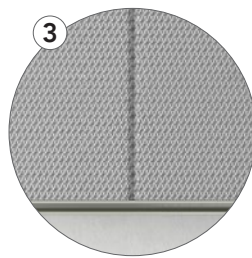
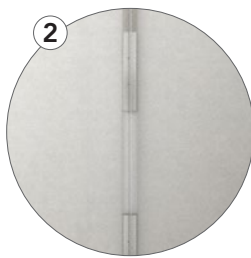
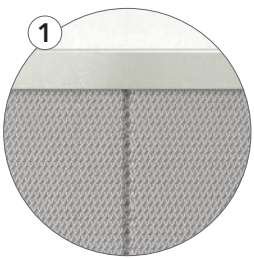
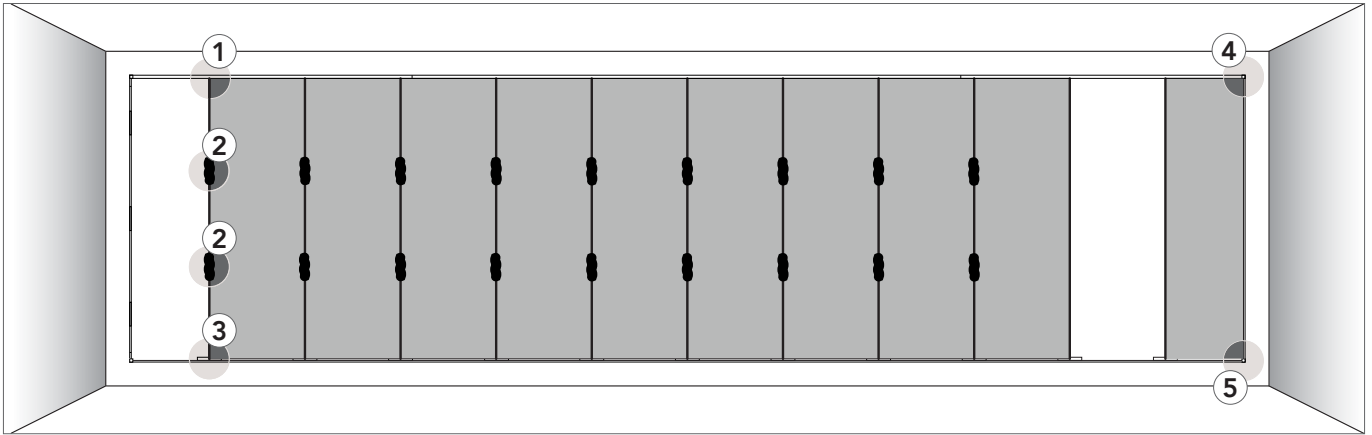

Note! To achieve a level and solid panel construction across the entire wall, connection plates should be used to lock adjoining panels together. Insert a connection plate into the groove just above the recess at the back edge of the panel. Use two connection plates per panel. This will allow you to demount every single panel independently.

7 Install the final panel on the wall.

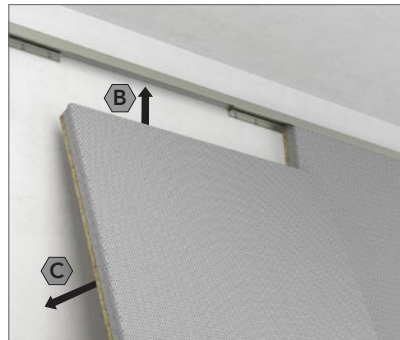
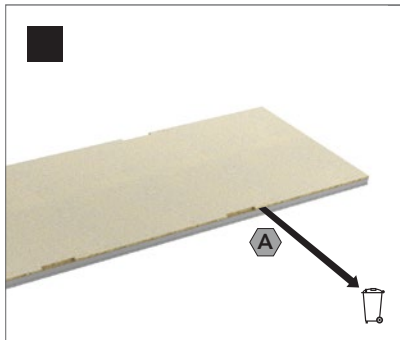
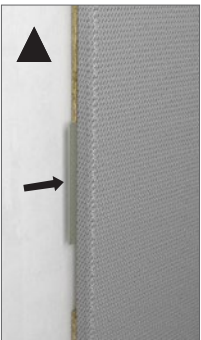
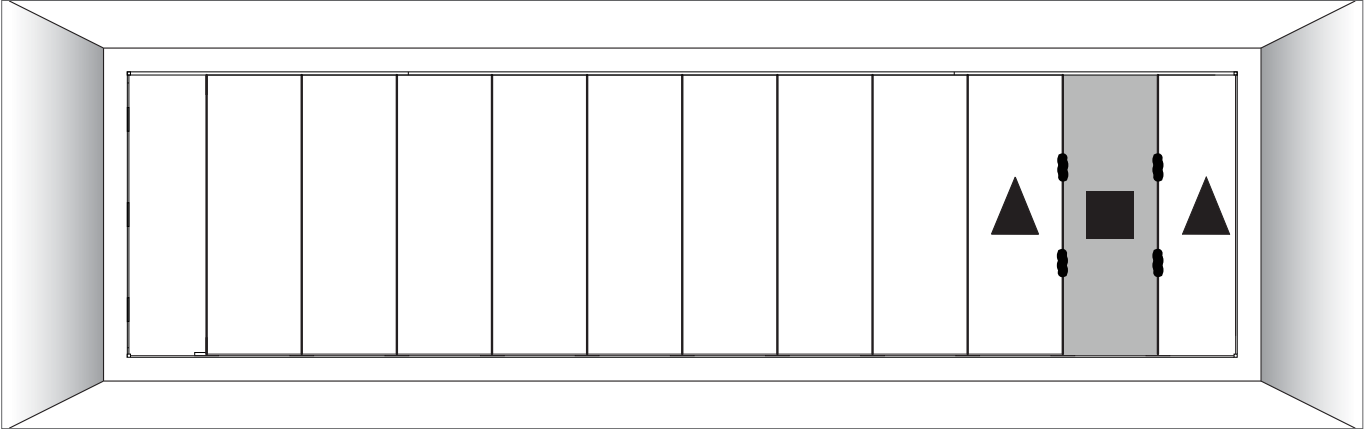

Note! At every recess (4 x), use a knife to cut out 50-60 mm more space on the top side of each recess from the reverse of the panel.

Note! At the end, use a knife (plaster knife) to lift up the 4 connection plates to achieve perfect locking.

8 Install all the perimeter cover profiles to the left, right and bottom.

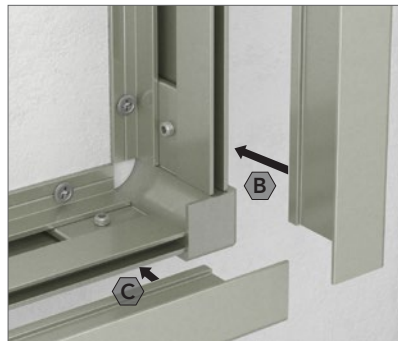
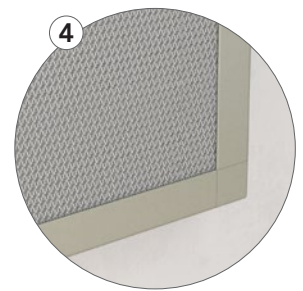
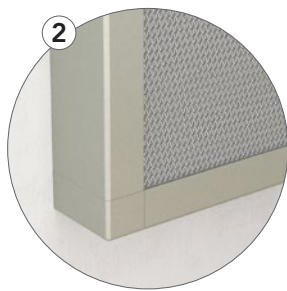
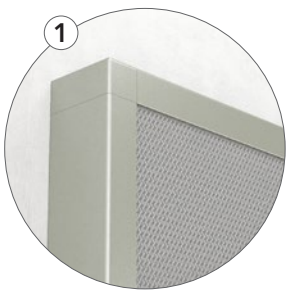
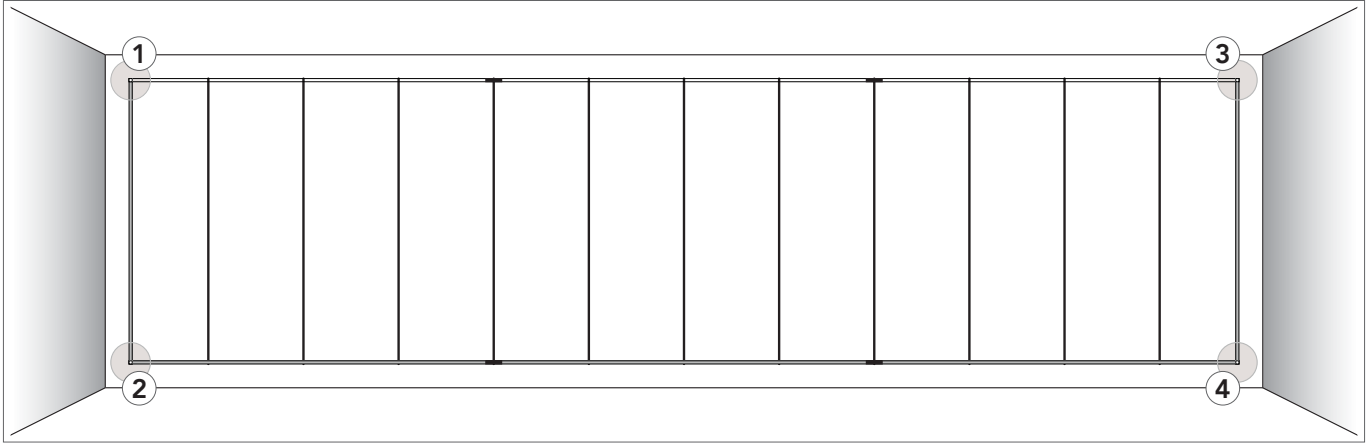

Minimum installation depth (mm)

Panels mounted in Rockfon System VertiQ C Wall are fully demountable.

The installation depth is defined as the distance from the front side of the panel to the wall substrate. D represents the exact installation depth that allows for easy panel installation and demounting.

The installation depth D is the minimum installation depth for easy panel installation and demountability.

Thickness	Dimension	D
mm		
40	2400 x 600	43

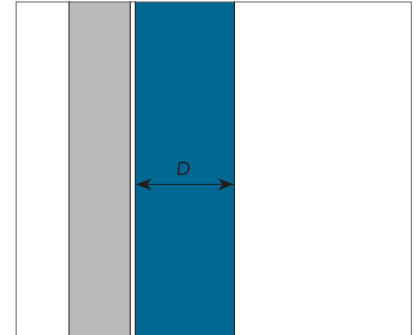

General installation recommendations

Panels

We recommend the use of clean nitrile or PU coated gloves when installing Rockfon panels in order to avoid finger prints and pollution of the surface.

For an optimum work environment, we recommend installers always observe common work practices and follow the installation advice as shown on our packaging.

Cutting is made easily with a sharp knife. All offcuts and holes must be treated according to local Building Regulations.

Note! Certain smooth matt surfaces are directional. To ensure consistency of the finished ceiling, it is important that all panels are installed in one direction, as indicated by the arrow printed on the back of each panel.

Tools

Rockfon has developed specific tools that are available on www.rockfon.co.uk

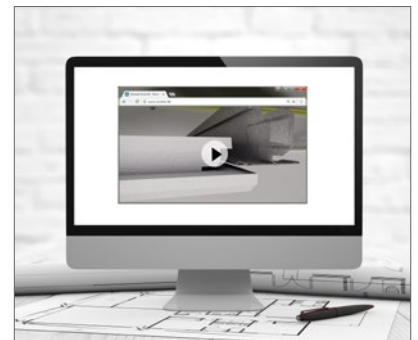

Visit our video library to see our collection of Rockfon system installation videos.

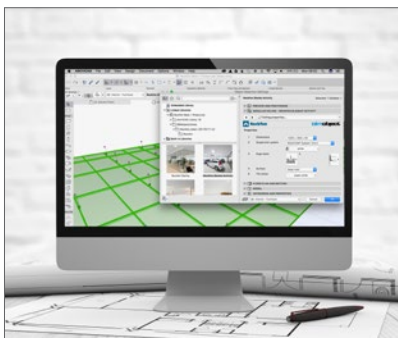

Visit our online CAD Library or BIM portal to assist you in your project design.

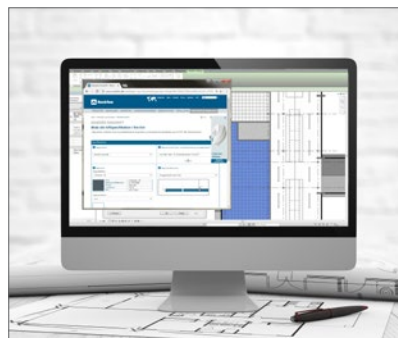

Generate specification texts for our products.

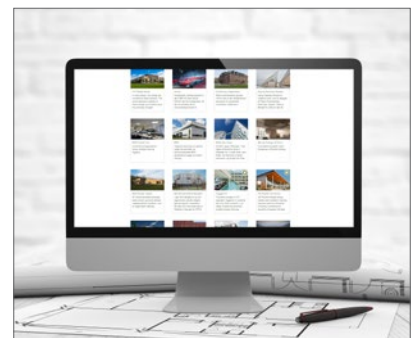

Explore our vast library of reference projects.

Rockfon® is a registered trademark
of the ROCKWOOL Group.

 twitter.com/RockfonUK

 linkedin.com/company/Rockfon-uk/

 instagram.com/Rockfon_official/

 youtube.com/RockfonUK

04:2019 | All colour codes mentioned are based on the NCS - Natural Colour System™ property of and used on license from NCS Colour AB, Stockholm 2012 or the RAL colour standard. Subject to alterations in range and product technology without prior notice. Rockfon accepts no responsibility for printing errors.



Rockfon
ROCKWOOL Limited T/A Rockfon
14th Floor, Chiswick Tower, 389 Chiswick High Road,
London W4 4AL
Tel: +44 (0) 208 222 7457
www.rockfon.co.uk