

Rockfon® System Maxispan T24 A, E™

System Description

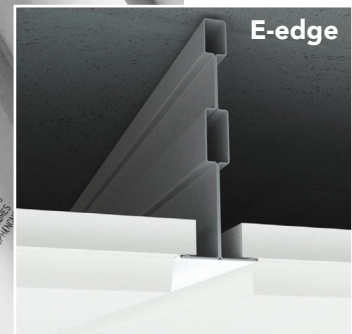
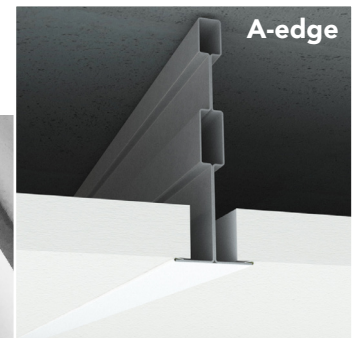

Ceiling systems for special applications Corridor

- Perfect for corridors with heavily serviced ceiling voids
- Up to 3 m span due to the strength of the profiles
- No need for hangers in the soffit

Description

The **Rockfon System Maxispan T24 A, E - Click** is a unique and cost-efficient installation system for corridors where the grid is suspended from the walls. This system comprises **Chicago Metallic 8270** and wall bracket.

The system is perfect for corridors and large, single spans typically up to 3m wide with heavily-serviced ceiling voids, providing more flexibility and freedom to install and maintain the services.

It is ideal for use with a variety of tiles including wide planks to create a more seamless appearance than traditional grids, by using less grid components.

The grid system can be combined in many different ways to suit a wide range of tile dimensions, e.g. with T24 click 2890.

Main runners have a height of 75 mm providing higher stability.

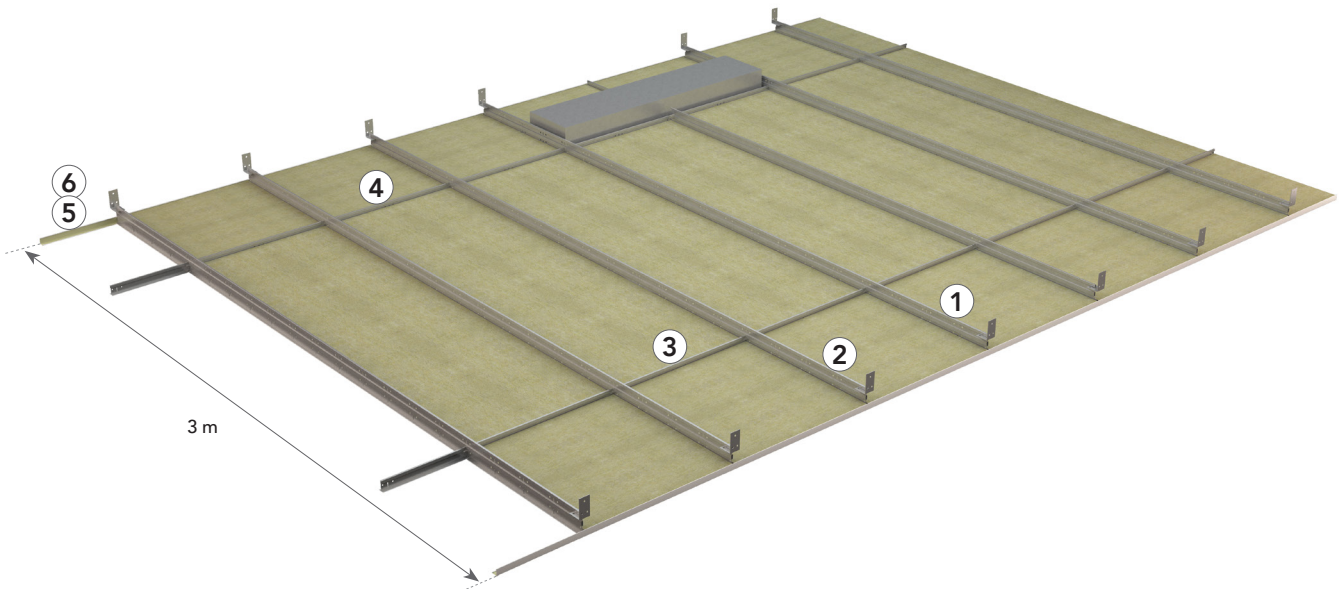

Fixing bracket.

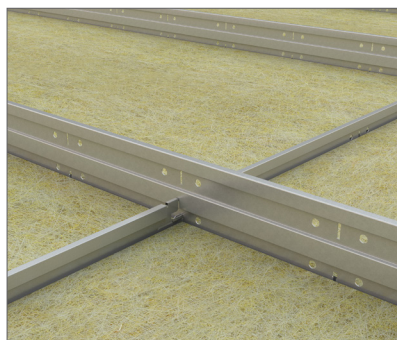

Main runner straight cut T24 Click
75 x 24 x 2400/3000mm - White 001.

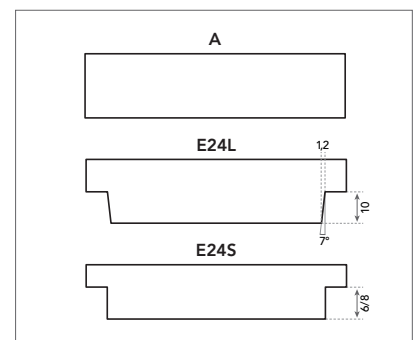

A and E edges ensuring quick installation and full demountability.

System components and consumption guide

| Tile | Chicago Metallic Maxispan T24 | | | | Wall angles | | Accessories | |
|-----------------|---|---|-------------------------|--------------------------|-----------------------------------|--|----------------|----|
| | 1 | 2 | 3 | 4 | 5 | 6 | 7 | |
| - | Universal main runner straight cut T24 Click 75 x 24 x 2400 | Main runner straight cut T24 Click 75 x 24 x 3000 | Cross tee T24 Click 600 | Cross tee T24 Click 1200 | Perimeter wall angle trim 24 x 24 | Perimeter shadow wall angle trim (new) | Fixing bracket | |
| Dimensions (mm) | Consumption/m ² | | | | | | | |
| 600 x 600 | 2.78 pcs/m ² | 1.67 lm/m ² | 1.67 lm/m ² | 1.67 lm/m ² | - | 1) | 1) | 1) |
| 1200 x 600 | 1.39 pcs/m ² | 1.67 lm/m ² | 1.67 lm/m ² | 0.83 lm/m ² | - | 1) | 1) | 1) |
| 1800 x 600 | 0.92 pcs/m ² | 1.67 lm/m ² | 1.67 lm/m ² | 0.56 lm/m ² | - | 1) | 1) | 1) |
| 2100 x 600 | 0.79 pcs/m ² | 1.67 lm/m ² | 1.67 lm/m ² | 0.48 lm/m ² | - | 1) | 1) | 1) |
| 2400 x 600 | 0.69 pcs/m ² | 1.67 lm/m ² | 1.67 lm/m ² | 0.42 lm/m ² | - | 1) | 1) | 1) |

1) Consumption depends on room size.

Tile - A and E Edge



A edge



E edge

Chicago Metallic Maxispan T24

1. Universal main runner straight cut T24 Click 75 x 24 x 2400



2. Main runner straight cut T24 Click 75 x 24 x 3000



3. Cross tee T24 Click 600



4. Cross tee T24 Click 1200



Wall angles

5. Perimeter wall angle trim



6. Perimeter shadow wall angle trim



Accessories

7. Fixing bracket



Performance



System load bearing capacity

| | | Max. Load (kg/m ²) | |
|-----------------|----------------------|--------------------------------|------------------------|
| Dimensions (mm) | Hanger distance (mm) | Max. 2.5 mm deflection | Max. 4.0 mm deflection |
| 600 x 600 | 2400 | 9.6 | 16.4 |
| 600 x 600 | 3000 | 2.9 | 5.7 |
| 1200 x 600 | 2400 | 9.5 | 16.2 |
| 1200 x 600 | 3000 | 3.1 | 6.0 |
| 1800 x 600 | 2400 | 9.3 | 15.8 |
| 1800 x 600 | 3000 | 3.2 | 6.0 |
| 2100 x 600 | 2400 | 9.2 | 15.6 |
| 2100 x 600 | 3000 | 3.2 | 6.0 |
| 2400 x 600 | 2400 | 10.6 | 17.7 |
| 2400 x 600 | 3000 | 3.2 | 6.0 |

The system's load capacity is determined from a max. deflection of the individual components corresponding to 1/500 of the span or the cumulative deflection of all structural components which does not exceed 2.5 or 4 mm. The load bearing capacity is given as regularly distributed load in kg / m², the weight of the tile is not included.



Corrosion resistance

Class B (EN13964).



Demountability

Tiles installed in Rockfon System Maxispan T24 A, E are fully demountable.



Fire resistance

Some Rockfon ceiling systems have been tested and classified in accordance with European norm EN 13501-2 and/or national norms. Please contact Rockfon.

Compatible Tiles Overview

| | | Dimensions (mm) | | | | |
|--------------------------|----------------|-----------------|------------|------------|------------|------------|
| Tiles | Thickness (mm) | 600 x 600 | 1200 x 600 | 1800 x 600 | 2100 x 600 | 2400 x 600 |
| Rockfon® Blankatm | 20 | • | • | • | | • |
| Rockfon® Scholar™ | 20 | • | • | • | • | • |
| Rockfon® Hygienictm Plus | 20-40 | • | • | | | |
| Rockfon® MediCare Plus | 20-25 | • | • | • | • | • |

All Rockfon A and E edge tiles available in dimensions mentioned above can be installed in Rockfon System Maxispan T24 A, E.

Grid Installation

Grid layout and hanger location

Rockfon A and E edge tiles can be installed in Rockfon System Maxispan T24 A, E.
Some layout options are shown below depending on the size of the tile.

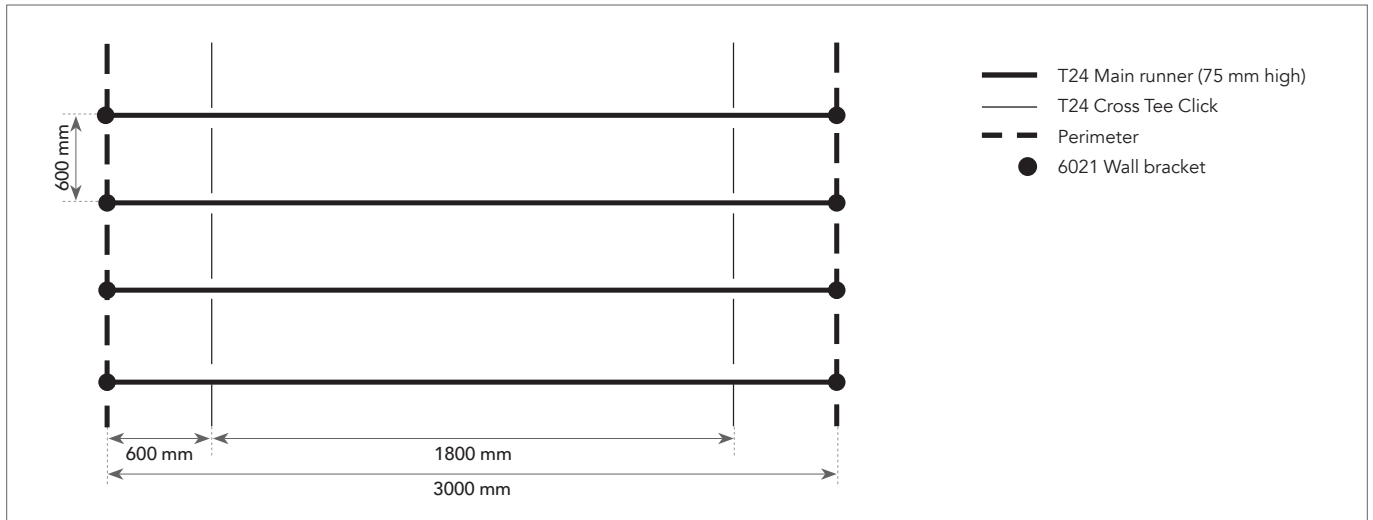

Installation requirements

During and after the grid installation, it is important to check that the T profiles are perfectly aligned horizontally. A maximum level difference of +/- 1 mm is recommended between the profiles. This tolerance is valid for all directions.

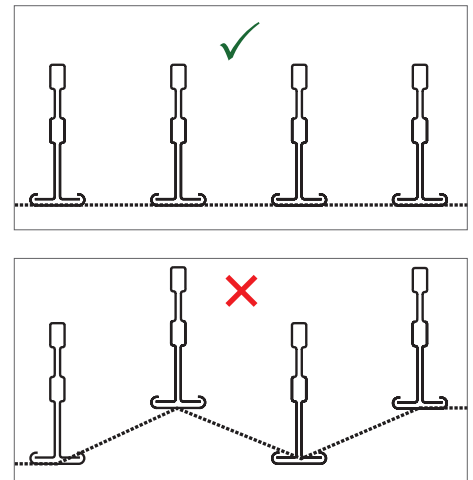

It is also important to check the squareness of the angles between the main runners and cross tees. This can be done easily by comparing the measurements of the two diagonals. See recommended tolerances on the drawing below.

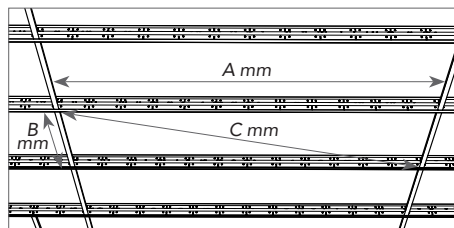

| Dimensions (A x B) | Diagonal (C) | Tolerance |
|--------------------|--------------|-----------|
| mm | | |
| 600 x 600 | 814,6 | +/- 1,0 |
| 1200 x 600 | 1309,5 | |
| 1800 x 600 | 1867,0 | |
| 2100 x 600 | 2154,4 | |
| 2400 x 600 | 2444,8 | |

Minimum installation depth (mm)

Tiles installed in Rockfon System Maxispan T24 A, E are fully demountable.

The installation depth is defined as the distance from the underside of the tile to the underside of the substrate. D represents the minimum installation depth that allows for easy tile installation and demounting.

Note: in corridors, pipework etc. will most likely negatively influence the installation depth. This should be taken into account.

D = without pipework etc.

| Tile thickness | Dimensions | D |
|----------------|---|-----|
| mm | | |
| 20 | 600 x 600, 1200 x 600, 1800 x 600, 2100 x 600, 2400 x 600 | 150 |
| 40 | 1200 x 600 | 200 |

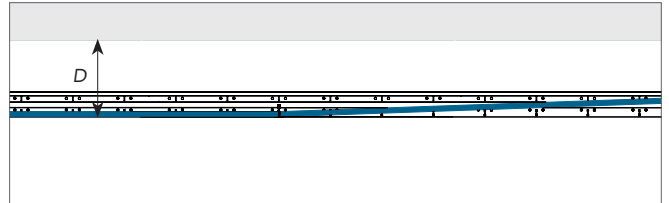

Perimeter Finish Options

Below are examples of perimeter finishing. Further details can be found on www.rockfon.co.uk

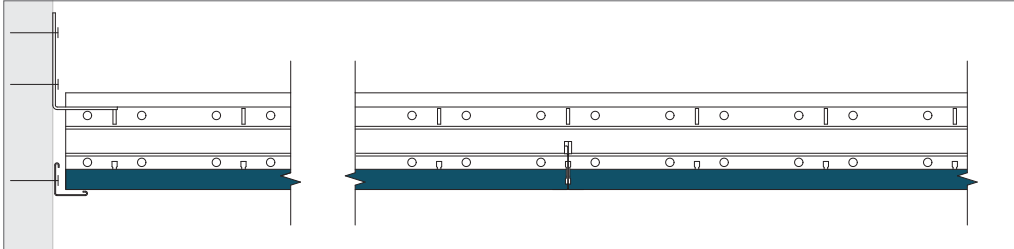

A-edge - Perimeter finish with wall angle trim.

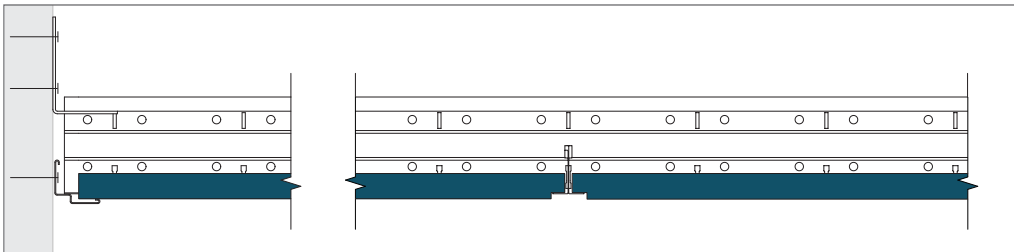

E-edge - Perimeter finish with shadow wall angle trim.

Service integration

Rockfon ceiling tiles are easy to cut and therefore it is very easy to integrate service installations in our ceiling tiles. Cutouts can be made with a simple utility knife.

When the system is load bearing, Rockfon recommends using a yoke or extra support arms that spread the weight of the service installation. The size of the yoke should not be bigger than the module size 600 x 600 and the use of extra hangers to overcome deflection in the ceiling system is strongly recommended. When using support arms to spread the weight of the installation, we

recommend spanning a maximum 600 mm and the use of extra hangers to overcome deflection in the ceiling system.

When installing a modular lighting fixture in Rockfon System Maxispan T24 A, E please be aware of the special edge design and module size of this solution. Because of the suspension grid design, a special type of luminaire should be chosen in order to create an aesthetically pleasing and level ceiling surface. The actual size of the ceiling tile is nearly its module size and the front surface of the ceiling tile sits approx. 16 mm below the front of the T-grid.

Planning

A thorough project plan will result in less re-work and less ceiling tile damage. Rockfon recommends discussing the installation thoroughly and well in advance with other installers that have to work in or near the suspended ceiling. By doing so damaged ceiling tiles and dirty spots on the finished ceiling surface can be reduced, which reduces costs on site.

Overview load bearing capacity

| | Weight of installations | | |
|---|--|-------------------|--------------------|
| | < 0.25 kg/pcs | 0.25 ≥ 3.0 kg/pcs | > 3.0 kg/pcs |
| Small service integration; Spot- or downlight, speaker, ventilation etc. | Drawing A | Drawing B | Suspend separately |
| Big service integration; Downlight, speaker, ventilation, etc. | Drawing A | Drawing B | Suspend separately |
| Modular lighting- or ventilation fixture | Drawing C; System load bearing capacity (if evenly distributed over grid in kg/m²) | | |

When installing services in Rockfon System Maxispan T24 A, E you should always follow local building regulations if more strict than the load bearing capacity guidelines Rockfon recommends in the above table and in the table on page 4.

Contact your local Rockfon technical service for more information on suitable lighting fixtures, accessories and the availability of CAD drawings for the different services integrated in Rockfon System Maxispan T24 A, E. Special solutions with integrated services are, if available, shown on page 11 of this document in the Tools section.

Drawing A

The integration of a spotlight, smoke detector, speaker, etc. (weighing < 0.25kg/pcs).
Rockfon recommends installing spotlights and downlights centralised in the tile.

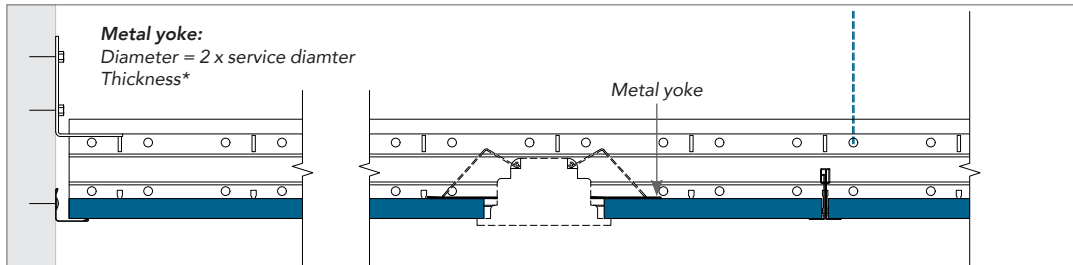

Drawing B

The integration of a downlight, spotlight, smoke detector, loud speaker, etc. (weighing $0.25 \geq 3.0$ kg/pcs). Use of an appropriate yoke to spread the load to the grid (as shown in the detail) or use of support arms to spread the load to the grid system is strongly recommended. The use of additional hangers to reduce excess deflection and a centralised installation of the lighting in the tile is strongly recommended.

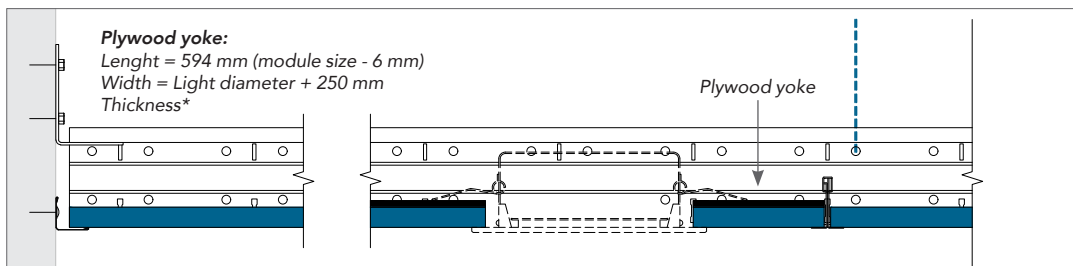

* The thickness of the plywood or metal yoke needs to be adapted in function of the weight, size and position of your service integration (e.g. downlight or speaker). The Plywood or metal yoke itself may not deflect after installing your service integration.

Drawing C

The integration of a modular luminaire or air vent (evenly distributed over grid), weighing max. the system loading capacity. If the load capacity of the system is likely to be exceeded it is strongly recommended to suspend the service independently. Alternatively use services equipped with supporting arms on minimum two opposite sides to transfer the weight of the service to the top of the bulb of the grid. This is safer and reduces the likelihood of T rotation.

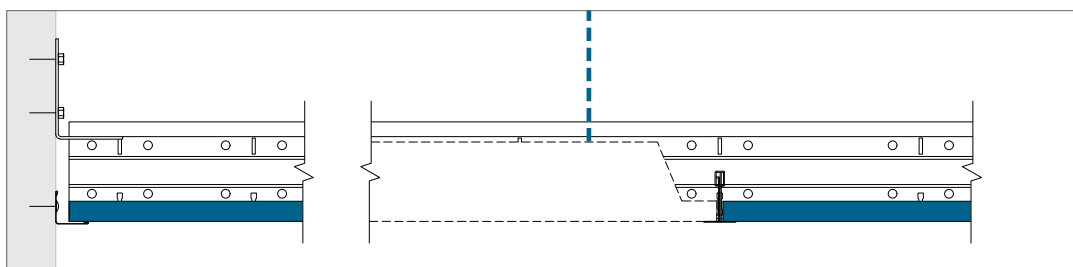

Specific Solutions

Fixation clip

This clip can be twist fixed onto the bottom of the T24 profile and provides the option to suspend signs or advertisements underneath the clip. The clip is in the same colour (white) as the grid.

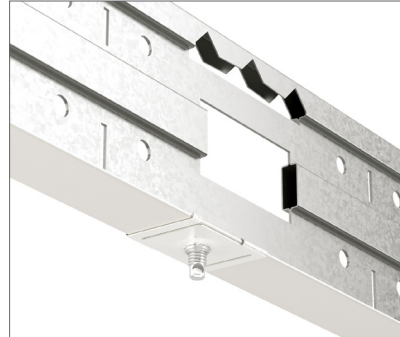

Hold down clip

For maintaining tiles in place, Rockfon can supply this hold down clip. For fire resisting/protecting ceilings, tiles should be clipped at the rate of 2 clips per 600 mm edge and 3 clips per 1200 mm edge. In small rooms, entrance areas, staircases and other areas which may be subject to pressure differences between room and ceiling void, it is recommended to alleviate pressure build up with the use of vents or grills. Alternatively, in some situations, clips can be used to secure the tiles into the grid system.

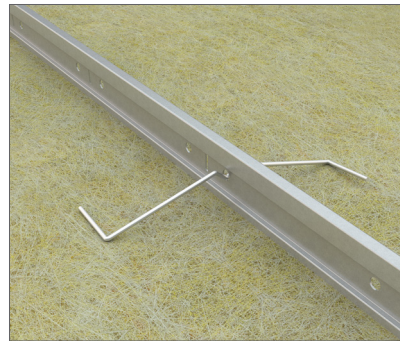

90° bracket

90° bracket gives you the freedom of installing a cross tee on a MR or CT without having a slot available. Due to its height it gives the profile the exact installing height to have a smooth connection. 90° bracket can also be used to attach/fix the profiles against the wall.

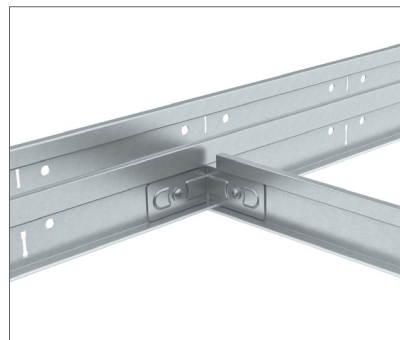

General installation recommendations

Junction between ceiling and wall or other vertical surface

The perimeter trim should be fastened to the vertical surfaces at the required level, using the appropriate fixings every 300-450 mm. Ensure that butt joints between adjoining lengths of trim are neat and that the trim is free from kinks and that it remains true and level. For the best aesthetics, use as long a length of trim as possible. The minimum recommended cut length is 300 mm.

Timber trims, timber shadow battens and metal

Shadow mouldings should not be used with fire resisting/protecting ceilings.

Junction between ceiling and curved vertical surface

The use of a preformed curved perimeter trim is the most appropriate method. We can provide details of curved perimeter trims on request.

Corners

Perimeter trims should be neatly mitred at all corner joints. Overlap mitres are acceptable for metal trims on internal corner joints, unless specified otherwise.

Suspension grid

Unless specified otherwise, the ceiling system should be built from the centre of the room outwards. The hangers should be fastened to the main runner at every 1200 mm centres, or less with a greater load. For an optimal finish, we recommend that the perimeter tile has a width greater than 200 mm.

Main runners should be positioned at 1200 mm centres for 600 x 600 mm and 1200 x 600 mm module sizes. For 1800 x 600 mm module size, main runners are installed at 1800 mm centres.

For proper grid installation, ensure the T profiles are perfectly aligned, horizontally and diagonals of modules are equal (see requirements and tolerances on page 5). Main runner joints should be staggered and there should be a hanger positioned within 150 mm of the fire expansion element/cut-out and within 450 mm of the end of the main runner where it terminates at a perimeter.

Additional hangers may be necessary to support the weight of ceiling services. When using direct hangers, a fixing nail should be used to lock the hanger on to the bulb of the main runner.

Tiles

It is recommended to use clean nitrile or PU coated gloves when mounting Rockfon tiles in order to avoid finger prints and pollution of the surface.

For an optimised work environment, we recommend installers always observe common work practices and follow the installation advice as shown on our packaging.

Cutting is made easily with a sharp knife. All offcuts and holes must be treated according to local Building Regulations.

The mounting of 1800 x 600 mm tiles is recommended to be done by two persons.

Note! Certain smooth matt surfaces are directional. To ensure consistency of the finished ceiling, it is important that all tiles are mounted in one direction, as indicated by the arrow printed on the back of each tile.

Tools

Rockfon has developed specific tools that are available on www.rockfon.co.uk



Visit our online CAD Library or BIM portal to assist you in your project design.

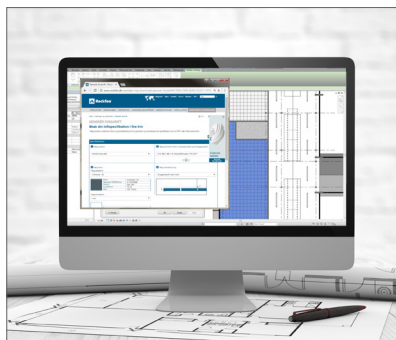

Generate specification texts for our products on our website.



Explore our vast library of reference projects on our website.

Rockfon® is a registered trademark
of the ROCKWOOL Group.

 [linkedin.com/company/Rockfon-as](https://www.linkedin.com/company/Rockfon-as)

 [pinterest.dk/Rockfon](https://www.pinterest.dk/Rockfon)

 [youtube.com/RockfonOfficial](https://www.youtube.com/RockfonOfficial)

 [facebook.com/RockfonOfficial](https://www.facebook.com/RockfonOfficial)

 [instagram.com/Rockfon_Official](https://www.instagram.com/Rockfon_Official)

11.2020 | All colour codes mentioned are based on the NCS - Natural Colour System® property of and used on license from NCS Colour AB, Stockholm 2012 or the RAL colour standard. Subject to alterations in range and product technology without prior notice. Rockfon accepts no responsibility for printing errors.



Rockfon
ROCKWOOL Limited T/A Rockfon
14th Floor, Chiswick Tower, 389 Chiswick High Road,
London W4 4AL
Tel: +44 (0) 208 222 7457
www.rockfon.co.uk