

Rockfon® System dB T24 A, E™

System Description

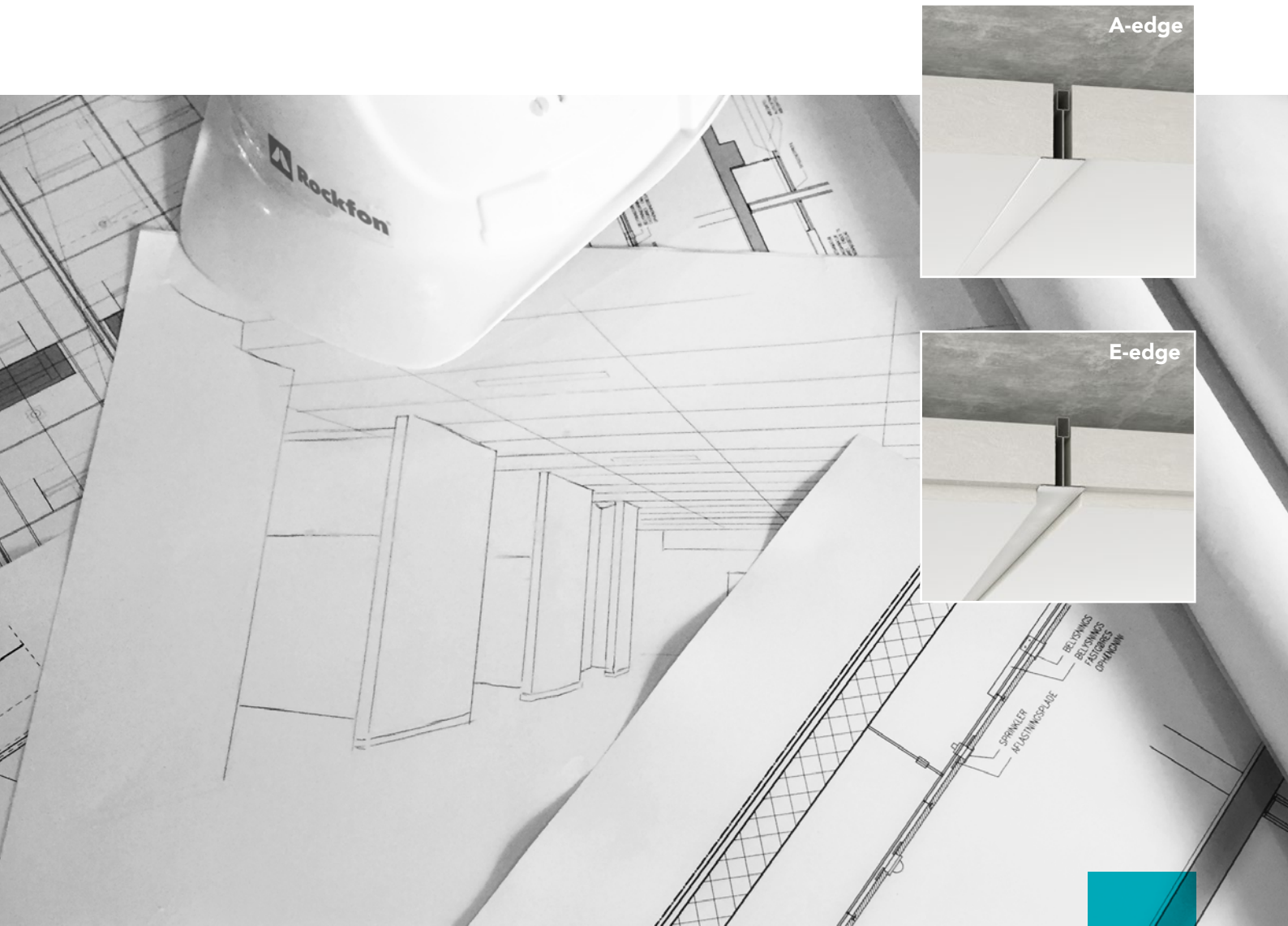

Visible/Semi-concealed ceiling system Standard

- Superior combination of sound absorption and sound insulation for reducing room-to-room sound transmission
- Visible and semi-concealed grid ceiling system
- Every single tile is demountable for easy and fast access to installations

Description

Rockfon® System dB T24 A, E™ is a semi-concealed and fully exposed grid ceiling system that is specialised in reducing room-to-room sound transmission by offering the best combination of sound absorption and sound insulation.

It combines our Chicago Metallic™ T24 Click 2890 grid and Rockfon dB A-edge tiles for a visible ceiling system or our dB E-edge tiles for a semi-concealed ceiling finish with unique acoustic properties. Chicago Metallic T24 Click 2890 comprises a click joggled connections between the main runner and cross tees, which provides easy and quick installation, as well as being fully demountable and stable.

The Chicago Metallic T24 Click 2890 main runners and cross tees are 24 mm wide with a uniform depth of 38 mm, ensuring good strength and easy service integration.

Critical areas for sound transmission are where the partition wall meets the ceiling or around light fittings. The range of dB accessories is designed to combat room-to-room sound transmission, installing Rockfon® Soundstop™ / Rockfon® Acoustimass™ is an excellent solution to diminish noise transfer between ceilings and floors plenums. Install Rockfon® Rocklux® to limit sound transmissions through technical installations, improving confidentiality and privacy. Integration of light fixtures and ventilation ducts is straight forward. Tiles mounted in this system are easily and fully demountable.

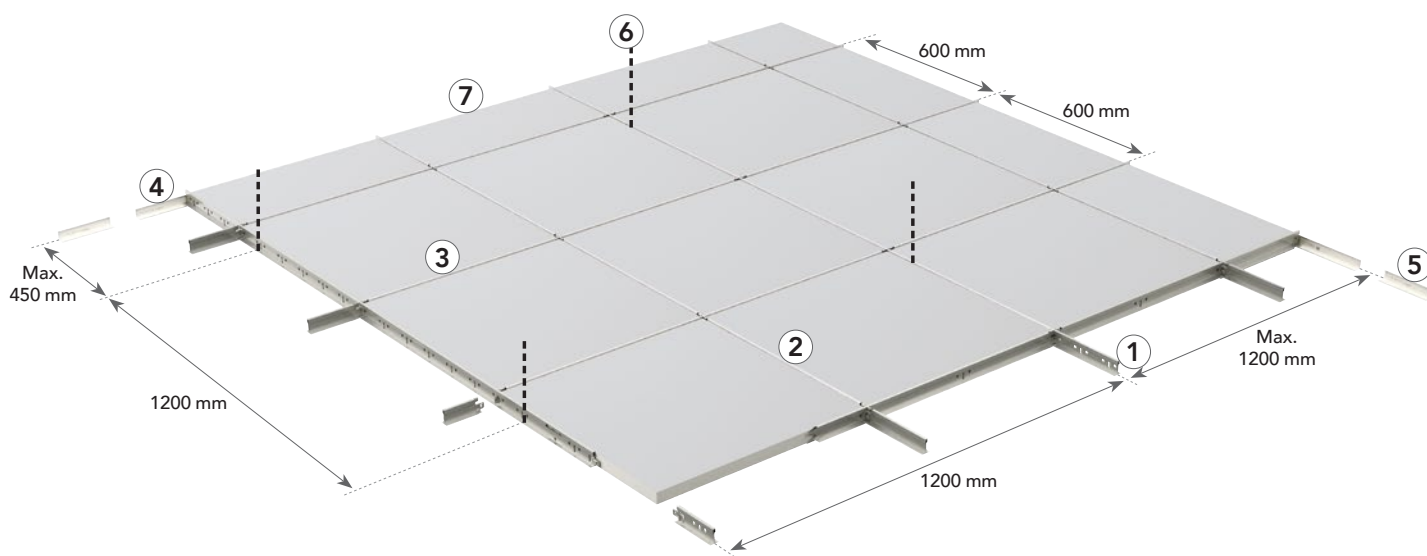

38 mm full height main runners and cross tees for stability and easy service integration.

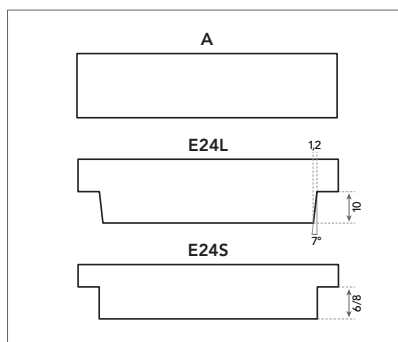

Visible grid and semi-concealed grid ceiling system with A and E edge tiles.

System components and consumption guide

Tile	Chicago Metallic T24 Click 2890					Wall angles	Accessories		
	1	2	3			5	6	7	
A, E edge	Main runner T24 Click/Hook 3600	Cross tee T24 Click 600	Cross tee T24 Click 1200	Cross tee T24 Click 1500	Cross tee T24 Click 1800	Perimeter wall angle trim	Hanger	Wall spring fixt	
Dimensions (mm)	Consumption/m ²								
600 x 600	2.78 pcs/m ²	0.83 lm/m ²	0.83 lm/m ²	1.67 lm/m ²	-	-	1)	0.70 pcs/m ²	1)
1200 x 600	1.39 pcs/m ²	0.83 lm/m ²	-	1.67 lm/m ²	-	-	1)	0.70 pcs/m ²	1)

1) Consumption depends on room size.

Tile - A and E edge



A edge



E edge

Chicago Metallic T24 Click 2890

1. Main runner T24 Click 3600



2. Cross tee T24 Click 600



3. Cross tee T24 Click 1200



Wall angle

5. Perimeter wall angle trim



Accessories

6. Hanger



7. Wall spring fixt



8. Direct fixing bracket

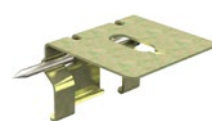

Performance



System load bearing capacity

		Max. Load (kg/m ²)	
Hanger distance (mm)	Dimensions (mm)	Max. 2.5 mm deflection	Max. 4.0 mm deflection
1200	1200 x 600	18.3	26.1
1200	1500 x 600	8.3	13.7
1200	1800 x 600	4.0	6.8
1200	2100 x 600	12.0*	15.3*
1200	2400 x 600	7.5*	12.8*

* 75 mm high cross tees.

The system's load capacity is determined from a max. deflection of the individual components corresponding to 1/500 of the span or the cumulative deflection of all structural components which does not exceed 2.5 or 4.0 mm. The loading capacity is given as regularly distributed load in kg/m², the weight of the tile is not included.



Corrosion resistance

Class B (EN13964)



Demountability

Tiles mounted in Rockfon System dB T24 A, E are fully demountable.



Fire resistance

Some Rockfon ceiling systems have been tested and classified in accordance with European norm EN 13501-2 and/or national norms. Please contact Rockfon.



Sound insulation

The $D_{n,f,w}$ value in dB quantifies the longitudinal sound insulation provided by the ceiling between two rooms. The higher the $D_{n,f,w}$ value, the better the room-to-room sound insulation.

Tiles	Without sound barrier			Acoustimass			Soundstop 30 dB		
	1	2	3	1	2	3	1	2	3
Rockfon Blanka dB 35 A	35*	33	35	45	44	44	50	49	50
Rockfon Blanka dB 41 A	41*	36	40	52	48	50	55	52	54
Rockfon Blanka dB 43 A	43*	37	41	54	50	52	56	53	55
Rockfon Blanka dB 46 A	46*	38	42	55	49	51	58	54	55
Rockfon Blanka dB 41 E24	38	34	37	49	46	47	53	50	51
Rockfon Blanka dB 43 E24	40	35	38	50	46	48	55	50	52
Rockfon Blanka dB 46 E24	42	36	39	50	46	48	55	51	53

1: Without light fixtures.

2: With light fixtures (2x4 TBS 260 light fixtures).

3: With light fixtures (2x4 TBS 260 light fixtures) + Rockfon Rocklux.

*Measured values.

- Performance highly depends on the installation and system.
- Performance will be reduced in case you install lights, then you have the possibility to add sound caps to come back to the initial values.
- Adding sound barriers will even increase your general performance.

Compatible Tiles Overview

			Dimensions (mm)	
Tiles	Edge	Thickness	600 x 600	1200 x 600
Rockfon Blanka dB 35	A24	25	•	•
	E24S8		•	•
	E24L10			
Rockfon Blanka dB 41	A24	35	•	•
	E24S8		•	•
	E24L10			
Rockfon Blanka dB 43	A24	40	•	•
	E24S8		•	•
	E24L10			
Rockfon Blanka dB 46	A24	50	•	•
	E24S8		•	•
	E24L10			

Grid Installation

Grid layout and hanger location

Rockfon A24 and E24 edge tiles can be installed in Rockfon System dB T24 A, E. Some layout options are shown below depending on the size of the tile.

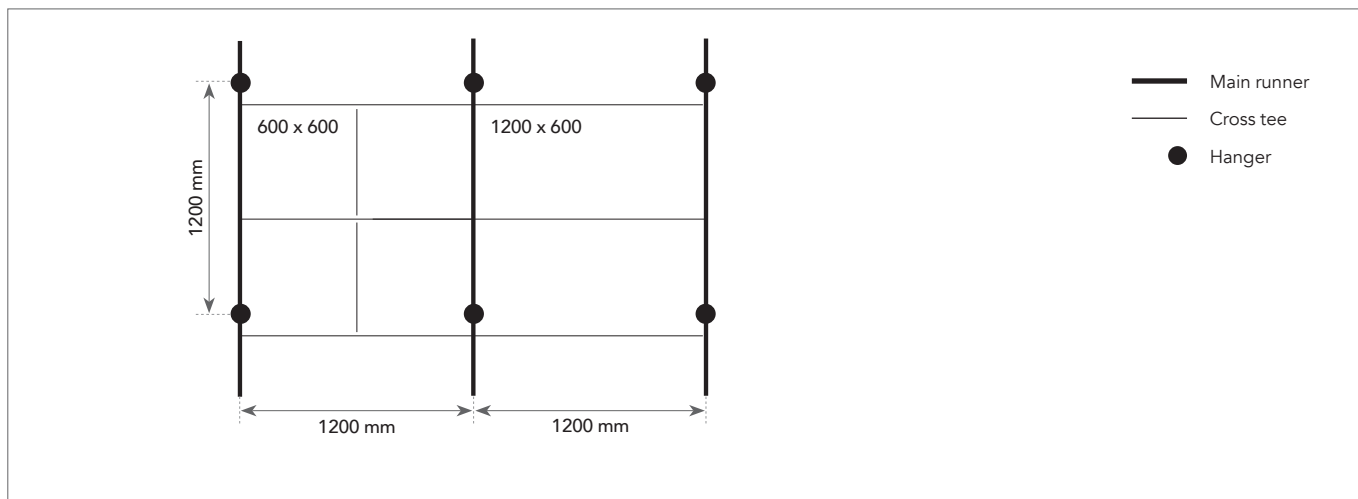

Installation requirements

During and after grid installation, it is important to check that T profiles are perfectly aligned horizontally. A maximum level difference of +/- 1 mm is recommended between profiles and should not be accumulated. This tolerance is valid for all directions.

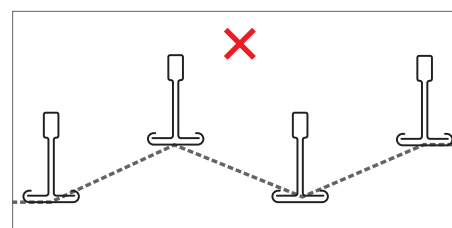
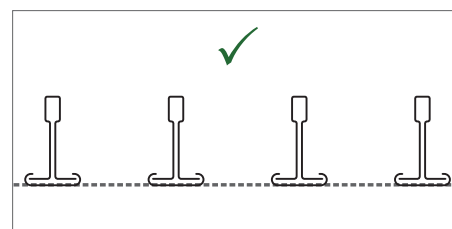

It is also important to check the squareness of the angles between the main runners and cross tees. This can be easily done by comparing the measurements of the two diagonals. See recommended tolerances on the drawings below.

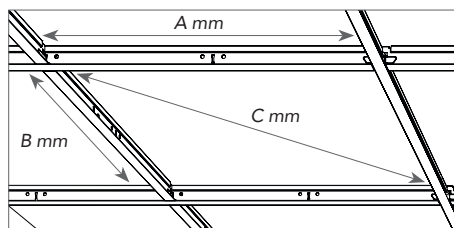

Dimensions (A x B)	Diagonal (C)	Tolerance
mm		
600 x 600	814.60	+/- 1.0
1200 x 600	1309.50	

Minimum installation depth (mm)

Tiles installed in Rockfon System dB T24 A, E are fully demountable. The installation depth is defined as the distance from the underside of the tile to the underside of the substrate, where the hangers are fixed. D is the minimum installation depth for easy tile installation and demountability.

When installing Rockfon Rocklux a minimum Plenum height of 214 mm is needed. (For the 600 x 600 modules the demounting of the short cross tee is needed in order to create a larger installation area).

Tile thickness	Dimensions	D
mm		
35 - 50	600 x 600 1200 x 600	100

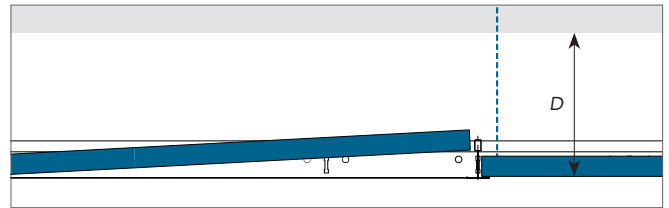

Perimeter Finish Options

Below are examples of perimeter finishing. Further details can be found on www.rockfon.co.uk

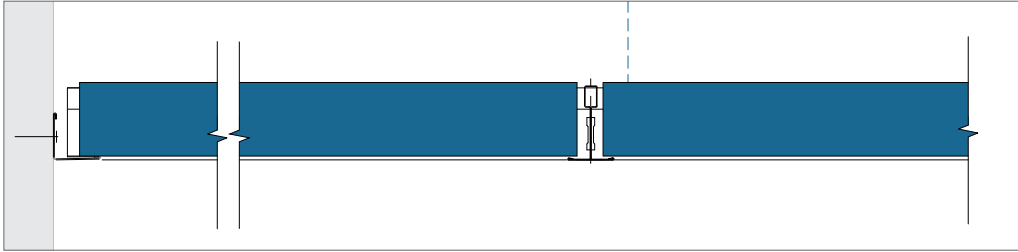

A-edge - Perimeter finish with wall angle trim.

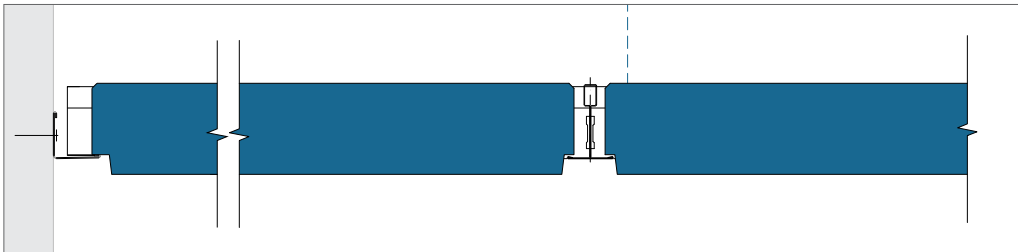

E-edge - Perimeter finish with wall angle trim.

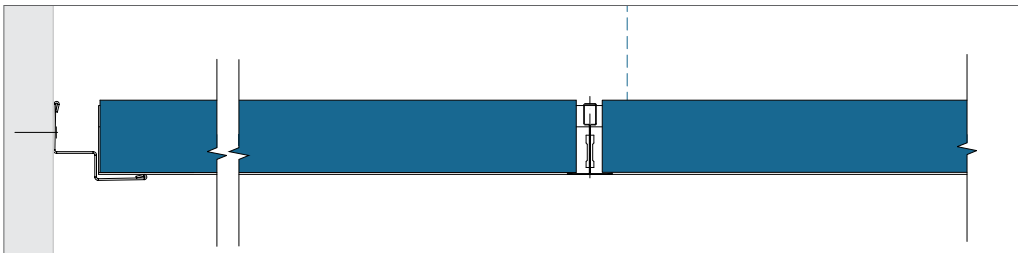

A-edge - Perimeter finish with W-wall angle trim.

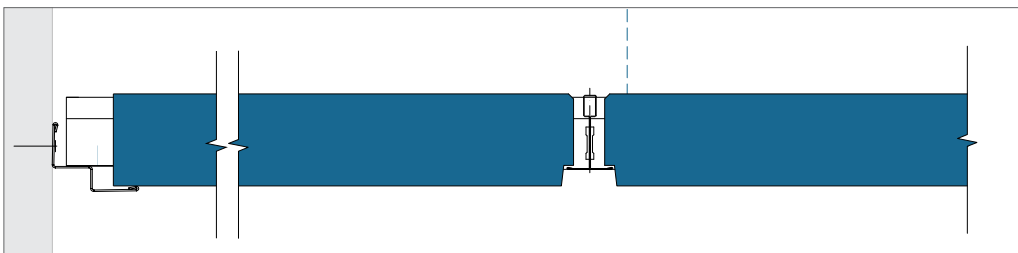

E-edge - Perimeter finish with W-wall angle trim.

Service integration

Rockfon ceiling tiles are easy to cut and therefore it is very easy to integrate services in Rockfon tiles. The cut-outs can be made with a simple utility knife.

When the ceiling system is installed to bear load, Rockfon recommends using support arms or a yoke that transfers the weight of the service to the grid. The size of the yoke should not be bigger than module 600 x 600 mm and the use of additional hangers to overcome deflection in the ceiling system is strongly recommended.

When using support arms to spread the weight of the installation, Rockfon recommends spanning a maximum of 600 mm and where necessary the use of additional hangers to counteract potential ceiling deflection. For more information on the load bearing capacities of this Rockfon System dB T24 A, E, please refer to the table below.



System load bearing capacity

Hanger distance (mm)	Dimensions (mm)	Max. Load (kg/m²)	
		Max. 2.5 mm deflection	Max. 4.0 mm deflection
1200	600 x 600	11.1	18.4
1200	1200 x 600	12.1	19.8

The system's load capacity is determined from a max. deflection of the individual components corresponding to 1/500 of the span or the cumulative deflection of all structural components which does not exceed 2.5 or 4.0 mm. The loading capacity is given as regularly distributed load in kg/m², the weight of the tile is not included.

Planning

A thorough planning and installation scheduling of the project/site will result in less re-work and less ceiling tile damage. Rockfon recommends discussing the installation planning thoroughly and well in advance with other installers that have to work in or near the suspended ceiling. By doing so damaged ceiling tiles and dirty spots on the finished ceiling surface can be avoided, which reduces project costs.

Overview load bearing capacity

	Weight of installations		
	< 0.25 kg/pcs	0.25 ≥ 3.0 kg/pcs	> 3.0 kg/pcs
Small service integration; Spotlight or downlight, speaker, ventilation etc.	Drawing A	Drawing B	Independently suspend
Large service integration; Downlight, speaker, ventilation, etc.	Drawing A	Drawing B	Independently suspend
Modular lighting- or ventilation fixture	Drawing C; System load bearing capacity (if uniformly distributed over grid in kg/m²)		

When installing services in Rockfon System dB T24 A, E you should always follow local building regulations if more strict than the load bearing capacity constraints Rockfon recommends in the above table.

Contact your local Rockfon technical service for more information on suitable lighting fixtures and accessories and availability of CAD drawings of the different services integrated in Rockfon System dB T24 A, E. Special solutions with integrated services are, if available, shown on page 12 of this document; 'Tools'.

Drawing A

The integration of a spotlight, smoke detector, speaker, etc. (weighing < 0,25 kg/pcs).
 Rockfon recommends installing spotlights and downlights centralized in the tile.

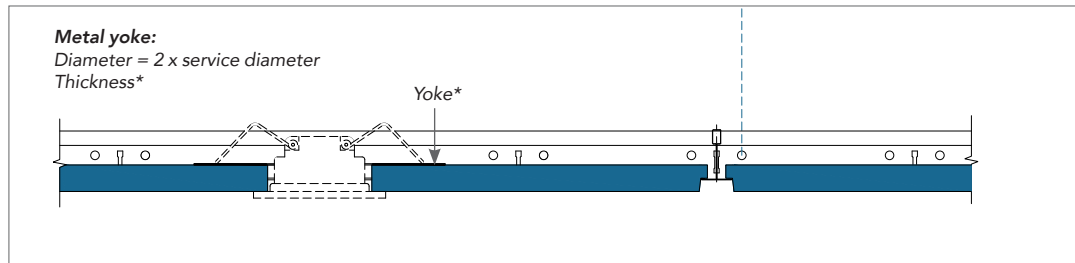

Drawing B

The integration of a downlight, spotlight, smoke detector, loud speaker, etc. (weighing $0,25 \geq 3,0$ kg/pcs).
 Usage of an appropriate yoke to spread the load to the grid (as shown in the detail) or usage of support arms to spread the load to the grid system is strongly recommended. The use of additional hangers to avoid excess deflection and a centralized installation of the lighting in the tile is strongly recommended.

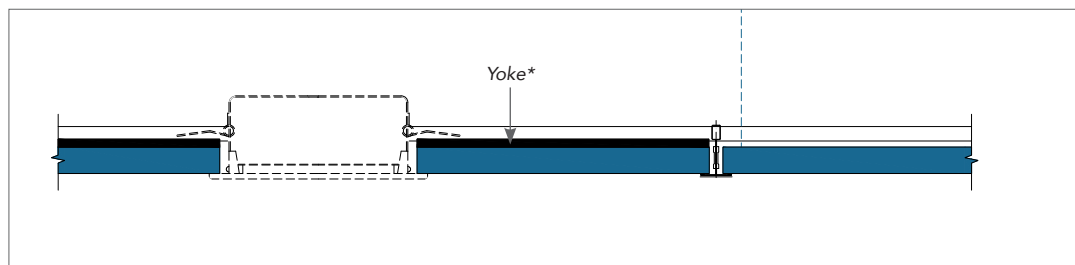

* The thickness of the plywood or metal yoke needs to be adapted in function of the weight, size and position of your service integration (e.g. downlight or speaker). The Plywood or metal yoke itself may not deflect after installing your service integration.

Drawing C

The integration of a modular luminaire or air vent (evenly distributed over grid), weighing max. the system loading capacity. If the load capacity of the system is likely to be exceeded it is strongly recommended to suspend the service independently. Alternatively use services equipped with supporting arms on minimum two opposite sides to transfer the weight of the service to the top of the bulb of the grid. This is safer and reduces the likelihood of T rotation.

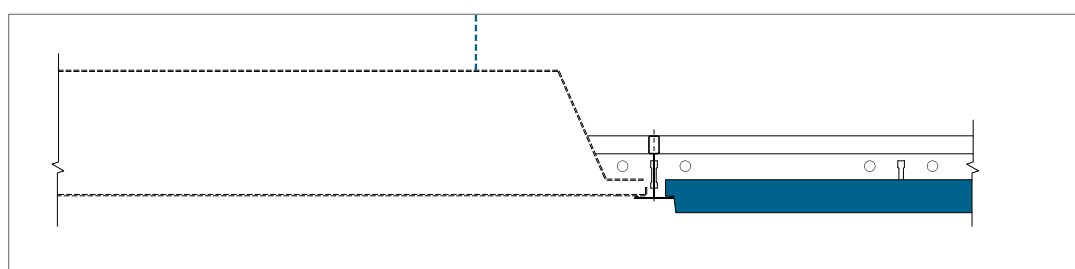

Specific Solutions

Rockfon® Soundstop™ / Rockfon® Acoustimass™

Bandrafter profiles are perfect for placing sound barriers. Install Rockfon® Soundstop™/ Rockfon® Acoustimass™ to insulate noise transmitted between rooms and the plenum. It can also be used to prevent the spread of fire in the ceiling void.

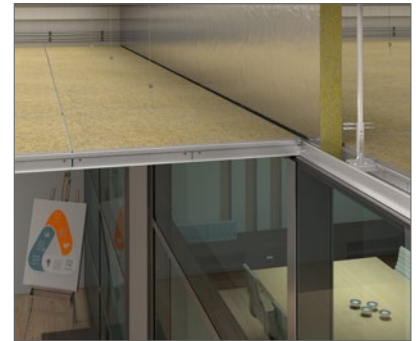

Rockfon® Rocklux®

To limit sound transmissions through technical installations, improving confidentiality and privacy, install Rockfon® Rocklux®. Rockfon Rocklux is delivered flat and must be assembled. To install, simply bend along the pre-slitted line.

The alu tape (included in the box) should be used on all 4 sides in order to reach the $D_{n,f,w}$ values.



External dimension after folding	Internal dimension after folding	Dimension when flat in a box	Suitable technical installation dimensions
mm			
785 x 785 x 160	725 x 725 x 130	1105 x 1105 x 30	600 x 600, 1200 x 600*
1460 x 425 x 160	1400 x 365 x 130	1780 x 745 x 30	1200 x 300

* Use 2 pieces of Rockfon Rocklux 1105 x 1105 x 30 mm for these dimensions.

General installation recommendations

Junction between ceiling and wall or other vertical surface

The perimeter trim should be fastened to vertical surfaces at the required level using appropriate fixings replace by every 300-450 mm centres. Ensure that butt joints between adjoining lengths of trim are neat and that the trim is free from kinks and remains true and level. For the best aesthetics, use as long a length of trim as possible. The minimum recommended cut length is 300 mm.

Timber trims, timber shadow battens and metal Shadow mouldings should not be used with fire resisting/protecting ceilings.

Junction between ceiling and curved vertical surface

The use of a preformed curved perimeter trim is the most appropriate method. Rockfon can provide details of curved perimeter trims on request.

Corners

Perimeter trims should be neatly mitred at all corner joints. Overlap mitres are acceptable on metal trims on internal corner joints unless specified otherwise.

Suspension grid

Unless specified otherwise, the ceiling should be set out symmetrically and where possible, perimeter tiles should be greater than 200 mm in width. The hangers should be fastened with appropriate top fixings and to the main runners at 1200 mm centres (or less with greater load).

Main runners should be positioned at 1200 mm centres for 600 x 600 mm and 1200 x 600 mm module sizes.

For proper grid installation, ensure the T profiles are perfectly aligned, horizontally and diagonals of modules are equal (see requirements and tolerances on page 5). Main runner joints should be staggered and there should be a hanger positioned within 150 mm of the fire expansion element/cut-out and within 450 mm of the end of the main runner where it terminates at a perimeter.

Additional hangers may be necessary to support the weight of ceiling services. When using direct hangers, a fixing nail should be used to lock the hanger on to the bulb of the main runner.

Tiles

It is recommended to use clean nitrile or PU coated gloves when installing Rockfon tiles in order to avoid finger prints and pollution of the surface.

Cutting is made easily with a sharp knife. All off-cuts and holes must be treated according to local Building Regulations.

For an optimised work environment, we recommend installers always observe common work practices and follow the installation advise as shown on our packaging.

Tools

Rockfon has developed specific tools that are available on www.rockfon.co.uk



Visit our online CAD Library or BIM portal to assist you in your project design.

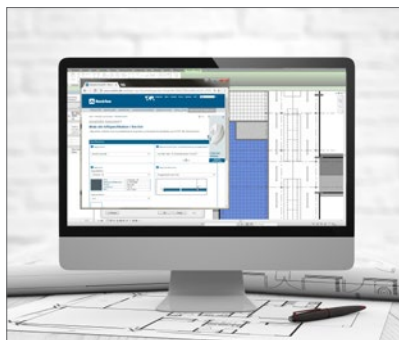

Generate specification texts for our products on our website.



Explore our vast library of reference projects on our website.

Rockfon® is a registered trademark
of the ROCKWOOL Group.

 [linkedin.com/company/Rockfon-as](https://www.linkedin.com/company/Rockfon-as)

 [pinterest.dk/Rockfon](https://www.pinterest.dk/Rockfon)

 [youtube.com/RockfonOfficial](https://www.youtube.com/RockfonOfficial)

 [facebook.com/RockfonOfficial](https://www.facebook.com/RockfonOfficial)

 [instagram.com/Rockfon_Official](https://www.instagram.com/Rockfon_Official)

06.2021 | All colour codes mentioned are based on the NCS - Natural Colour System[®] property of and used on license from NCS Colour AB, Stockholm 2012 or the RAL colour standard. Subject to alterations in range and product technology without prior notice. Rockfon accepts no responsibility for printing errors.



Rockfon
ROCKWOOL Limited T/A Rockfon
14th Floor, Chiswick Tower, 389 Chiswick High Road,
London W4 4AL
Tel: +44 (0) 208 222 7457
www.rockfon.co.uk