

DATASHEET

Chicago Metallic[™] T24 Click D2890

ECR Class D

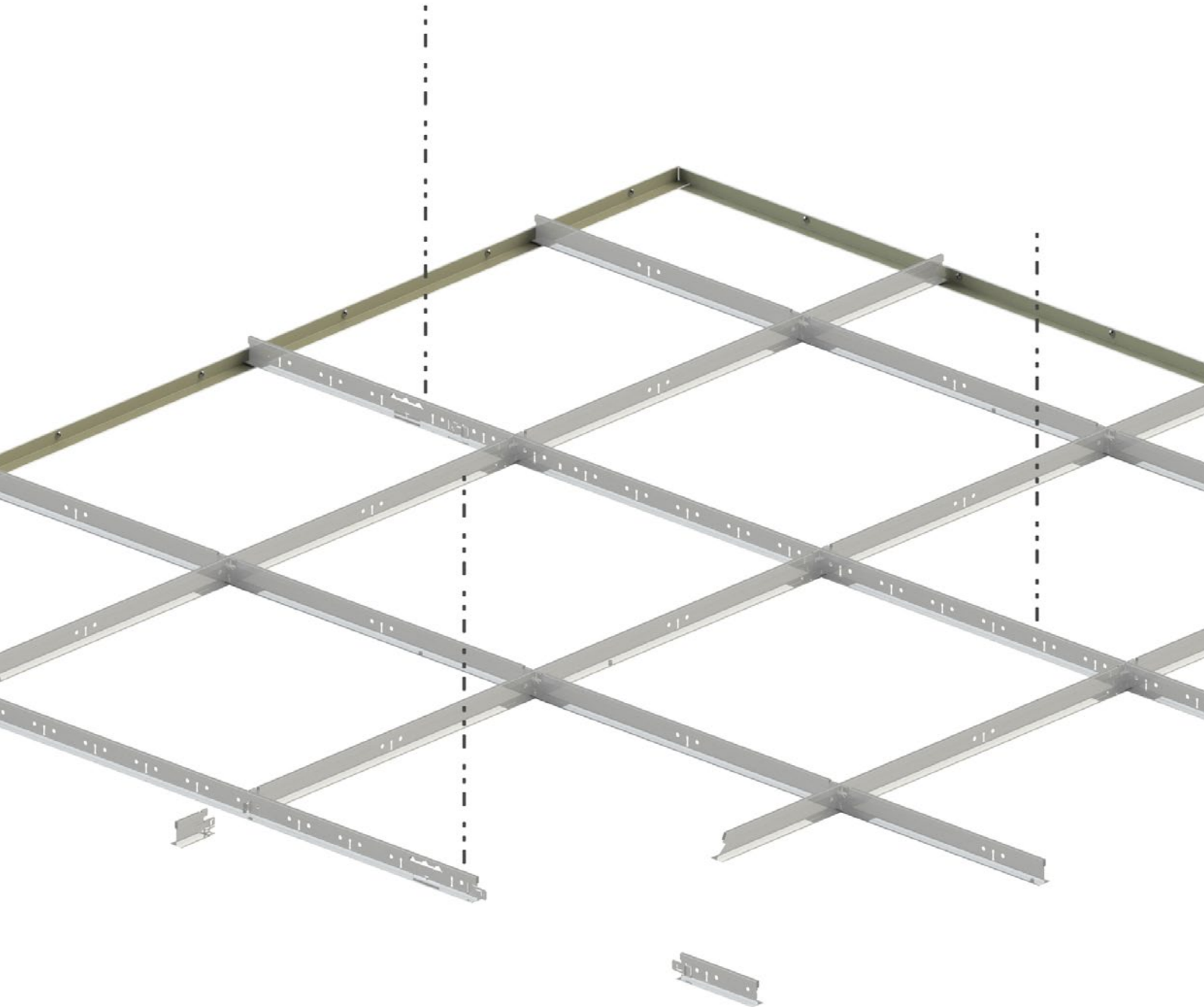

Sounds Beautiful

Chicago Metallic™ T24 Click D2890 ECR Class D

- 24mm grid with Enhanced Corrosion Resistant finish
- All grid components are extra galvanised with double side painting
- The system includes accessories and wall angles also with Class D protection
- For use in harsh, Class D environments, eg. swimming pool areas, kitchens etc.

Cross-section

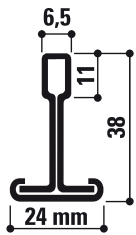

Compatible tiles

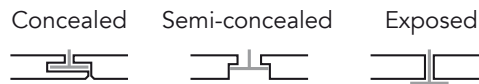

Coupling

Joggled end



Assortment

Product group		Component description	Height (mm)	Length (mm)	Colour	Pcs per pack	Lm per pack	Kg per pack	Carton per pallet	Kg per pallet
Main runner										
T24 D MR CL&HK		Main runner T24 Click ECR Class D	38	3600	001	15	54	23.6	70	1649
Cross tee										
T24 D CT CLICK		Cross tee T24 Click ECR Class D	38	600	001	45	27	9.8	70	684
T24 D CT CLICK			38	1200	001	45	54	18.9	72	1357
T24 D CT CLICK			38	1800	001	25	45	19.6	60	1176
Wall angle options										
L24x24 D		ECR Class D Perimeter trim / Hanger 24 x 24 x 3050mm		3050	001	40	122	27	60	1620
L19x24 D		L-wall angle 24 x 19mm ECR Class D	24	3050	001	40	122	23	60	1379
Accessories										
FH B D		Special hanger bent / ECR class D	57.5			100		1.5		
TR D M6		Threaded rod M6 / ECR class D / L=1000mm		1000		100		16.7		
NUT D M6		Nut M6 / ECR class D				100		0.2		
HDC 1		Plastic hold down clip for tile thickness 15-20 mm (A edge), 15-30 mm (E edge), 20-25 mm (X, M, Z edge), 20-30 mm (D edge)				100		1.34	48	80
HDC 2		Plastic hold down clip for tile thickness 25-30 mm (A edge), 40 mm (E, D edge)				150		1.65	48	95
HDC 3		Plastic hold down clip for tile thickness 40 mm (A edge), 50 mm (D edge)				100		1.12	96	125

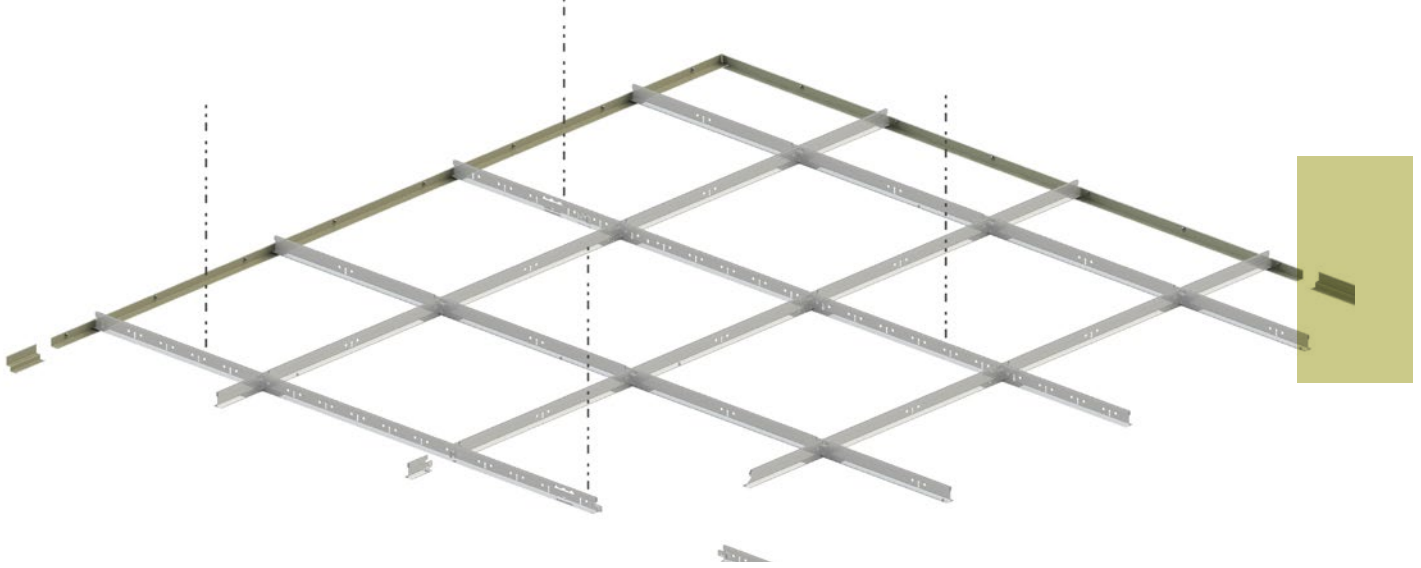

Position of slots and suspension holes

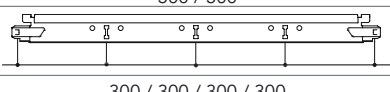
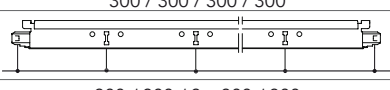
Product group	Component description	Height (mm)	Length (mm)	Slots	Distance between slots (mm)
T24 D MR CL&HK	Main runner T24 Click ECR Class D	38	3600	36	 50 / 100 / 34 x 100 / 50
T24 D CT CLICK	Cross tee T24 Click ECR Class D	38	600	1	 300 / 300
T24 D CT CLICK		38	1200	3	 300 / 300 / 300 / 300
T24 D CT CLICK		38	1800	5	 300 / 300 / 3 x 300 / 300

Performance



Load bearing capacity

Hanger distance (mm)	Module size (mm)	Kg/m ²	
		Maximum deflection	
		2.5 mm	4.0 mm
1200	600 x 600	9.9	16.5
1200	1200 x 600	10.9	17.9
1200	1800 x 600	3.3	5.7



Reaction to fire

A1



Corrosion Resistance

D



Environment

Fully recyclable

Understanding the performance of Chicago Metallic™ grids and accessories



Reaction to fire

Reaction to fire is classified in accordance with EN 13501-1. Chicago Metallic steel grids and accessories are non-combustible.



Fire resistance

A range of Chicago Metallic steel grids are tested in combination with different Rockfon tiles and are classified in accordance with European norm EN 13501-2 and/or national norms.



Colours

Chicago Metallic grids are available in various colours from the RAL and NCS systems, which are measured following the ISO 7724-2 and ISO 7724-3 standards. The actual colours may deviate slightly from the RAL and NCS references. Chicago Metallic grids are available in a variety of finishes from matt to high gloss, with a respective average of < 5, 15 and 50 units at a 60° angle. The matt finishing is measured at an angle of 85°. See the colour legend for their average values. The gloss unit is measured in accordance with EN13523 part 2.



Corrosion resistance

Chicago Metallic products produced from hot dip galvanised steel following the Sendzimir process comply with the corrosion classes of the product standard EN 13964 (A, B, C, D). The standard systems in class B are protected with 100 g/m² zinc evenly applied on both sides. The enhanced corrosion resistance (ECR) systems and accessories in class C or D have respectively a layer of 100 g/m² and 275 g/m² zinc evenly applied on both sides and are protected with an additional layer of 20 micron paint per side.



Load bearing performance

The load bearing performance (max. kg/m² load applicable to the grid system without exceeding the allowable deflection of the individual components) is tested in accordance with the EN 13964 standard. The accumulative value of the system deflection, shown on the data sheets, does not exceed the max. deflection as given in class 1 of the standard. Special project configurations deviating from the standard module sizes mentioned in the data sheets must be calculated by Rockfon technical services.



Cleaning

All Chicago Metallic grids can be cleaned with water and a mild detergent in combination with a melamine foam sponge or microfiber cloth.

Colour legend

For colour availability of individual components, please check the assortment table above

White 001 RAL 9003	White 901 RAL 9010	White 01 White 916	Matt White 11 RAL 9003	L value: 93 Gloss: 2 at both a 60° and 85° angle
Platinum 54 RAL 7035	Alugrey 04 RAL 9006	Galvanised 00 Galvanised 69	Matt Black 88 RAL 9004	Gloss: 4.5 at 60° angle and 11.5 at 85° angle
Brushed Alu 534	High Gloss Chrome 14	Carrara 57	High Gloss Brass 16	
White 001 / White 001 (8WW) RAL 9003 / RAL 9003	Black 08 / Black 08 (8BB) RAL 9005 / RAL 9005	White 001 / Black 08 (8WB) RAL 9003 / RAL 9005	Alugrey 04 / Black 08 (8GB) RAL 9006 / RAL 9005	

Rockfon Color-all®

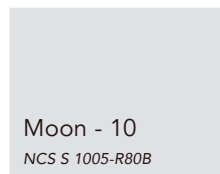
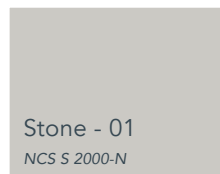
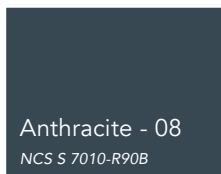
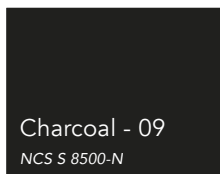
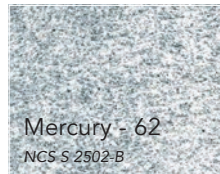
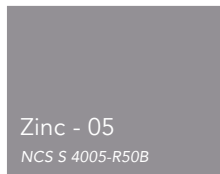
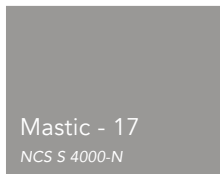
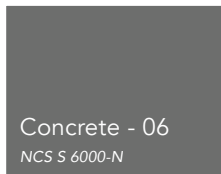
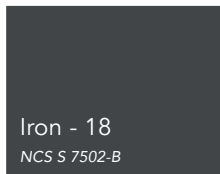
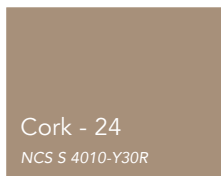
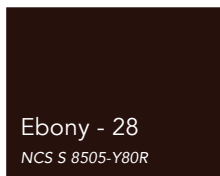
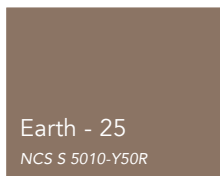
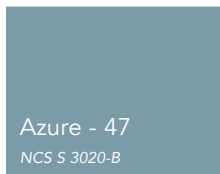
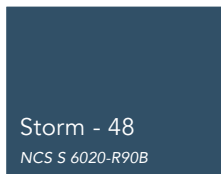
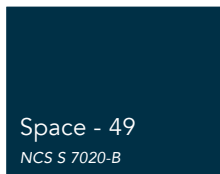
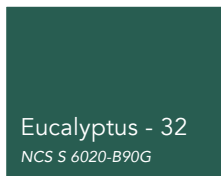
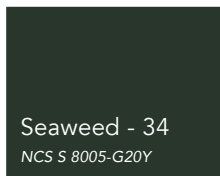
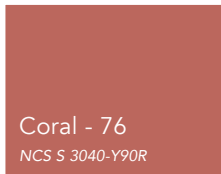
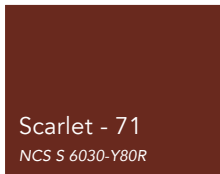
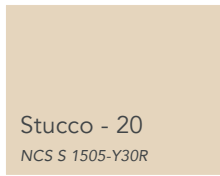

NCS codes are closest colour match. The actual colour of the Rockfon Color-all® grid may deviate slightly from printed colours due to the texture of the surface. Samples are available upon request.

06.2023 | All colour codes mentioned are based on the NCS - Natural Colour System® property of and used on license from NCS Colour AB, Stockholm 2012 or the RAL colour standard. Subject to alterations in range and product technology without prior notice. Rockfon accepts no responsibility for printing errors.

Sounds Beautiful

