

# Chicago Metallic<sup>™</sup> Primary Structure I-profiles

Datasheet

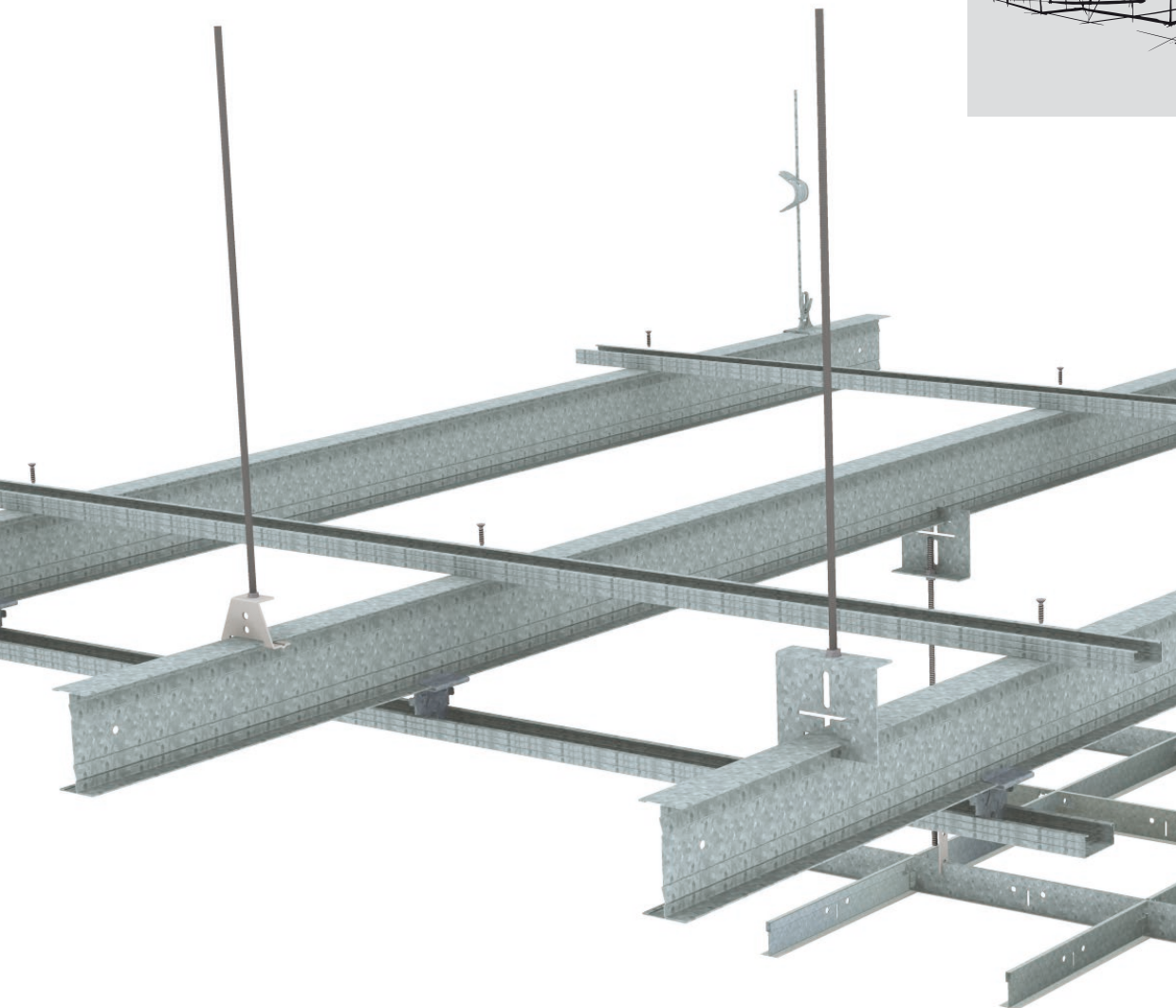

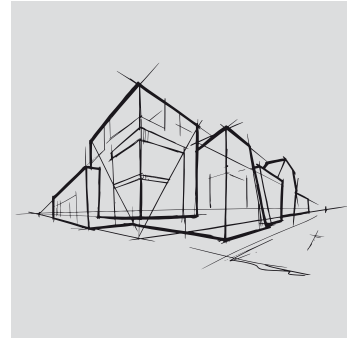





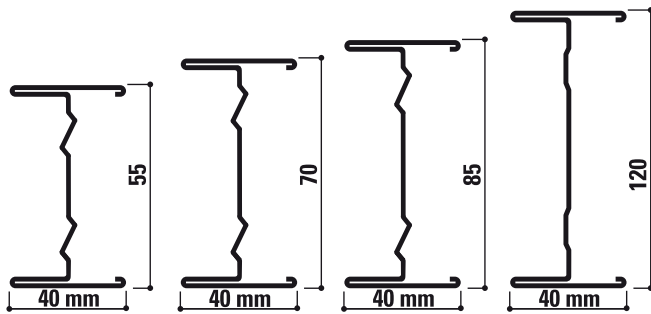

# Chicago Metallic™ Primary Structure I-profiles

- 40 mm wide I-shaped profiles for primary constructions
- Specifically designed accessories for fast and safe connections
- Available heights from 55 mm up to 120 mm to accommodate various long span distances and load requirements
- Ideal for creating primary support where traditional suspension is not possible

## Cross-section



## Assortment

Product group		Component description	Height (mm)	Length (mm)	Colour	Pcs per pack	Lm per pack	Kg per pack	Carton per pallet	Kg per pallet
I40x55		Primary I-runner 55mm	55	5000	00	5	25	19.8	40	793
I40x70		Primary I-runner 70mm	70	5000	00	5	25	21.5	40	858
I40x85		Primary I-runner 85mm	85	5000	00	4	20	18.5	40	739
I40x120		Primary I-runner 120mm	120	6500	00	1	6.5	15.1	50	15
T24 MR CL&HK		Main runner T24 Click / Hook	38	3600	Color-All, 88, 11, 001	15	54	19.5	70	1363
I40x55 LC		Length coupling for primary I-runner 55mm		150		50		3.3		
I40x70 LC		Length coupling for primary I-runner 70mm		150		50		3.6		
I40x85 LC		Length coupling for primary I-runner 85mm		150		50		4.2		
I40x120 LC		Length coupling for primary I-runner 120mm		250		25		6.7		







T24 profile is used on top of the I profiles as anti-roll bar. Maximum distance between two bars is 2m with two fixings used per connection





Product group		Component description	Height (mm)	Length (mm)	Colour	Pcs per pack	Lm per pack	Kg per pack	Carton per pallet	Kg per pallet
I40x55 WC		Cross connector for primary I-runner 55mm		100		50		8.3		
I40x70 WC		Cross connector for primary I-runner 70mm		100		50		10.3		
I40x85 WC		Cross connector for primary I-runner 85mm		100		50		11.8		
I40x120 WC		Cross connector for primary I-runner 120mm				25		6		
HC I M6 1		Hanger bracket for primary I-runner 55, 70 and 85 mm				50		5.1		
HC I M6 2		Hanger bracket for primary I-runner 100 and 120mm				50		7.1		
I40x55 HC		Holding clamp for primary I-runner 55mm				250		4.3		
I40x70 HC		Holding clamp for primary I-runner 70mm				250		4.7		
I40x85 HC		Holding clamp for primary I-runner 85 mm				100		6.2	80	
FC I T/EYE		Suspension clip for primary I-runner 55, 70, 85, 100 and 120mm				100		5.9		

T24 profile is used on top of the I profiles as anti-roll bar. Maximum distance between two bars is 2m with two fixings used per connection



## Top suspension accessories

Product group		I profile	Load bearing capacity
HC I M6 1		I40x55, I40x70, I40x85	60 kg
HC I M6 2		I40x120	160 kg
I40x55 HC		I40x55	30 kg
I40x70 HC		I40x70	35 kg
I40x85 HC		I40x85	35 kg

## Bottom suspension accessories

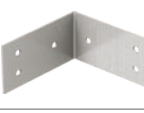
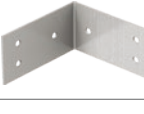
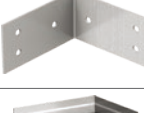

Product group		I profile	Load bearing capacity
HC I M6 1		I40x55, I40x70, I40x85, I40x120	60 kg
FC I T/EYE		I40x55, I40x70, I40x85, I40x120	40 kg

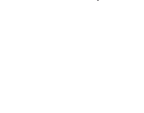
## Wall connectors

Product group		I profile	Load bearing capacity
I40x55 WC		I40x55	30 kg <sup>(1)</sup>
			60 kg <sup>(2)</sup>
I40x70 WC		I40x70	35 kg <sup>(1)</sup>
			60 kg <sup>(2)</sup>
I40x85 WC		I40x85	35 kg <sup>(1)</sup>
			60 kg <sup>(2)</sup>
I40x120 WC		I40x120	160 kg <sup>(2)</sup>

(1) with 1 wall connector, fixed to profile with 3 self drilling screws  
 (2) with 2 wall connectors, fixed to profile with 3 M6 bolt & nuts

## Position of slots and suspension holes

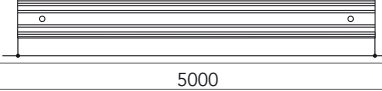
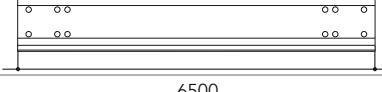
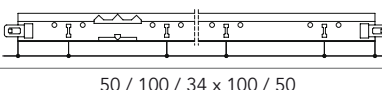
Product group	Component description	Height (mm)	Length (mm)	Slots	Distance between slots (mm)
I40x55	Primary I-runner 55mm	55	5000	0	 5000
I40x70	Primary I-runner 70mm	70	5000	0	 5000
I40x85	Primary I-runner 85mm	85	5000	0	 5000
I40x120	Primary I-runner 120mm	120	6500	0	 6500
T24 MR CL&HK	Main runner T24 Click / Hook	38	3600	36	 50 / 100 / 34 x 100 / 50

For profiles I55, I70 & I85, special lengths are available upon request.

# Performance



## Load bearing capacity

The installer must check that the admissible load per suspension point is not exceeded.

		Max. span (mm) - max. deflection = L/300													
		Max. distance between hangers in mm													
		kg/m <sup>2</sup> of ceiling													
Axis/axis distance		3	4	5	6	7	8	9	10	12	14	16	20	30	
I-section 55 mm Material thickness 0,6 mm	600	5000	5000	4600	4400	4100	4000	3800	3700	<b>3500</b>	<b>3300</b>	<b>3100</b>	<b>2900</b>	<b>2500</b>	
	700	5000	4700	4400	4100	3900	3800	3600	<b>3500</b>	<b>3300</b>	<b>3100</b>	<b>3000</b>	<b>2800</b>	<b>2400</b>	
	800	5000	4500	4200	4000	3800	3600	<b>3500</b>	<b>3300</b>	<b>3100</b>	<b>3000</b>	<b>2800</b>	<b>2600</b>	<b>2300</b>	
	900	4800	4400	4000	3800	3600	<b>3500</b>	<b>3300</b>	<b>3200</b>	<b>3000</b>	<b>2900</b>	<b>2700</b>	<b>2500</b>	<b>2000</b>	
	1000	4600	4200	3900	3700	<b>3500</b>	<b>3300</b>	<b>3200</b>	<b>3100</b>	<b>2900</b>	<b>2800</b>	<b>2600</b>	<b>2400</b>	<b>1800</b>	
	1200	4400	4000	3700	<b>3500</b>	<b>3300</b>	<b>3100</b>	<b>3000</b>	<b>2900</b>	<b>2700</b>	<b>2600</b>	<b>2500</b>	<b>2200</b>	<b>1500</b>	
	1300	4200	3900	<b>3600</b>	<b>3400</b>	<b>3200</b>	<b>3000</b>	<b>2900</b>	<b>2800</b>	<b>2700</b>	<b>2500</b>	<b>2400</b>	<b>2100</b>	<b>1400</b>	
	1400	4100	3800	<b>3500</b>	<b>3300</b>	<b>3100</b>	<b>3000</b>	<b>2900</b>	<b>2800</b>	<b>2600</b>	<b>2500</b>	<b>2400</b>	<b>2000</b>	<b>1300</b>	
	1500	4000	3700	<b>3400</b>	<b>3200</b>	<b>3000</b>	<b>2900</b>	<b>2800</b>	<b>2700</b>	<b>2500</b>	<b>2400</b>	<b>2200</b>	<b>1800</b>	<b>1200</b>	
	2000	<b>3700</b>	<b>3300</b>	<b>3100</b>	<b>2900</b>	<b>2800</b>	<b>2600</b>	<b>2500</b>	<b>2400</b>	<b>2200</b>	<b>1900</b>	<b>1700</b>	<b>1400</b>	<b>900</b>	

Top hanger = I40x55 HC / Wall connector = 1x I40X55 WC

Top hanger = HC I M6 1 / Wall connector= 2x I40x55 WC

The installer must check that the admissible load per suspension point is not exceeded.

		Max. span (mm) - max. deflection = L/300													
		Max. distance between hangers in mm													
		kg/m <sup>2</sup> of ceiling													
Axis/axis distance		3	4	5	6	7	8	9	10	12	14	16	20	30	
I-section 70 mm Material thickness 0,6 mm	600	5000	5000	5000	5000	4900	4700	4500	4400	<b>4100</b>	<b>3900</b>	<b>3700</b>	<b>3500</b>	<b>3000</b>	
	700	5000	5000	5000	4900	4700	4500	<b>4300</b>	<b>4200</b>	<b>3900</b>	<b>3700</b>	<b>3500</b>	<b>3300</b>	<b>2600</b>	
	800	5000	5000	5000	4700	4500	<b>4300</b>	<b>4100</b>	<b>4000</b>	<b>3700</b>	<b>3500</b>	<b>3400</b>	<b>3100</b>	<b>2300</b>	
	900	5000	5000	4800	4500	<b>4300</b>	<b>4100</b>	<b>4000</b>	<b>3800</b>	<b>3600</b>	<b>3400</b>	<b>3300</b>	<b>2900</b>	<b>2000</b>	
	1000	5000	5000	4700	<b>4400</b>	<b>4200</b>	<b>4000</b>	<b>3800</b>	<b>3700</b>	<b>3500</b>	<b>3300</b>	<b>3100</b>	<b>2700</b>	<b>1800</b>	
	1100	5000	4900	4500	<b>4200</b>	<b>4000</b>	<b>3800</b>	<b>3700</b>	<b>3600</b>	<b>3400</b>	<b>3200</b>	<b>3000</b>	<b>2400</b>	<b>1700</b>	
	1200	5000	4700	<b>4400</b>	<b>4100</b>	<b>3900</b>	<b>3700</b>	<b>3600</b>	<b>3500</b>	<b>3300</b>	<b>3100</b>	<b>2800</b>	<b>2200</b>	<b>1500</b>	
	1300	5000	4600	<b>4300</b>	<b>4000</b>	<b>3800</b>	<b>3600</b>	<b>3500</b>	<b>3400</b>	<b>3200</b>	<b>2900</b>	<b>2600</b>	<b>2100</b>	<b>1400</b>	
	1400	4900	<b>4500</b>	<b>4200</b>	<b>3900</b>	<b>3700</b>	<b>3500</b>	<b>3400</b>	<b>3300</b>	<b>3100</b>	<b>2700</b>	<b>2400</b>	<b>1900</b>	<b>1300</b>	
	1500	4800	<b>4400</b>	<b>4100</b>	<b>3800</b>	<b>3600</b>	<b>3500</b>	<b>3300</b>	<b>3200</b>	<b>2900</b>	<b>2500</b>	<b>2200</b>	<b>1800</b>	<b>1200</b>	
	2000	<b>4400</b>	<b>4000</b>	<b>3700</b>	<b>3500</b>	<b>3300</b>	<b>3100</b>	<b>2900</b>	<b>2600</b>	<b>2200</b>	<b>1900</b>	<b>1700</b>	<b>1400</b>	<b>900</b>	

Top hanger = I40x70 HC / Wall connector= 1x I40X70 WC

Top hanger = HC I M6 1 / Wall connector= 2x I40x70 WC

The installer must check that the admissible load per suspension point is not exceeded.

		Max. span (mm) - max. deflection = L/300													
		Max. distance between hangers in mm													
		kg/m <sup>2</sup> of ceiling													
Axis/axis distance		3	4	5	6	7	8	9	10	12	14	16	20	30	
I-section 85 mm Material thickness 0,6 mm	600	5000	5000	5000	5000	5000	5000	5000	5000	5000	4700	4500	4200	2900	
	700	5000	5000	5000	5000	5000	5000	5000	5000	4700	4500	4300	3700	2500	
	800	5000	5000	5000	5000	5000	5000	5000	4800	4500	4300	4000	3300	2200	
	900	5000	5000	5000	5000	5000	5000	4800	4600	4300	4000	3600	2900	2000	
	1000	5000	5000	5000	5000	5000	4800	4600	4400	4200	3700	3300	2600	1800	
	1100	5000	5000	5000	5000	4800	4600	4500	4300	3900	3400	3000	2400	1700	
	1200	5000	5000	5000	5000	4700	4500	4300	4200	3600	3100	2700	2200	1500	
	1300	5000	5000	5000	4800	4600	4400	4200	3900	3300	2900	2500	2100	1400	
	1400	5000	5000	5000	4700	4500	4300	4000	3600	3100	2700	2300	1900	1300	
	1500	5000	5000	4900	4600	4400	4100	3800	3400	2900	2500	2200	1800	1200	
	2000	5000	4800	4400	4100	3600	3200	2900	2600	2200	1900	1700	1400	900	

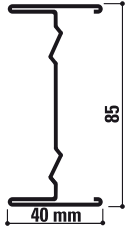

Top hanger = I40x85 HC / Wall connector= 1x I40x85 WC  
 Top hanger = HC I M6 1 / Wall connector= 2x I40x85 WC

The installer must check that the admissible load per suspension point is not exceeded.

		Max. span (mm) - max. deflection = L/300													
		Max. distance between hangers in mm													
		kg/m <sup>2</sup> of ceiling													
Axis/axis distance		3	4	5	6	7	8	9	10	12	14	16	20	30	
I-section 120 mm	600	6500	6500	6500	6500	6500	6500	6500	6500	6500	6500	6500	6500	5900	
	700	6500	6500	6500	6500	6500	6500	6500	6500	6500	6500	6500	6500	5600	
	800	6500	6500	6500	6500	6500	6500	6500	6500	6500	6500	6500	6200	5400	
	900	6500	6500	6500	6500	6500	6500	6500	6500	6500	6500	6400	5900	5000	
	1000	6500	6500	6500	6500	6500	6500	6500	6500	6500	6500	6200	5700	4500	
	1100	6500	6500	6500	6500	6500	6500	6500	6500	6500	6200	6000	5500	4200	
	1200	6500	6500	6500	6500	6500	6500	6500	6500	6400	6100	5800	5400	3900	
	1300	6500	6500	6500	6500	6500	6500	6500	6500	6200	5900	5600	5100	3600	
	1400	6500	6500	6500	6500	6500	6500	6500	6500	6100	5800	5500	4800	3300	
	1500	6500	6500	6500	6500	6500	6500	6500	6000	5900	5600	5400	4500	3100	
	2000	6500	6500	6500	6500	6500	6200	5900	5700	5400	4800	4200	3500	2400	

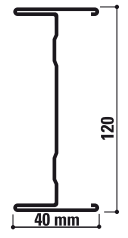

Top hanger = HC I M6 2 / Wall connector= 2x I40x120 WC

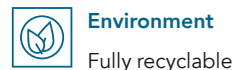
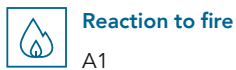

# Understanding the performance of Chicago Metallic™ grids and accessories



## Reaction to fire

Reaction to fire is classified in accordance with EN 13501-1. Chicago Metallic steel grids and accessories are non-combustible.



## Fire resistance

A range of Chicago Metallic steel grids are tested in combination with different Rockfon tiles and are classified in accordance with European norm EN 13501-2 and/or national norms.



## Colours

Chicago Metallic grids are available in various colours from the RAL and NCS systems, which are measured following the ISO 7724-2 and ISO 7724-3 standards. The actual colours may deviate slightly from the RAL and NCS references. Chicago Metallic grids are available in a variety of finishes from matt to high gloss, with a respective average of < 5, 15 and 50 units at a 60° angle. The matt finishing is measured at an angle of 85°. See the colour legend for their average values. The gloss unit is measured in accordance with EN13523 part 2.



## Corrosion resistance

Chicago Metallic products produced from hot dip galvanised steel following the Sendzimir process comply with the corrosion classes of the product standard EN 13964 (A, B, C, D). The standard systems in class B are protected with 100 g/m<sup>2</sup> zinc evenly applied on both sides. The enhanced corrosion resistance (ECR) systems and accessories in class C or D have respectively a layer of 100 g/m<sup>2</sup> and 275 g/m<sup>2</sup> zinc evenly applied on both sides and are protected with an additional layer of 20 micron paint per side.



## Load bearing performance

The load bearing performance (max. kg/m<sup>2</sup> load applicable to the grid system without exceeding the allowable deflection of the individual components) is tested in accordance with the EN 13964 standard. The accumulative value of the system deflection, shown on the data sheets, does not exceed the max. deflection as given in class 1 of the standard. Special project configurations deviating from the standard module sizes mentioned in the data sheets must be calculated by Rockfon technical services.



## Cleaning

All Chicago Metallic grids can be cleaned with water and a mild detergent in combination with a melamine foam sponge or microfiber cloth.

## Colour legend

For colour availability of individual components, please check the assortment table above

White 001 RAL 9003	White 901 RAL 9010	White 01 White 916	Matt White 11 RAL 9003	L value: 93 Gloss: 2 at both a 60° and 85° angle
Platinum 54 RAL 7035	Alugrey 04 RAL 9006	Galvanised 00 Galvanised 69	Matt Black 88 RAL 9004	Gloss: 4.5 at 60° angle and 11.5 at 85° angle
Brushed Alu 534	High Gloss Chrome 14	Carrara 57	High Gloss Brass 16	
White 001 / White 001 (8WW) RAL 9003 / RAL 9003	Black 08 / Black 08 (8BB) RAL 9005 / RAL 9005	White 001 / Black 08 (8WB) RAL 9003 / RAL 9005	Alugrey 04 / Black 08 (8GB) RAL 9006 / RAL 9005	

# Rockfon Color-all®

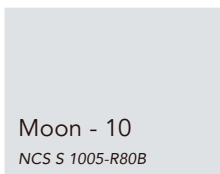
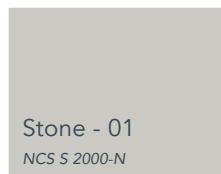
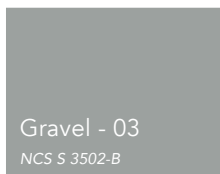
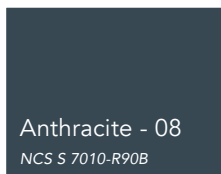
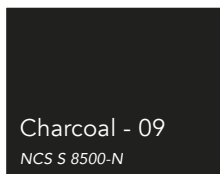
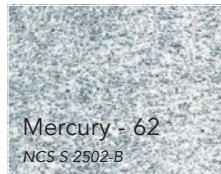
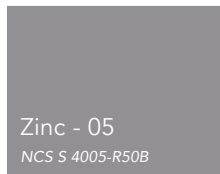
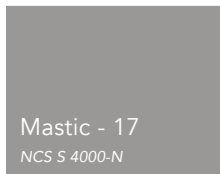
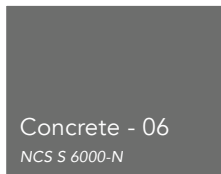
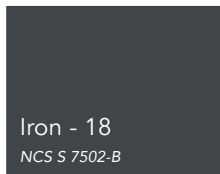
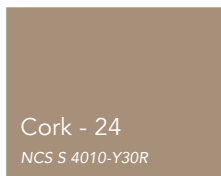
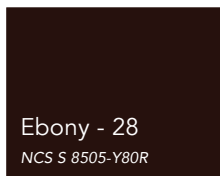
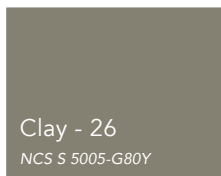
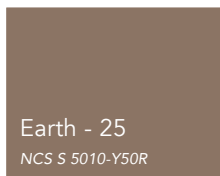
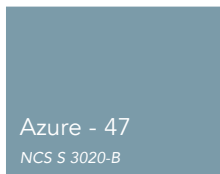
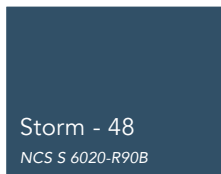
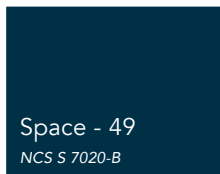
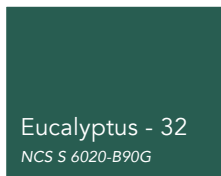
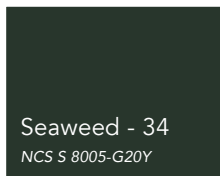
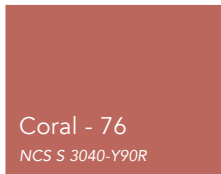
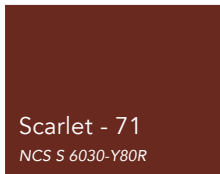
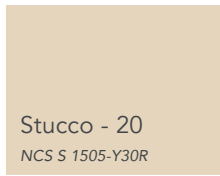

NCS codes are closest colour match. The actual colour of the Rockfon Color-all® grid may deviate slightly from printed colours due to the texture of the surface. Samples are available upon request.



Rockfon® is a registered trademark  
of the ROCKWOOL Group.

 [linkedin.com/company/Rockfon-as](https://www.linkedin.com/company/Rockfon-as)

 [pinterest.com/Rockfon](https://www.pinterest.com/Rockfon)

 [youtube.com/RockfonOfficial](https://www.youtube.com/RockfonOfficial)

 [facebook.com/RockfonOfficial](https://www.facebook.com/RockfonOfficial)

 [instagram.com/Rockfon\\_Official](https://www.instagram.com/Rockfon_Official)

## Sounds Beautiful

03/2022 | All colour codes mentioned are based on the NCS - Natural Colour System® property of and used on license from NCS Colour AB, Stockholm 2012 or the RAL colour standard. Subject to alterations in range and product technology without prior notice. Rockfon accepts no responsibility for printing errors.



**Rockfon**  
ROCKWOOL Limited T/A Rockfon  
14th Floor, Chiswick Tower, 389 Chiswick High Road,  
London W4 4AL  
Tel: +44 (0) 208 222 7457  
[www.rockfon.co.uk](http://www.rockfon.co.uk)