

INSTALLATION GUIDE

Rockfon® System VertiQ® C Wall™

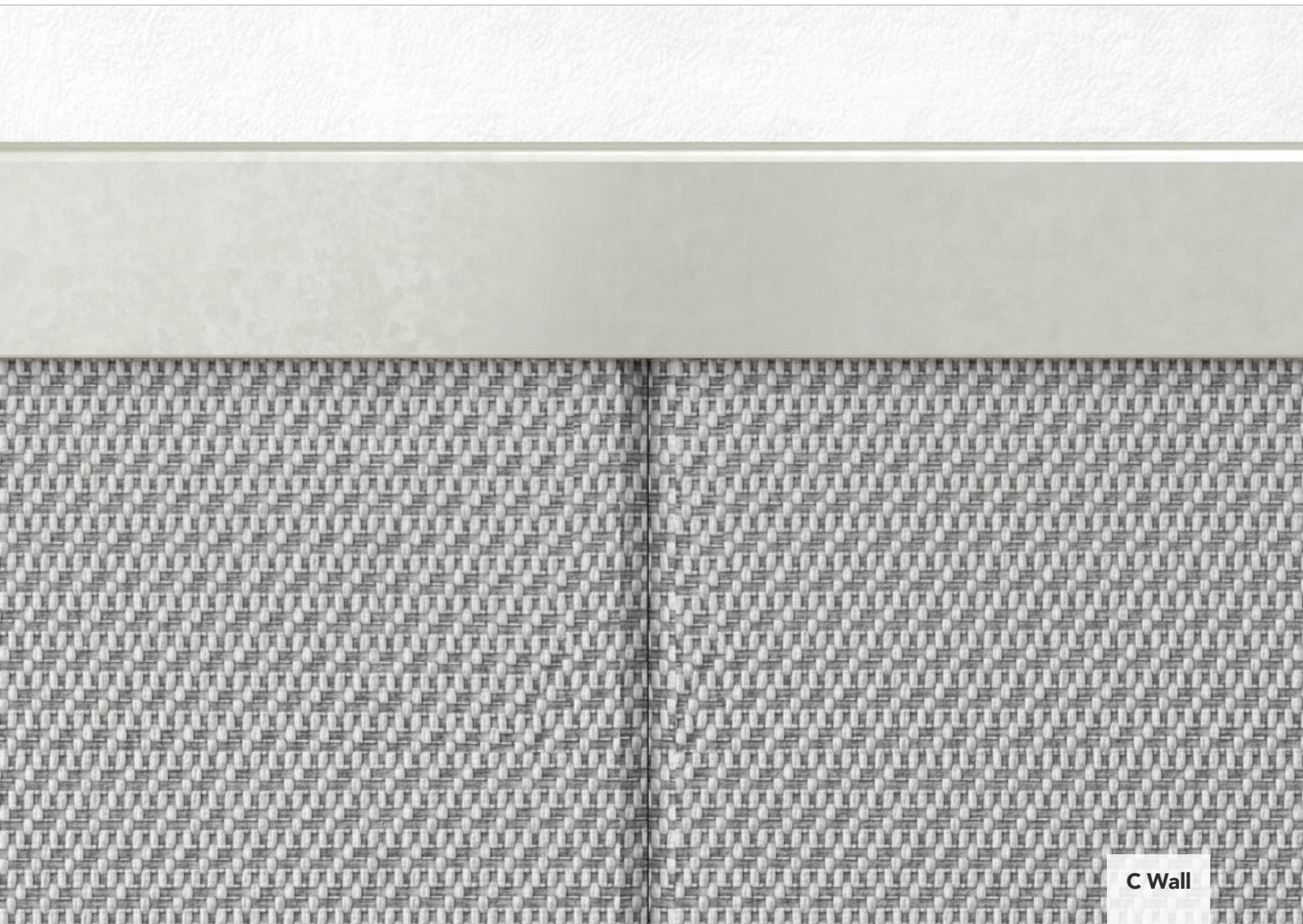

Concealed wall system

- Wall lining element for acoustic corrections
- Available in 4 standard colours
- Specifically developed system making installation fast and easy
- Every single panel is demountable

Sounds Beautiful

Description

Rockfon System VertiQ C Wall consists of 40 mm thick Rockfon® VertiQ® C Wall panels. It is installed using specially designed fixing brackets, anodized aluminium perimeter cover profiles and rounded corner connectors for higher safety.

Rockfon VertiQ C Wall panels have an elegant and durable woven surface that comes in 4 colours (white, grey, light grey and black) and which are easily demountable.

Restrictions

Rockfon System VertiQ C Wall has been tested for impact resistance in accordance with DIN 18032 part 3 and fulfils the demands for handball ball throwing (restrictedly safe against ball throwing).

The impact resistance of the panels is high, however, it is not recommended for use in areas which are subjected to continuous high levels of impact.

The woven surface of Rockfon VertiQ provides enhanced resistance to perforation.



Elegant and safe rounded corner detail in aluminium.



Nice and neat concealed connection between the panels and anodized aluminium perimeter cover profile.

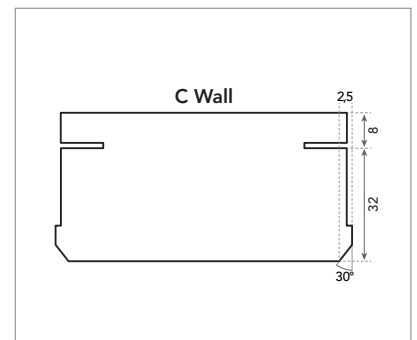

C-edge.

System components and installation guide

The quantities required of the different components depend on the size of the surface area.
Here is an example with 4 Rockfon VertiQ C Wall panels in width and 1 panel in height (2400 x 600):

Tile		Cover profiles + Accessories					
		1	2	3	4	5	6
-		Perimeter cover profile L = 2380 mm	Fixing bracket	External corner	Internal corner	Connection plate	Locking screw
Dimension (mm)	Consumption/m ²						
2400 x 600	4 pcs/m ²	9,60 lm/m ²	20 pcs	4 pcs/m ²	-	6 pcs	8 pcs

Panel – C-edge

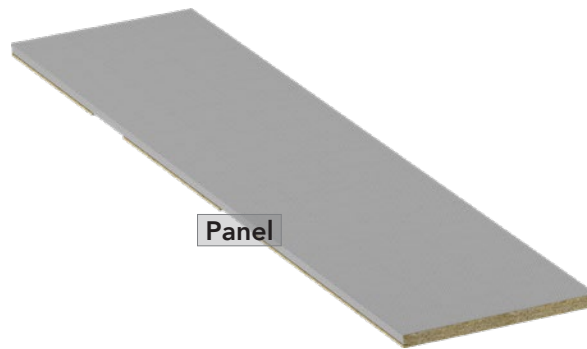

Cover profiles + Accessories

1 Perimeter cover profile



2 Fixing bracket



3 External corner



4 Internal corner



5 Connection plate



6 Locking screw



Performance



Corrosion resistance

Class B (EN13964)



Demountability

Panels installed in Rockfon System VertiQ C Wall are fully demountable, using a demountable tool.



Impact resistance

Rockfon System VertiQ C Wall has been tested for impact resistance in accordance with DIN 18032 part 3 and fulfils the demands for handball ball throwing (restrictedly safe against ball throwing). The impact resistance of Rockfon VertiQ is high, however, it is not recommended for use in areas which are subjected to continuous high levels of impact.

Compatible Panels Overview

Only Rockfon VertiQ Wall panels available in dimensions mentioned below can be installed in Rockfon System VertiQ C Wall.

		Dimension (mm)
Panels	Thickness (mm)	2400 x 600
Rockfon® VertiQ® C	40	•

Please contact Rockfon for other dimensions.

Installation

Layout

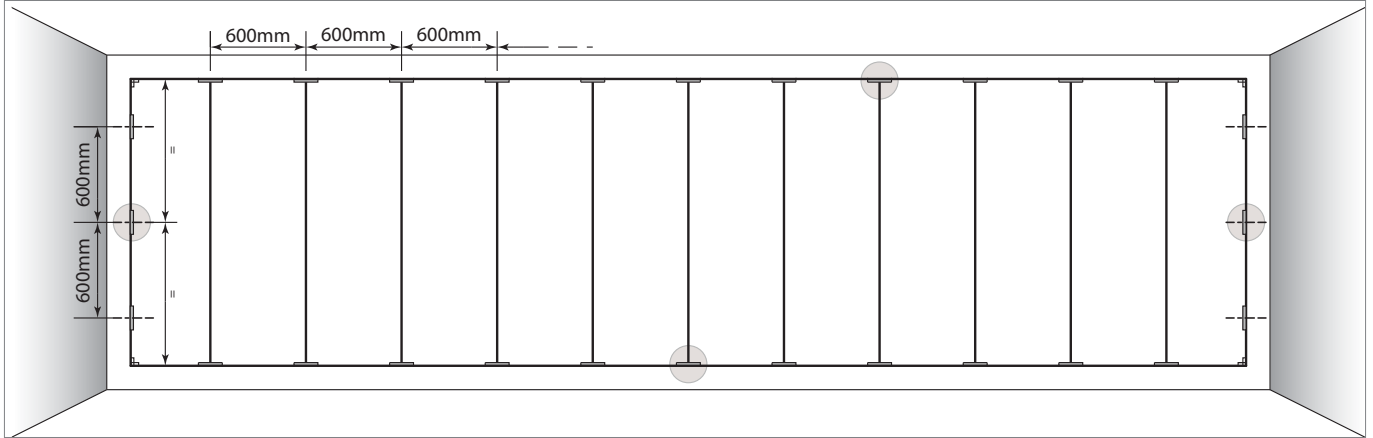

Installation requirements

Ensure that the walls are smooth and even. For installation "directly on the floor", ensure that the floor is horizontal and flat. Do any smoothing/levelling work before installation of the system. If necessary, install a framework to compensate for uneven walls. The walls upon which the wall panels are to be installed must be clean and dry.

For off-floor installations, consideration should be given to using a scuff-resistant skirting or base support between the floor and bottom perimeter trim. This will reduce the likelihood of damage from shoes, luggage, vacuum cleaners or other floor-level risks. Use mounting screws, methods and amount of fixing points appropriate for the wall material.

Check the rectangular mounting surface, the diagonals must be the same length:

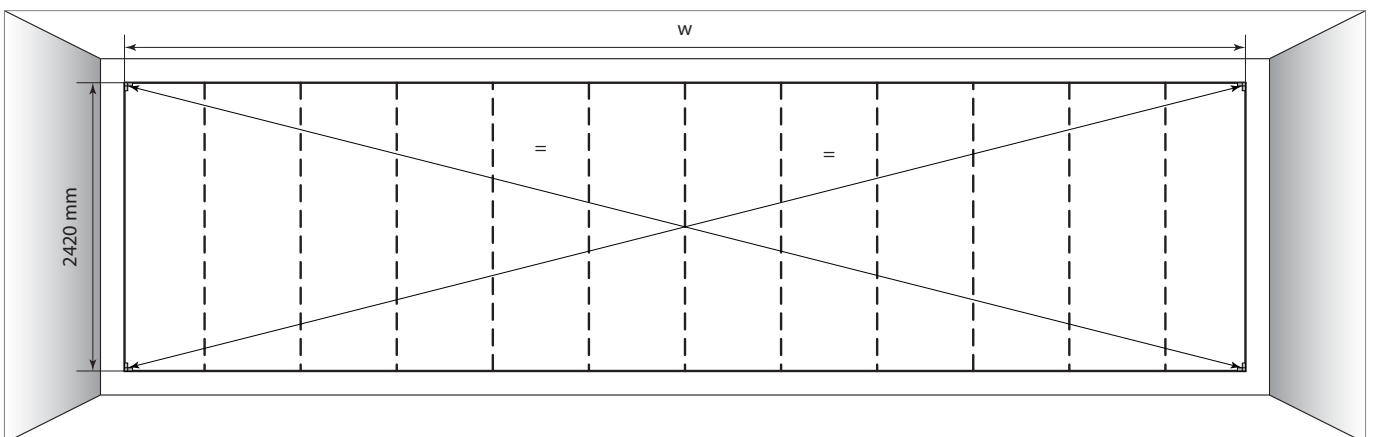

Installation steps

1 Laying out.

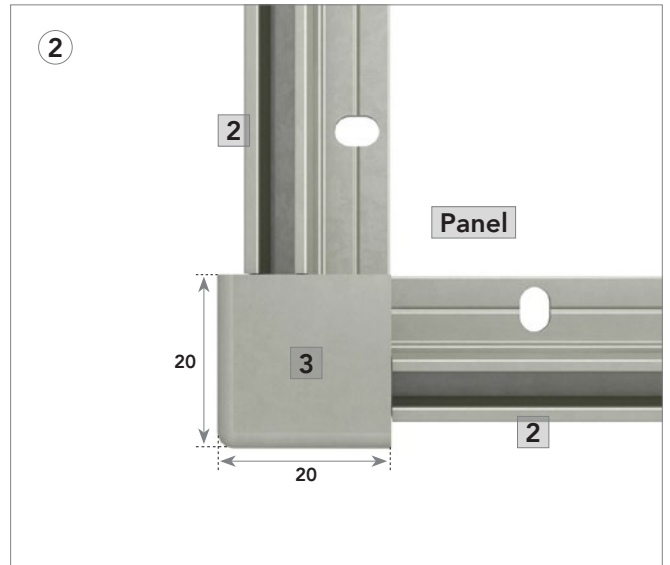
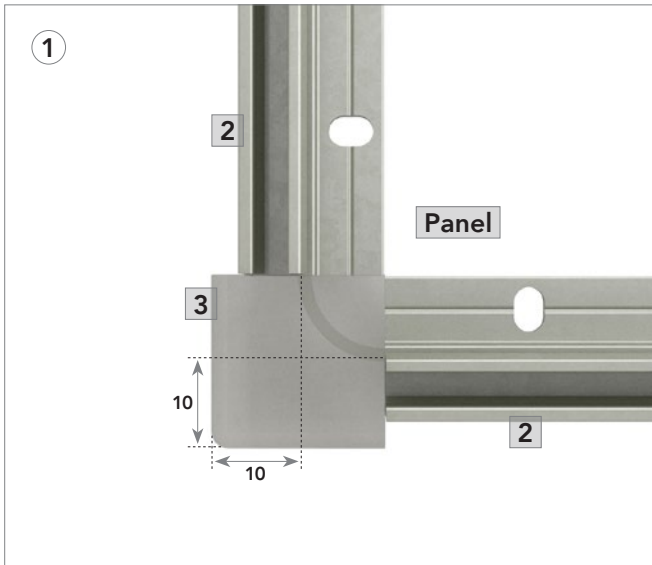
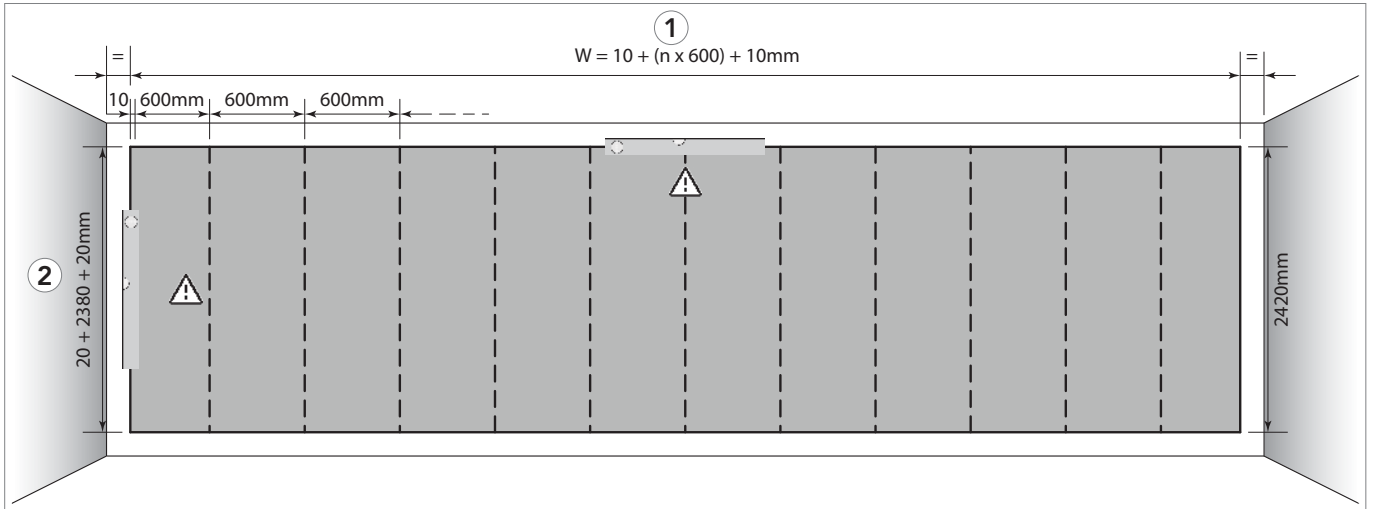

2 Assemble and install external corner connectors and two fixing brackets in each corner.

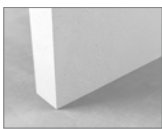
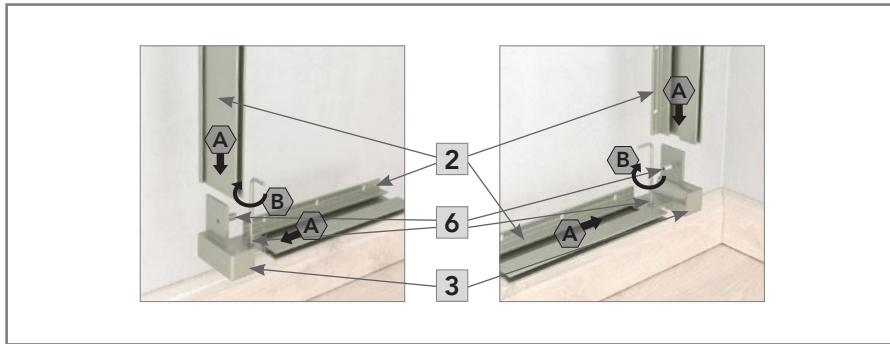
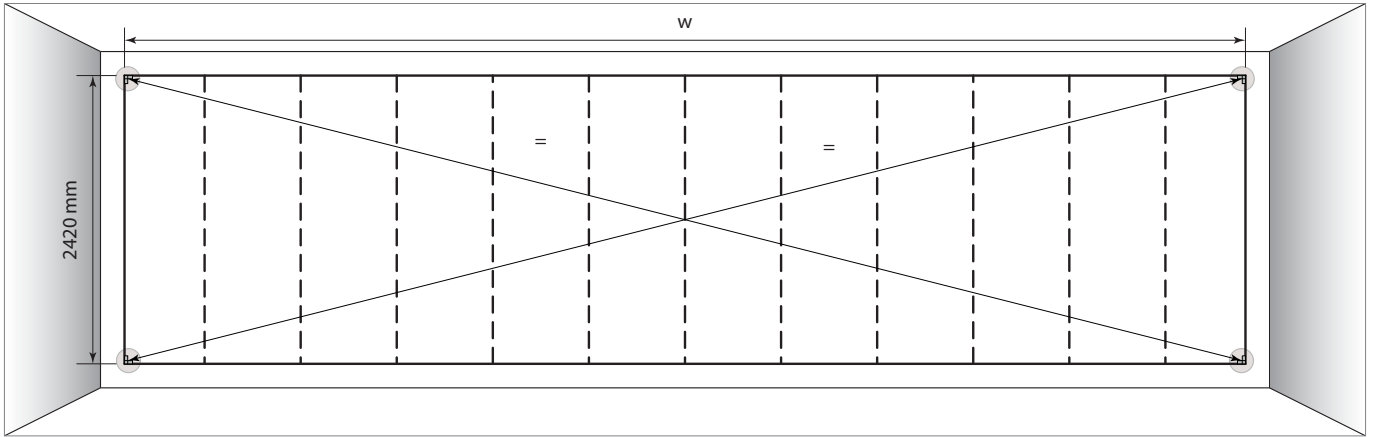

Note! Check the rectangular mounting surface: the diagonals must be the same length.

Note! Use the relevant methods, mounting screws and number of fixing points appropriate for the wall material.

3 Check the components and install all remaining fixing brackets.

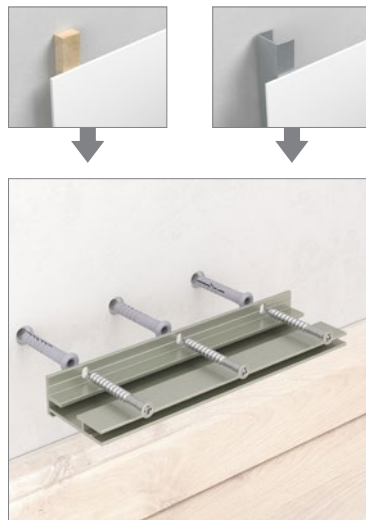
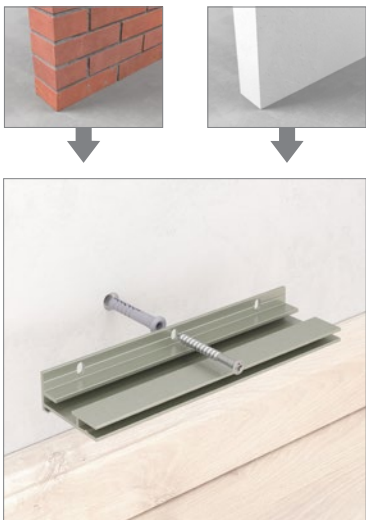
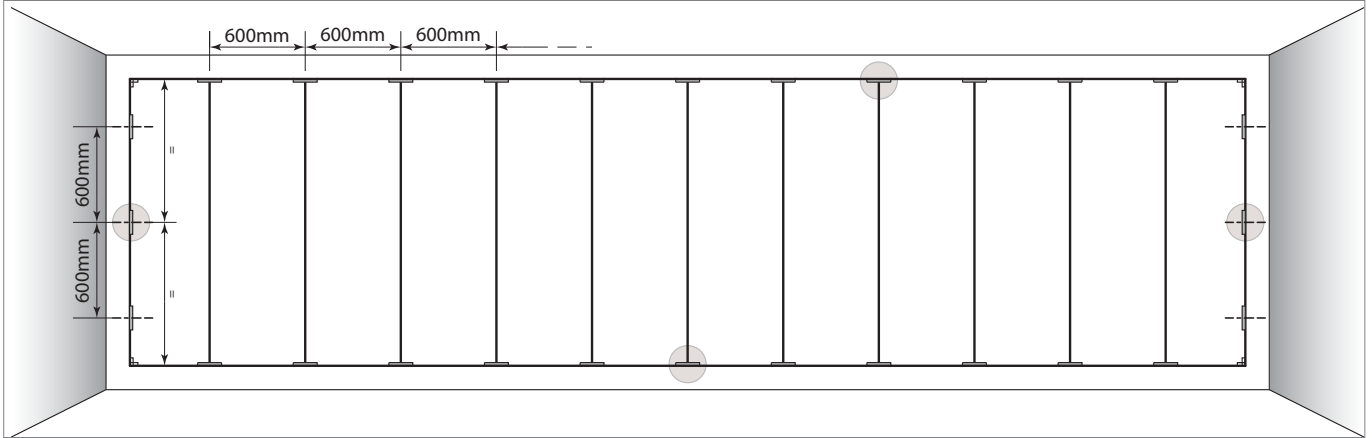

Note! Use the relevant methods, mounting screws and number of fixing points appropriate for the wall material.

4 Install all perimeter cover profiles into their fixing brackets and ensure alignment.

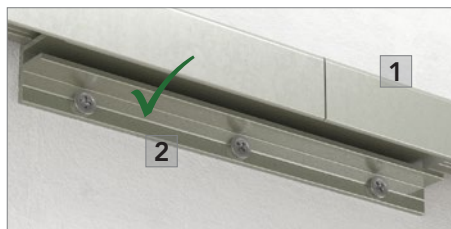
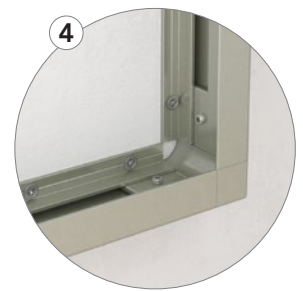
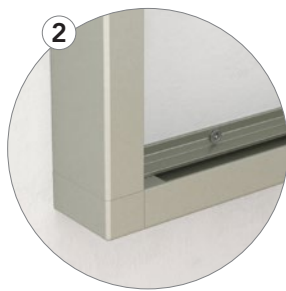
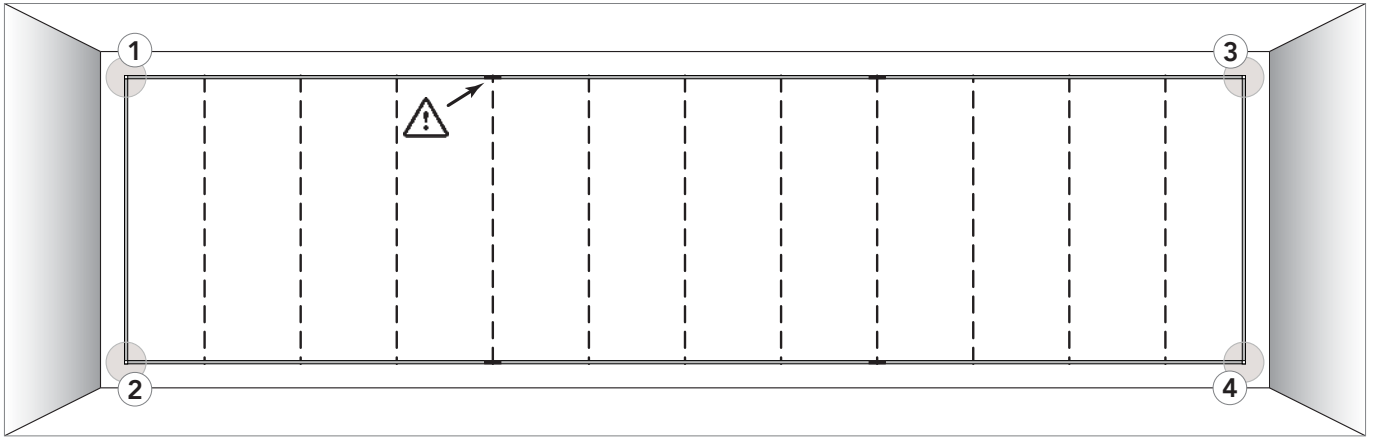

Note! Fix all the cover profiles into their fixing brackets to ensure that the grid is precise enough.

When necessary, correct the grid accordingly. When OK, demount side and bottom cover profiles but not the top cover profiles - they remain fixed in their fixing brackets. The grid is now ready for mounting the wall panels.

 Always ensure there is a fixing bracket at the joint between adjoining perimeter cover profiles.

5 Install the first wall panel to the left.

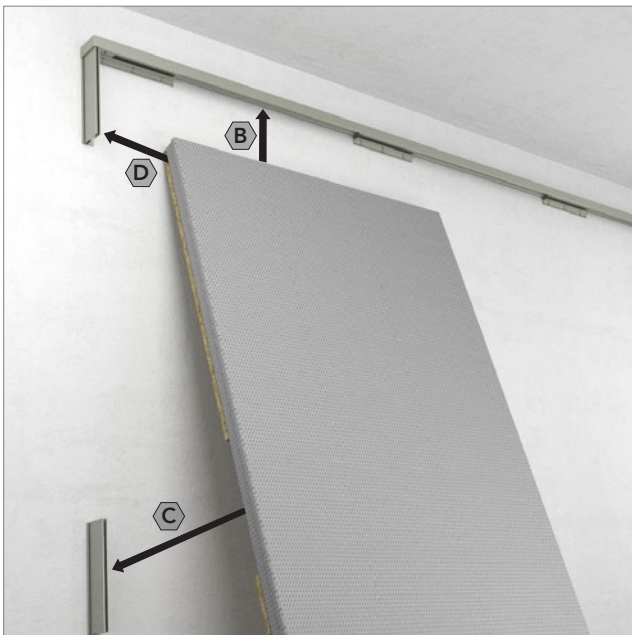
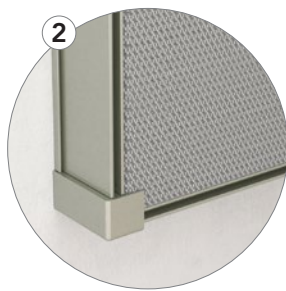
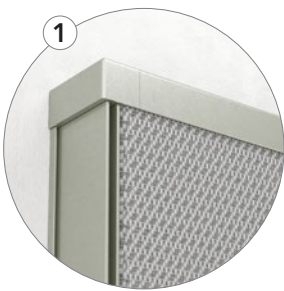
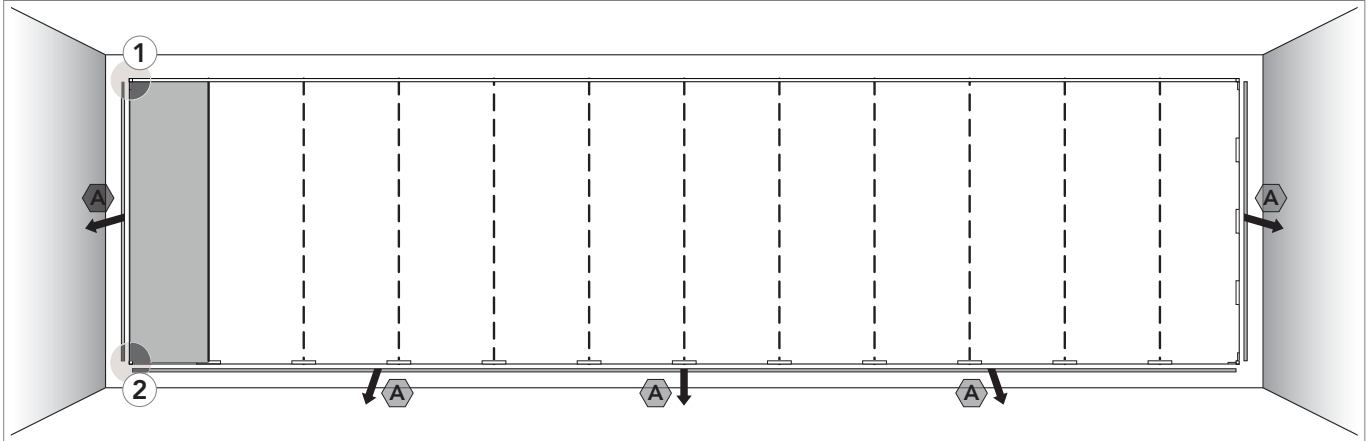

6 Install all the wall panels, except for the next-to-last one.

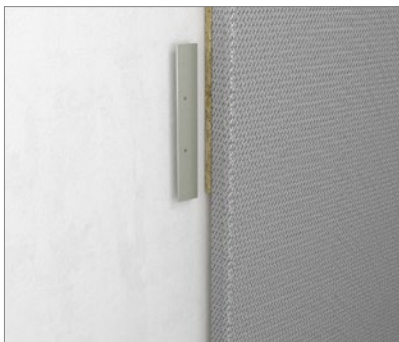
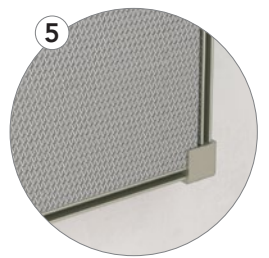
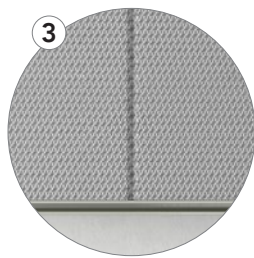
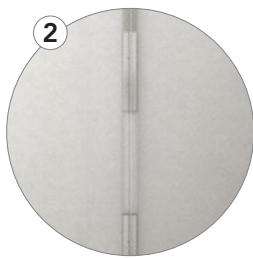
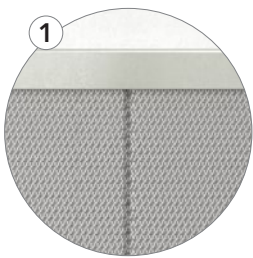
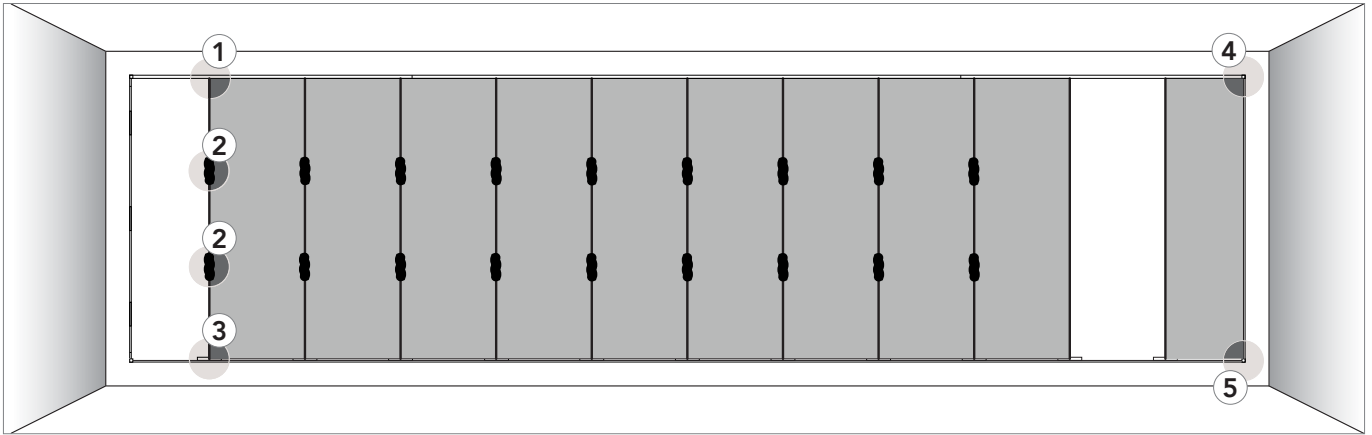

Note! To achieve a level and solid panel construction across the entire wall, connection plates should be used to lock adjoining panels together. Insert a connection plate into the groove just above the recess at the back edge of the panel. Use two connection plates per panel. This will allow you to demount every single panel independently.

7 Install the final panel on the wall.

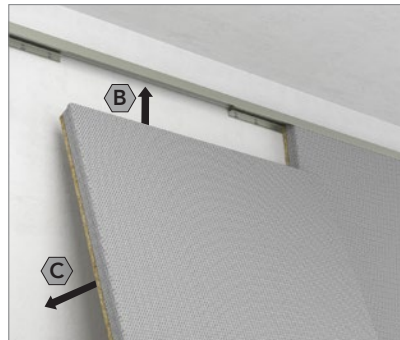
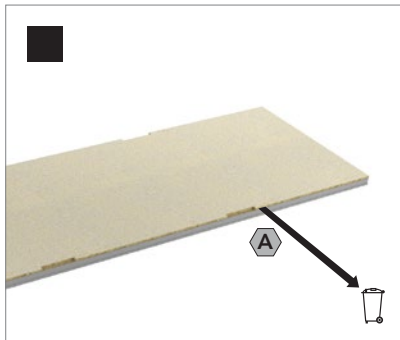
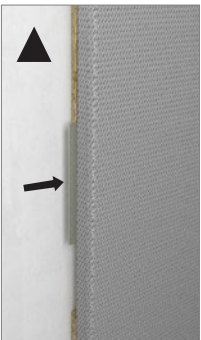
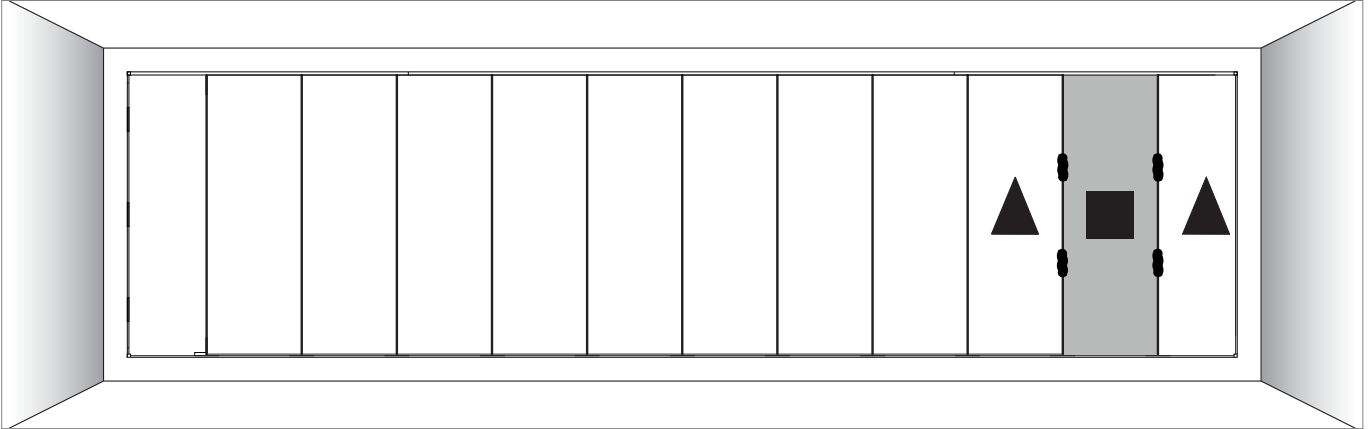

Note! At every recess (4 x), use a knife to cut out 50-60 mm more space on the top side of each recess.

Note! At the end, use a knife (plaster knife) to lift up the 4 connection plates to achieve perfect locking.

8 Install all the perimeter cover profiles to the left, right and bottom.

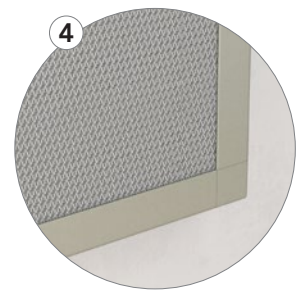
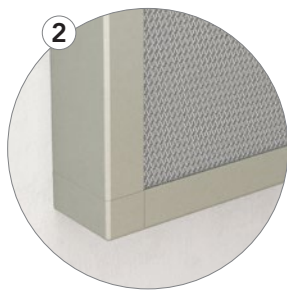
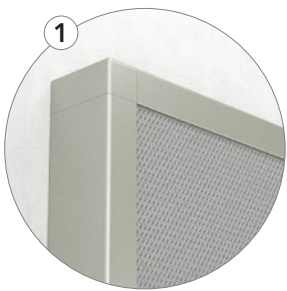
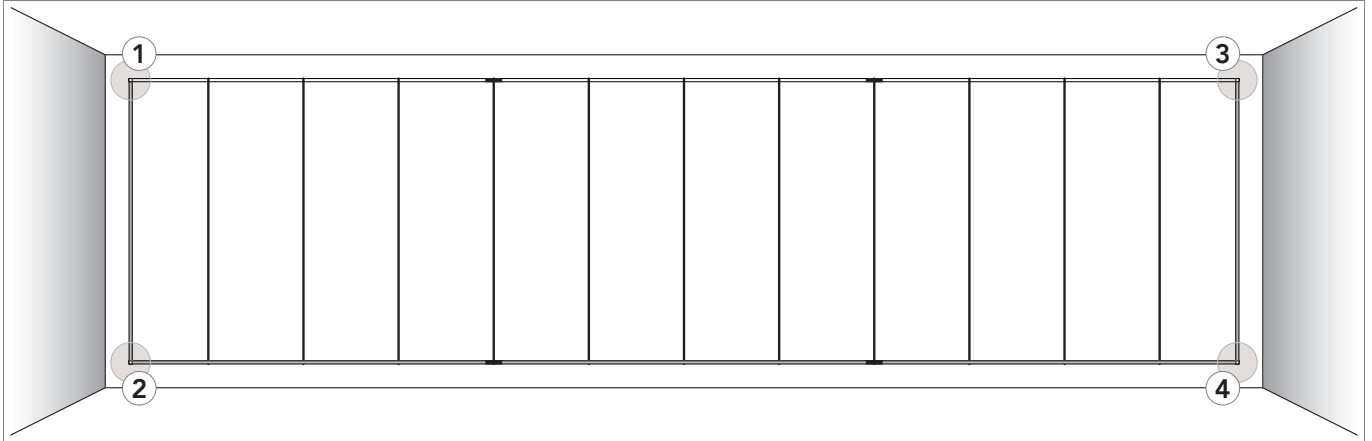

Minimum installation depth (mm)

Panels mounted in Rockfon System VertiQ C Wall are fully demountable.

The installation depth is defined as the distance from the front side of the panel to the wall substrate. D represents the exact installation depth that allows for easy panel installation and demounting.

The installation depth D is the minimum installation depth for easy panel installation and demountability.

Thickness	Dimension	D
mm		
40	2400 x 600	43

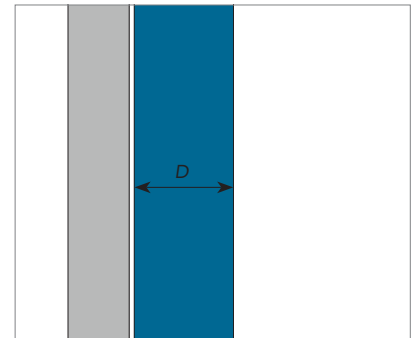

General installation recommendations

Panels

It is recommended to use clean nitrile or PU coated gloves when mounting Rockfon panels in order to avoid finger prints and pollution of the surface.

For an optimised work environment, we recommend installers always observe common work practices and follow the installation advice as shown on our packaging.

Cutting is made easily with a sharp knife. All offcuts and holes must be treated according to local Building Regulations.

Note! Certain smooth matt surfaces are directional. To ensure consistency of the finished ceiling, it is important that all panels are mounted in one direction, as indicated by the arrow printed on the back of each panel.

Tools

Rockfon has developed specific tools that are available on cee.rockfon.international

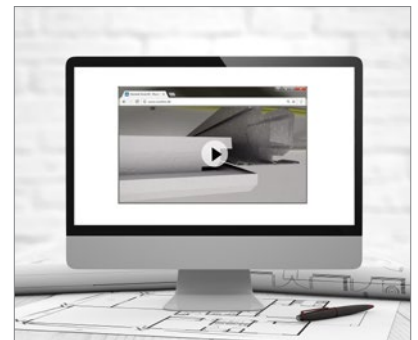

Visit our video library to see our collection of Rockfon system installation videos.



Visit our online CAD Library or BIM portal to assist you in your project design.



Generate specification texts for our products on our website.

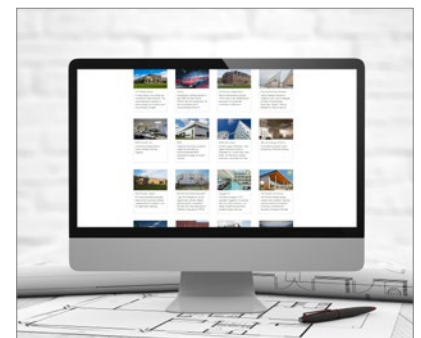

Explore our vast library of reference projects on our website.

Sounds Beautiful

