

Rockfon® System Olympia^{Plus} A Impact 1A™

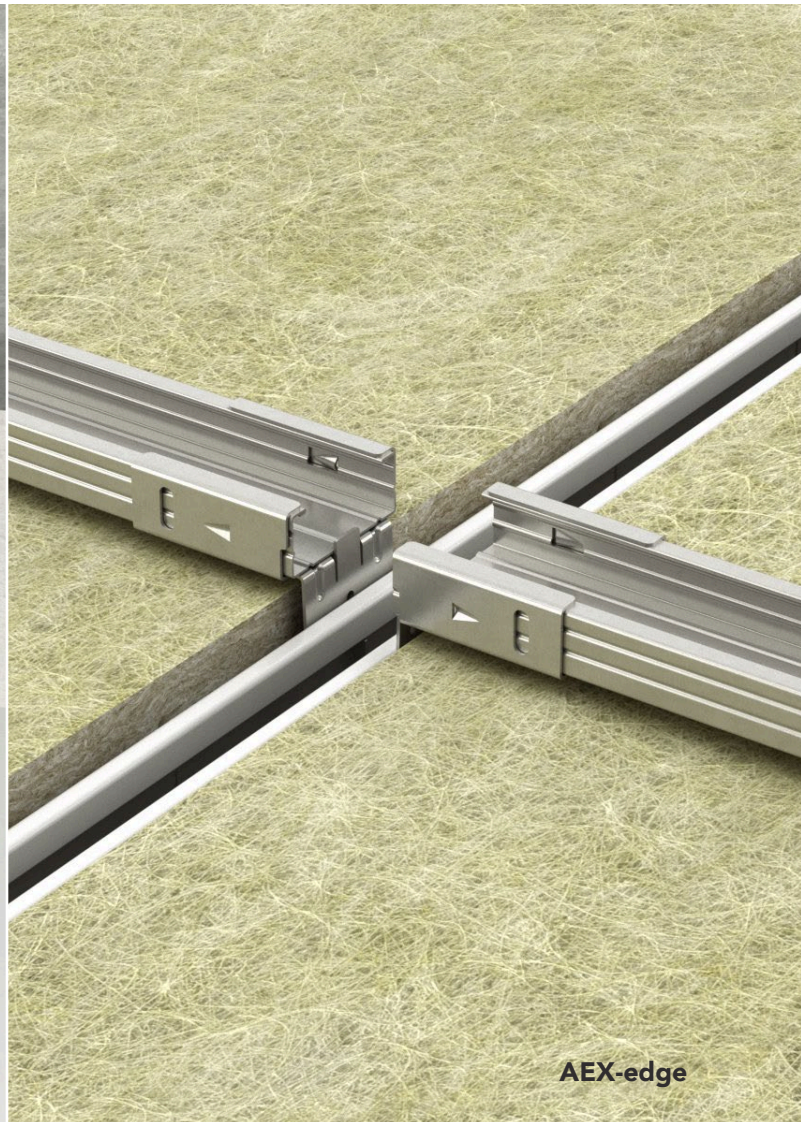

Ceiling systems for special applications Impact resistance

- Ideal combination of good acoustics and impact resistance for sports halls
- Highest impact resistance Class 1A (EN13964-Annex D)
- Aesthetically appealing white surface
- Every single tile is demountable for easy and fast access to installations

Description

This high impact resistance system consists of the Chicago Metallic 50 mm Bandraster 3050 grid with a specially designed H-shaped hold-down frame holding Rockfon impact resistant 40 mm tiles Rockfon® Boxer™ or Rockfon® Samson™ in place when exposed to ball impact. The grid profiles are made from galvanized Z100 steel, they are painted white as standard. The system is intended to be suspended from soffits using nonius hangers.

Bandraster cross connectors should be placed into cross tees and then hooked onto and mechanically fastened to main runners using self tapping screws. At walls, the ends of the main runners and cross tees should be connected to the wall using bandraster wall connectors. The hold-down frame can be fitted after the Rockfon Boxer and Rockfon Samson tile has been installed.

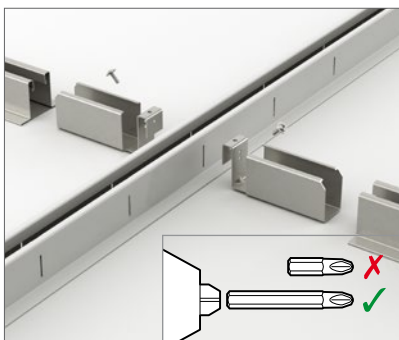
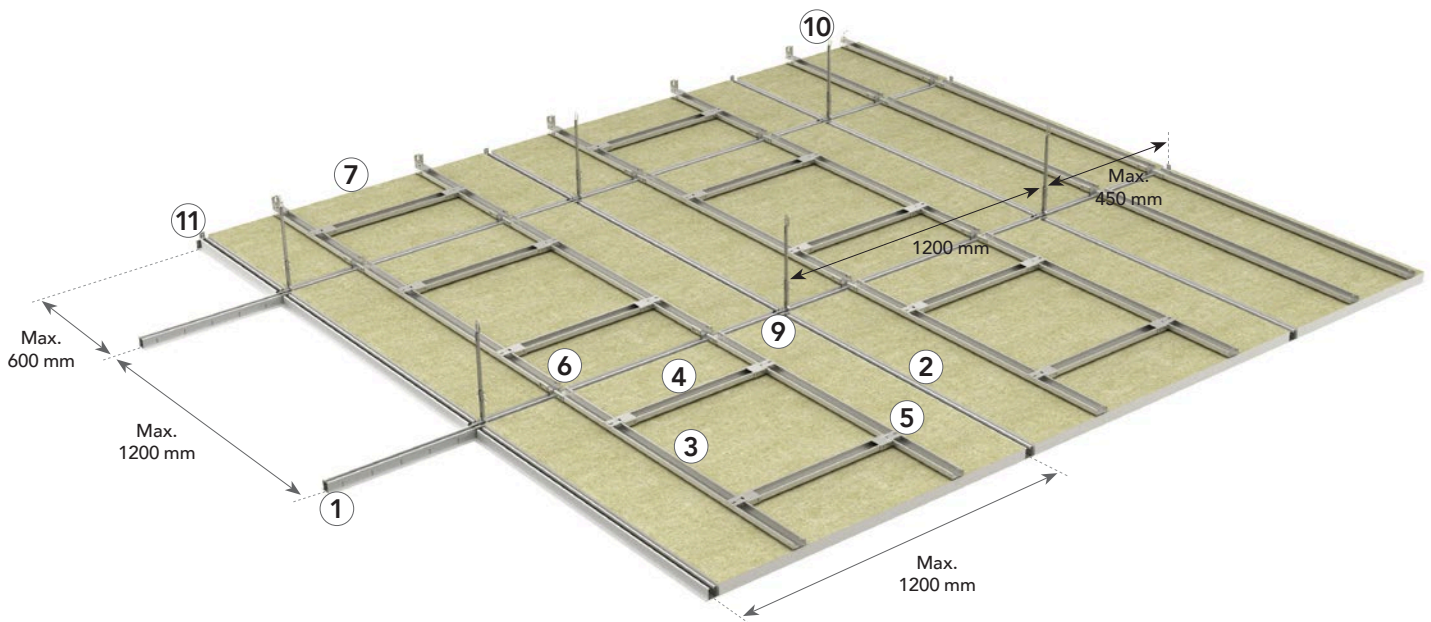

Connecting a cross tee to a main runner.

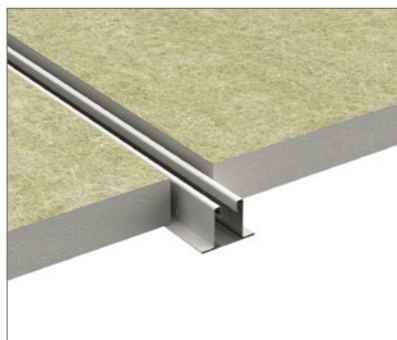

Installing Rockfon Boxer and Rockfon Samson.

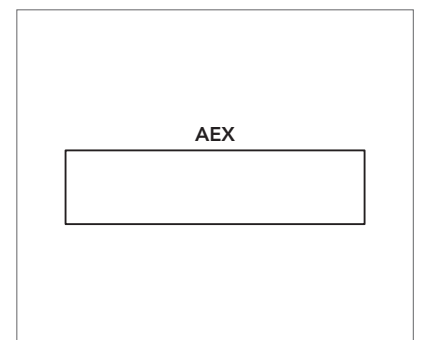

Straight AEX edge ensuring fast mounting and full demountability.

System components and consumption guide

Tile	Chicago Metallic 50 mm Bandraster 3050		Hold-down frame				Wall angles	Accessories				
	1	2	3	4	5	6	7	8	9	10	11	
-	Main runner 50 mm, 3600 mm	Cross tee 50 mm, 1150 mm	Hold-down C-profile 1168,6 mm	Hold-down C-profile 555 mm	Straight connector	Angled connector	Perimeter wall angle trim	Bandraster coupling	Bandraster cross connector	Nonius-hanger	Bandraster wall connector	
Modular dimensions (mm)	Consumption/m ²											
1200 x 1200	0,70 pcs/m ²	0,83 lm/m ²	0,83 lm/m ²	1,62 lm/m ²	0,77 lm/m ²	2,77 pcs/m ²	2,77 pcs/m ²	1)	0,23 pcs/m ²	1,39 pcs/m ²	0,70 pcs/m ²	1)

1) Consumption depends on room size.

Tile - AEX Edge 1166 x 1166 mm



Chicago Metallic 50 mm Bandraster 3050

1. Main runner 50 mm, 3600 mm



2. Cross tee 50 mm, 1150 mm



Hold-down frame

3/4. Hold-down C-profile



Hold-down frame

5. Straight C-profile connector



6. Angled C-profile connector



Wall angle

7. Perimeter trim



Accessories

8. Bandraster coupling



9. Bandraster cross connector



10. Nonius hanger



11. Bandraster wall connector



Performance



Impact resistance

Class 1A, tested in accordance with EN13964-Annex D. Impact resistance classifications confirm the system's capability to withstand incidental or occasional impact.



System load bearing capacity

		Max. Load bearing capacity (kg/m ²)	
Hanger distance (mm)	Module size (mm)	Max. 2,5 mm deflection	Max. 4,0 mm deflection
1200	1200 x 1200	20,2	33

The system's load capacity is determined from a max. deflection of the individual components corresponding to 1/500 of the span or the cumulative deflection of all structural components which does not exceed 2,5 or 4,0 mm. The load bearing capacity is given as regularly distributed load in kg/m² – it is the weight of the tile plus any additional items



Corrosion resistance

Class B (EN13964).



Demountability

Tiles mounted in Rockfon System Olympia^{Plus} A Impact 1A are fully demountable.



Fire resistance

Some Rockfon ceiling systems have been tested and classified in accordance with European norm EN 13501-2 and/or national norms. Please contact Rockfon.

Compatible Tiles

Rockfon System Olympia^{Plus} A Impact 1A can be installed with the following Rockfon tiles:

		Dimensions (mm)	
Tiles	Thickness (mm)	1166 x 1166	1200 x 1200
Rockfon Boxer	40	•	•
Rockfon Samson	40	•	•

Grid Installation

Grid layout and hanger location

This ceiling system has a module dimension of 1200 x 1200 mm. Unless otherwise specified, the suspension system must be symmetrical within the room.

If size (a) is used at the start of the longitudinal direction, then this size must also be used at the other end of the room. It is not recommended to fit tiles which have been cut to a length which is shorter than half the width or length of the tile.

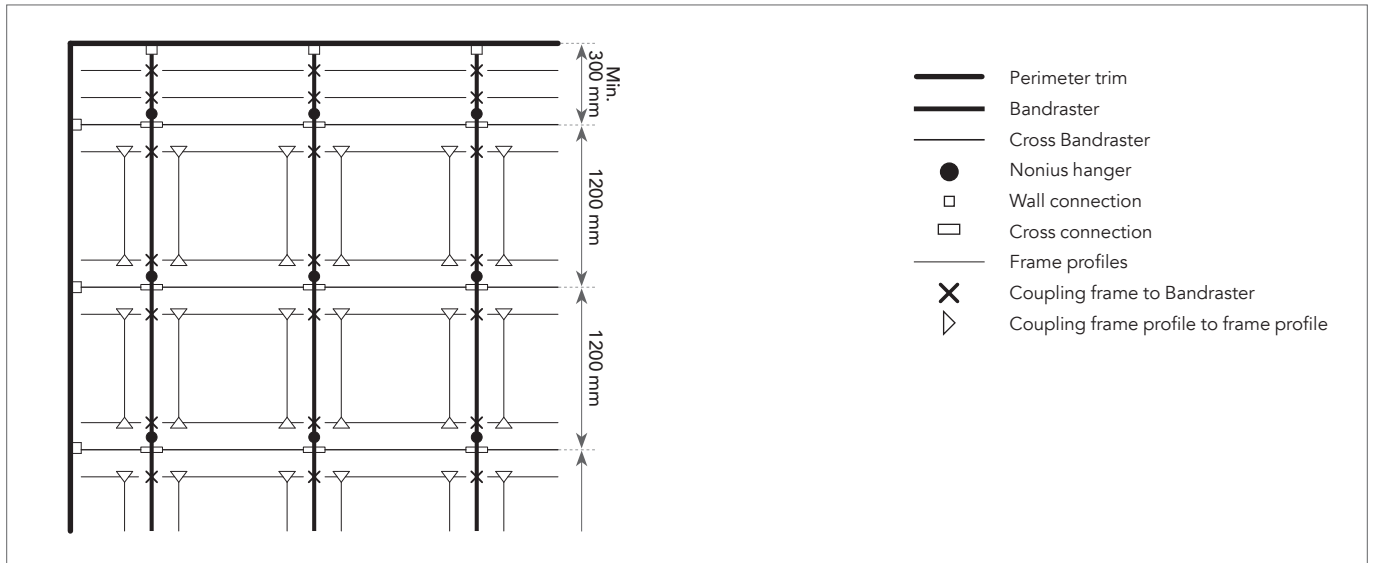

Installation requirements

During and after grid installation, it is important to check that Bandraster profiles are perfectly aligned horizontally. A maximum level difference of +/- 1,0 mm is recommended between profiles and should not be added. This tolerance is valid for all directions.

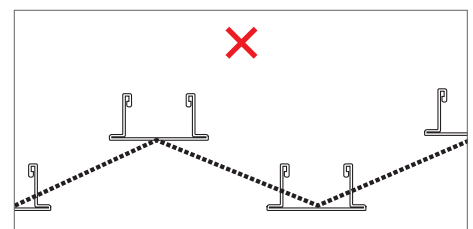
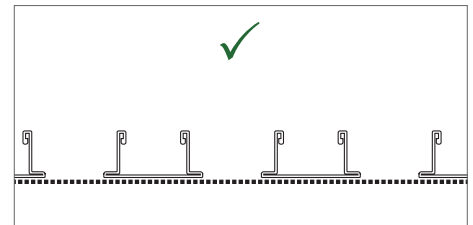

It is important to check the squareness of the angles between the bandraster main runners and the bandraster cross tees. This can be easily done by comparing the measurements of the two diagonals. See examples and recommended tolerances on the drawings to the right.

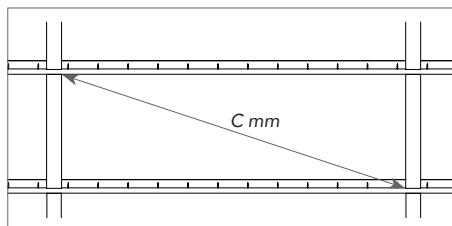

Dimensions	Diagonal (C)	Tolerance
1200 x 1200	1626,34	+/- 1,0

Hold-down frame

The Rockfon tiles (40 mm thick) are held in place by a H-shaped hold-down frame. This is made from 2 x 2 lengths of C-profile. The two long C-profiles bridge the distance from main runner to main runner, whilst the two short C-profiles bridge the distance between the two long C-profiles. The short and the long C-profiles are connected together by the straight C-profile connector. Angled C-profile connectors

are fitted to the end of the long C-profiles and clicked into the slots in the main runners. The hold-down H frame should be installed symmetrically in the 1200 x 1200 mm module.

NB: Pay special attention to the location of the alignment of the slots, so that the angled C-profile connectors can be clicked in place. Slots must be aligned.

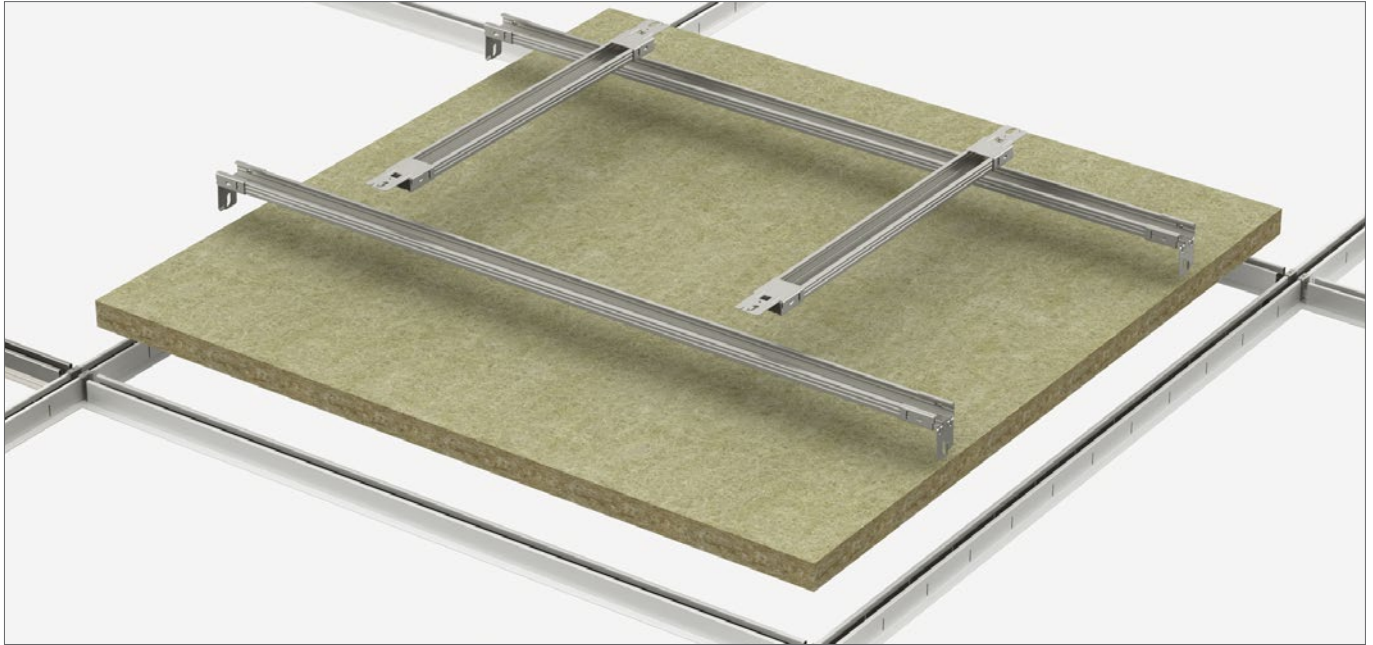

Perimeter trims



Grid component attached to a wall.

Fit the bandrastrer wall connector to the main runner or cross tee using self tapping screws. Fasten the connector to the wall using appropriate fixings.



Hold-down C-profile attached to a wall.

Fit the angled C-profile connector to the C-profile using self tapping screws. Fasten the connector to the wall using appropriate fixings.

Assembly

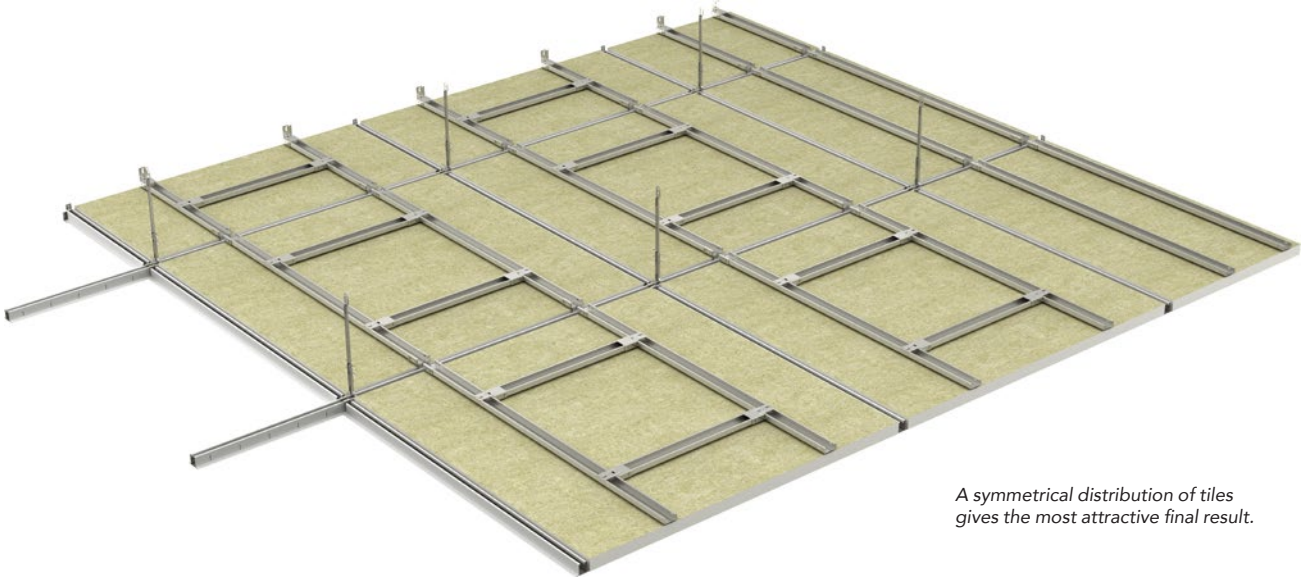

A symmetrical distribution of tiles gives the most attractive final result.

Connection between the ceiling and a wall

Perimeter trims must be levelled against a wall (and be aligned). The distance between fixing points on a perimeter trim must not exceed 300 mm. For fire-resistant constructions, the perimeter trims must be attached directly against the wall or be fitted with fire-resistant battens.

Connection between the ceiling and curved vertical surfaces

When the ceiling connects with a curved vertical surface, pre-shaped trims must be used.

Demounting

Demounting Rockfon tiles

The tiles can be easily demounted. As a result of the space between the back of the ceiling tile and the bottom of the hold-down frame,

the tiles can be raised approximately 10 mm. Every tile can be removed by disconnecting two of the four angled C-profile connectors out of the cross tees using the removal tool supplied or pliers or a hook.



The tiles can be easily demounted.

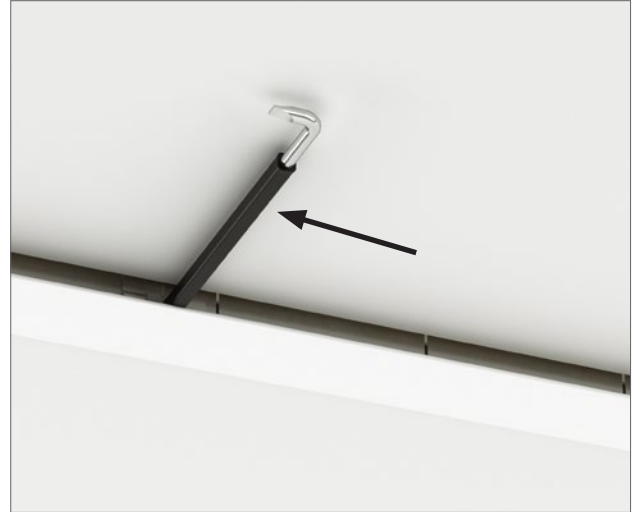

Further information

Resistance to corrosion

The system meets corrosion class B in accordance with table 7 of the European product standard EN 13964. All the parts are made from Z100 steel (minimum zinc layer of 100 g/m²). As a result, the system is suitable for use in rooms with a maximum relative humidity of 90% at a maximum temperature of 30° C.

Minimum installation depth (mm)

Tiles mounted in Rockfon System Olympia^{Plus} A Impact 1A give full demountability. The installation depth is defined as the distance from the underside of the tile to the underside of the substrate, where the hangers are fixed. D is the minimum installation depth for easy tile installation and demountability.

Mounting method	D = Minimum installation depth
Suspended with nonius hangers	200 mm

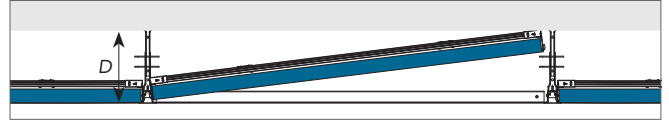

Perimeter Finish Options

Below are examples of perimeter finishing. Further details can be found on cee.rockfon.international

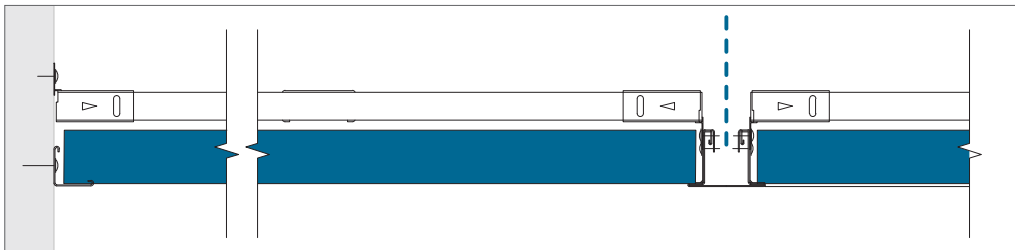

Perimeter finish with wall angle trim.

Service integration

Rockfon ceiling tiles are easy to cut and therefore it is very easy to integrate service installations in our ceiling tiles. The cut-outs can be made with a simple utility knife.

Specific lights have been tested in accordance with EN13964 Impact resistance class 1A. Impact resistance of other types of lights is not guaranteed. Contact your local Rockfon technical service for more information on suitable lighting fixtures and accessories and availability of CAD drawings of the different services integrated in Rockfon System Olympia^{Plus}. Special solutions with integrated services are, if available, shown on page 11 of this document; 'Tools'.

Planning

A proper planning of the jobsite will result in less re-work and less ceiling tile damages. Rockfon recommends discussing the jobsite planning thoroughly and well in advance with other installers that have to work in or near the suspended ceiling. By doing so damaged ceiling tiles and dirty spots on the finished ceiling surface can be avoided, which reduces costs on the jobsite.

Drawing A

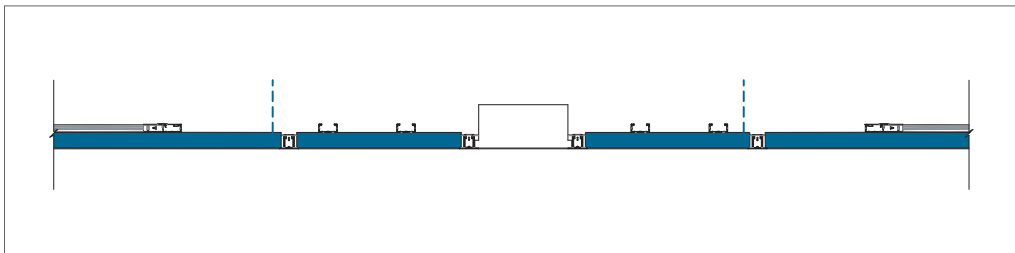

General installation recommendations

Junction between ceiling and wall or other vertical surface

The perimeter trim should be fastened to vertical surfaces at the required level using appropriate fixings every 300 mm. Ensure that butt joints between adjoining lengths of trim are neat and that the trim is free from kinks and remains true and level. For the best aesthetics, use as long a length of trim as possible. The minimum recommended cut length is 300 mm.

Timber trims, timber shadow battens and metal

Shadow mouldings should not be used with fire resisting/protecting ceilings.

Junction between ceiling and curved vertical surface

The use of a preformed curved perimeter trim is the most appropriate method. Rockfon can provide details of curved perimeter trims on request.

Corners

Perimeter trims should be neatly mitred at all corner joints. Overlap mitres are acceptable on metal trims on internal corner joints unless specified otherwise.

Suspension grid

Unless specified otherwise, the ceiling should be set out symmetrically and where possible, perimeter tiles should be greater than 200 mm in width. The hangers should be fastened with appropriate top fixings and to the bandraster at 1200 mm centres (or less with greater load).

For proper grid installation, make sure the bandraster profiles are perfectly aligned horizontally and diagonals or modules are equal (see requirements and tolerances on page 5). Bandraster joints should be staggered and within 450 mm of the end of the bandraster where it terminates at a perimeter.

Additional hangers may be necessary to support the weight of ceiling services.

Tiles

It is recommended to use clean nitrile or PU coated gloves when mounting Rockfon tiles in order to avoid finger prints and pollution of the surface.

For an optimized work environment, we recommend installers always observe common work practices and follow the installation advise as shown on our packaging.

Cutting is made easily with a sharp knife. All off-cuts and holes must be treated according to local Building Regulations.

Note! Certain smooth matt surfaces are directional. To ensure consistency of the finished ceiling, it is important that all tiles are mounted in one direction indicated by the arrow printed on the back of each tile.

Tools

Rockfon has developed specific tools that are available on cee.rockfon.international



Visit our online CAD Library or BIM portal to assist you in your project design.

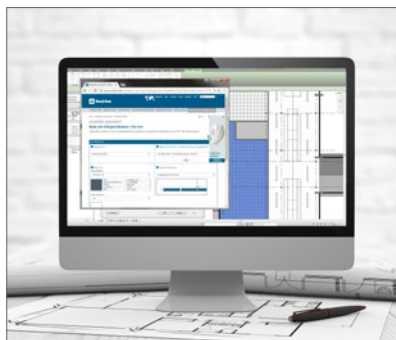

Generate specification texts for our products on our website.



Explore our vast library of reference projects on our website.

Sounds Beautiful

