

INSTALLATION GUIDE

# Rockfon® System Eclipse Island™

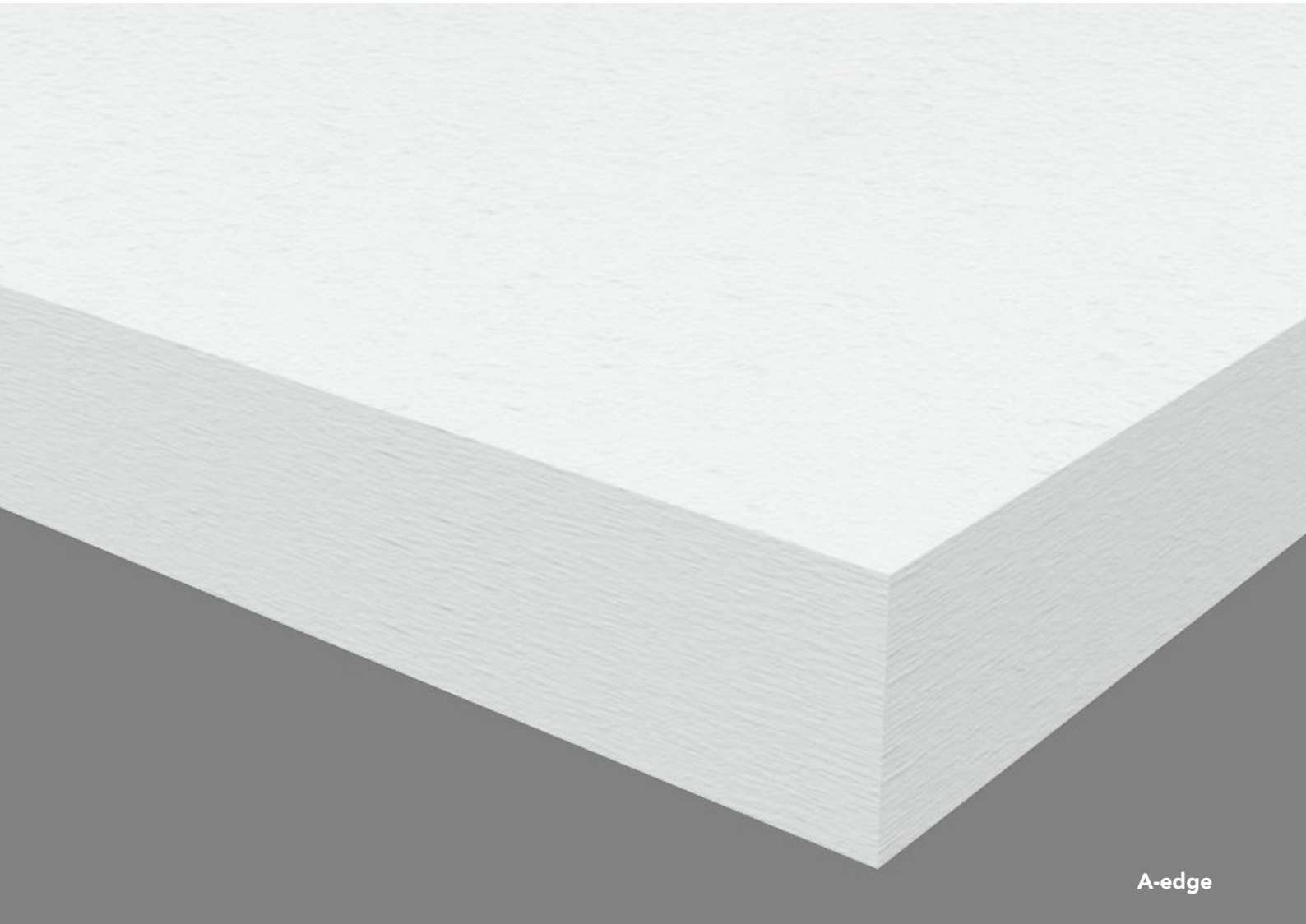

## Frameless island system

- Ideal solution for rooms where a suspended ceiling is technically or aesthetically not suitable
- Perfect solution for room acoustic improvement
- Available in different shapes and colours
- Easy and quick installation

**Sounds Beautiful**

## Description

**Rockfon System Eclipse Island** is a frameless acoustic solutions available in a variety of geometric shapes and comes in three different versions that all feature a minimalistic straight painted A-edge. Our Rockfon Eclipse is covered with a smooth, deep matt, super white painted fleece that has anti-static properties, extending product lifetime. If you are looking to add colour to your project, you can also choose Rockfon Eclipse Colour, which comes in a variety of pre-defined colours\*, or Rockfon Eclipse Customised, which is our custom colour offering. The reverse side of the island is covered with a white acoustic fleece.

Rockfon Eclipse can be suspended under an existing soffit, T24 grid or gypsum ceiling. Using specifically designed accessories, it can be fixed directly to the soffit itself (page 12-14). The Rockfon Eclipse Rectangle, 2360 x 1160 x 40, has two special white aluminium profiles that are integrated to the backside of the island providing extra stability during the installation.

This acoustic system is ideal in rooms and buildings where the use of a traditional suspended ceiling is technically not appropriate (e.g. where the principle of thermal mass is incorporated in the building design) or is aesthetically unappealing. It is a good and flexible solution to make room acoustic improvements in existing buildings.

### Restrictions

Due to the risk of corrosion, the suspension accessories of Rockfon System Eclipse Island should not be used in swimming pools or outdoor environments. Furthermore, Rockfon System Eclipse Island should not be used in areas subjected to wind load and drafts.

Rockfon does not advise to install Eclipse islands with edges against each other. A min. gap of 4 mm between 2 Eclipse islands is advised.

\* Please reference our Rockfon Eclipse Colour datasheet to see the available colours.

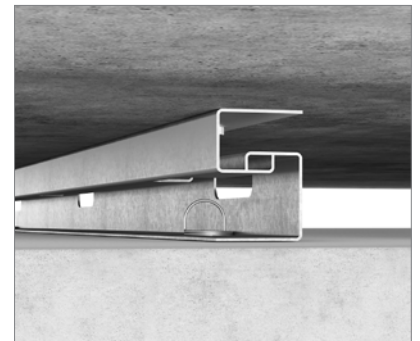

Direct installation of Rockfon Eclipse Islands can be made with the Rockfon Eclipse Direct Solution Suspension Kit.



Rockfon spiral anchor is delivered together with a Rockfon Eclipse suspension kits.

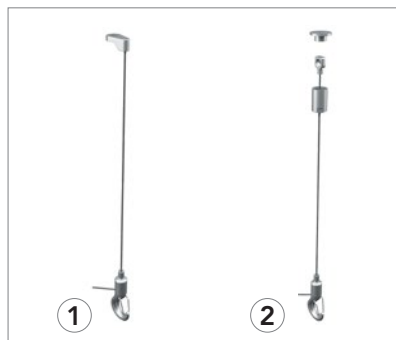



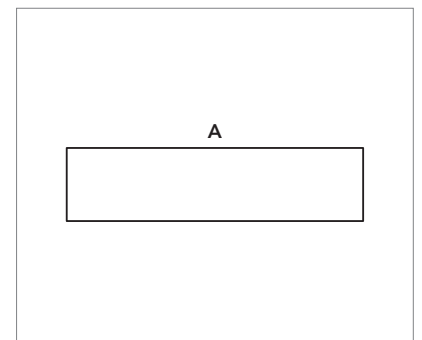

Rockfon has two suspension kits variants with 1500 mm adjustable metal wire and safe attachment hook.  
1. Classic solution  
2. Design solution

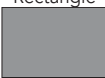

Minimalistic painted straight A edge.

## System components

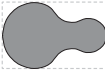
Rockfon Eclipse			
Shapes	Dimensions (mm)	Weight (kg/unit)	MS / MS easy access* (mm)
 Square	1160 x 1160 x 40***	9,0	55 190
 Rectangle	1760 x 1160 x 40 2360 x 1160 x 40**	13,0 17,0	190 190
 Circle	800 x 800 x 40 1160 x 1160 x 40***	3,0 7,0	190 190
 Triangle	1160 x 1005 x 40	4,0	190
 Hexagon	1160 x 1006 x 40	6,0	190
 Oval	1760 x 1160 x 40	10,0	190
 Free-form	1760 x 1160 x 40	9,0	190

MS = Minimum suspension.

\* Thickness of the tile is included.

MS easy access = Minimum suspension - tiles demountable.

All rectangle and square Rockfon Eclipse in custom colours are only available in a Be-edge.

\*\* Size 2360 x 1160 x 40 is only available in custom colours on one side.

Contact us for special shapes, colours, sizes, lead times and minimum quantities.

\*\*\* Available as Rockfon Eclipse Colour.

Rockfon Eclipse should be secured with a suspension kit comprising of a 1500 mm long adjustable metal wire and a safety attachment hook. Once assembled, the wire is attached to the island by a spiral anchor that is delivered together with the Rockfon Eclipse suspension kit. We provide two suspension kits; the Classic solution and the Design solution, which is optimal for projects where aesthetics are important.

Rockfon Eclipse suspension kits – Classic solution	
Units/box (incl. spiral anchors)	Weight (kg/box)
4 sets of 4	0,91
4 sets of 6	1,40

The Rockfon Eclipse Classic suspension kit can be secured using a standard setscrew that corresponds to the relevant soffit material (e.g. concrete, wood...).

Rockfon Eclipse suspension kits – Design solution	
Units/box (incl. spiral anchors)	Weight (kg/box)
2 sets of 4	0,44
2 sets of 6	0,80
2 sets of 4 (incl. 2 x 6 spiral anchors)*	0,50

\* Suitable packaging concept for Rockfon Eclipse Rectangle 2360 x 1160 mm, when mounted without additional load.

The Rockfon Eclipse Design suspension kit features a refined cylindrical capping that hides the screw thread and provides a visually appealing finish. It can be fastened using a standard set screw that corresponds to the relevant soffit material. Alternatively a M6 thread wire can be used.

**We only guarantee the integrity of the Rockfon System Eclipse Island if it is installed with Rockfon spiral anchors.**

### Island – A Edge



### Accessories

1. Direct fixing bracket



2. Spiral anchor



3. Suspension kits – Classic solution



4. Suspension kits – Design solution



5. Shallow profiles



## Performance



### System load bearing capacity

The maximum load per spiral anchor is 5 kg. Refer to the Service Integration section for recommendations regarding cutouts, for the integration of lights and similar services.



### Corrosion resistance

Due to the risk of corrosion, the suspension accessories of Rockfon System Eclipse Island should not be used in swimming pools or outdoor environments.

## Compatible Tiles Overview

Rockfon Eclipse and Rockfon Eclipse Colour can be used in a Rockfon System Eclipse Island.

## Installation

When installing any of the Rockfon System Eclipse shapes, please use the marking tool below:

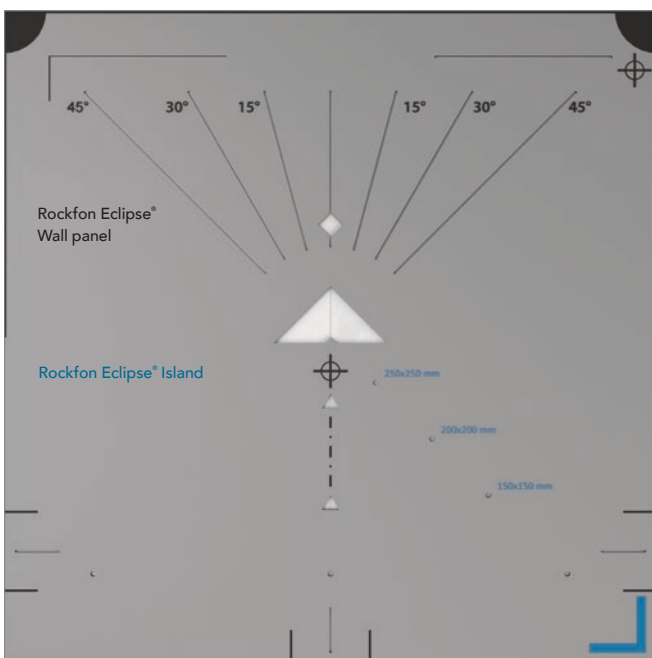

Marking tool.

Black prints are for the Rockfon Eclipse Wall panel.  
Blue prints are for the Rockfon Eclipse Island.

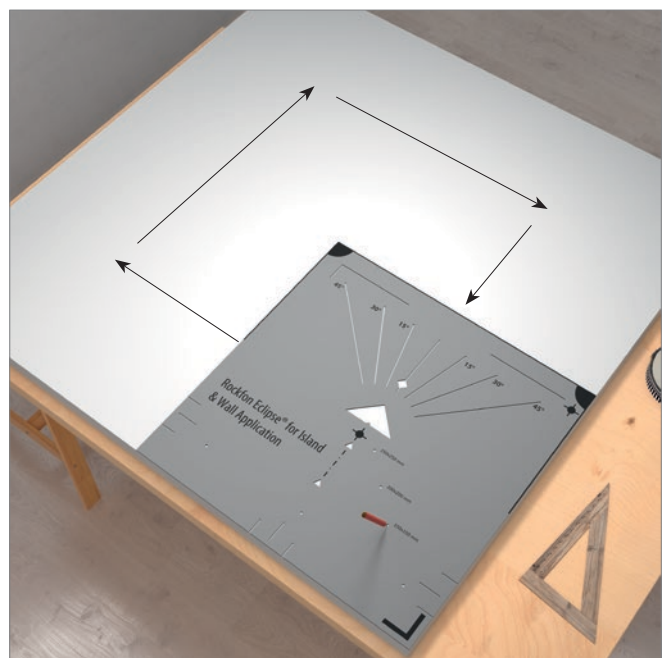

## Installation

Boxes should be handled with care and by two people. They should be stored in a flat, horizontal position. Each box contains a pair of gloves that should be worn when handling Rockfon Eclipse.

For an optimised work environment, we recommend installers always observe common work practices and follow the installation advise, as shown on our packaging.

To minimize the risk of damage and for faster and easier installation, a Rockfon Eclipse Island should be handled by two people.

### Fixing spiral anchors to the Island

**Rockfon Eclipse Square 1160 x 1160 mm and  
Rockfon Eclipse Rectangle 1760 x 1160 mm**

Spiral anchors need to be screwed vertically into the back of the island at a minimum distance of 150 mm from the edge.

The minimum distance between spiral anchors should be 600 mm. The maximum load per spiral anchor is 5 kg. Four spiral anchors are required for a 1160 x 1160 mm island. In the case of 1760 x 1160 mm islands, six suspension points are required and should be distributed evenly.

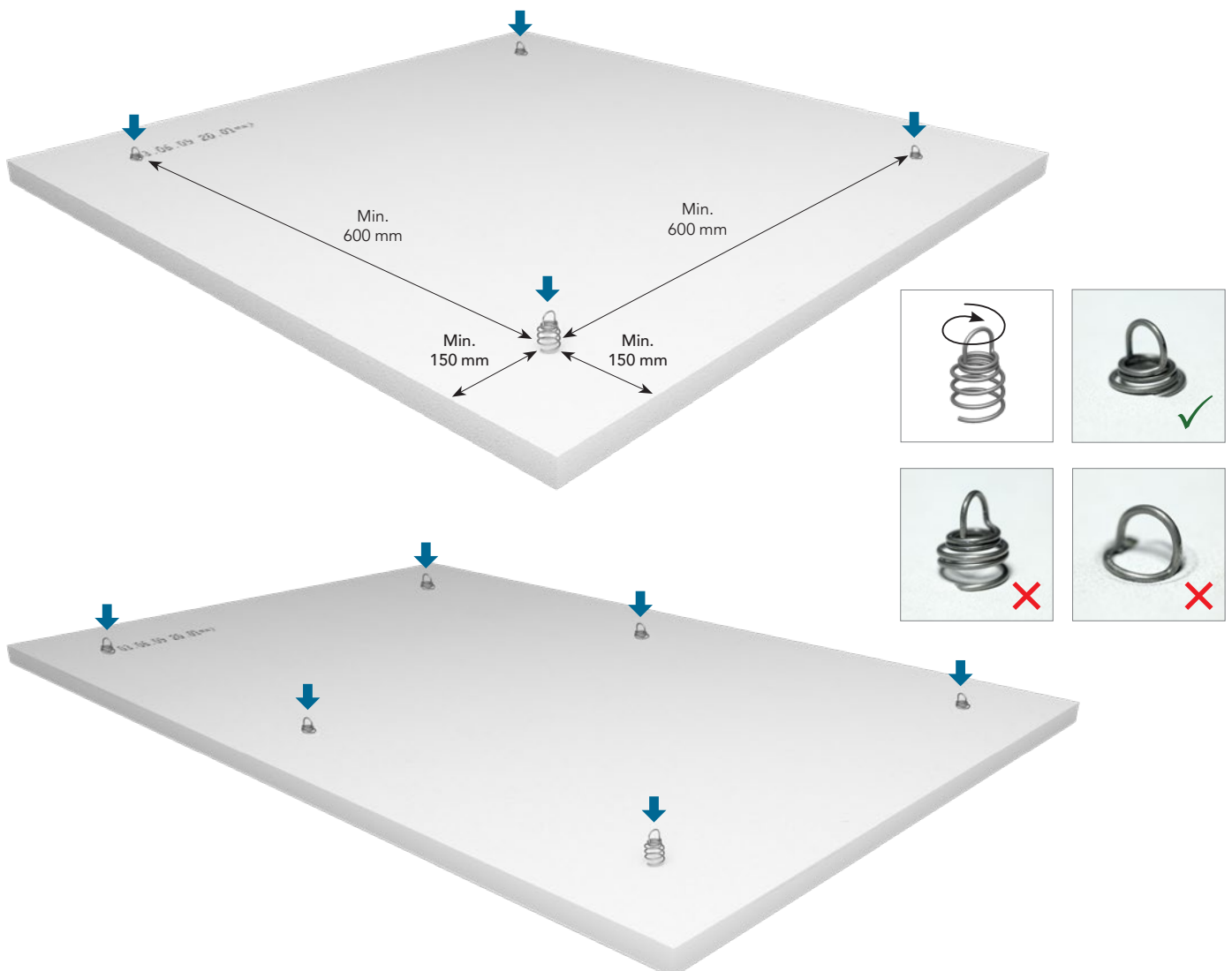

### Rockfon Eclipse Rectangle 2360 x 1160 mm

Rockfon Eclipse Rectangular 2360 x 1160 mm comes with two aluminum profiles on the back of the island. Both profiles have five holes where a spiral anchor can be placed. The position of the spiral anchors is dependent on the installation method (described below), but for safety reasons at least six spiral anchors are needed in all situations.

**Note:** It is highly recommended to install Rockfon Eclipse Rectangle 2360 x 1160 mm level so that the weight is distributed evenly over all suspension points. The use of an installation table can be very helpful!

On all installations of Rockfon Eclipse Island (2360 x 1160 mm Rectangle) there must be at least 6 spiral anchors inserted into the Eclipse Island through the pre-made holes of the reinforcing strips in the back of the islands (i.e. 3 per side) as shown below.

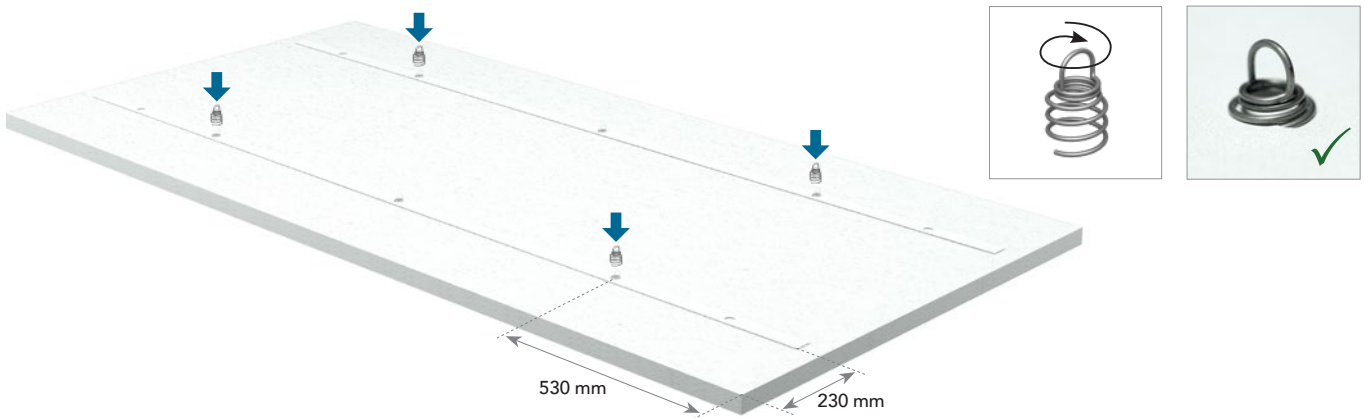

Each reinforcing strip has five pre-made holes, three of which must be used to insert the spiral anchors. The holes utilised and the number of suspension sets required to suspend the Island will depend on whether there are any services being installed into the Island:

For installations where there will be **no additional load** placed on / integrated within an island; the central three holes should be utilised.

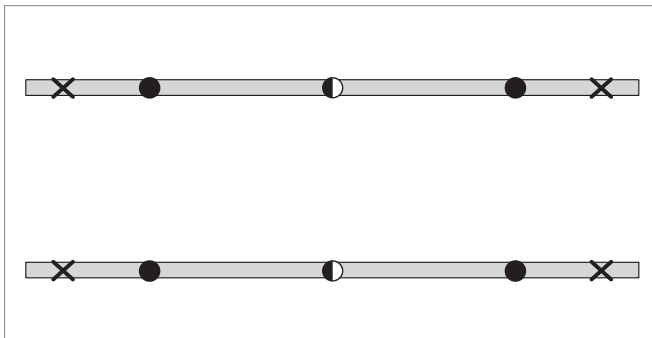

6 spiral anchors: 4 must be used for suspension.

For installations where **additional loads up to 5 kg** will be integrated within an island; the central hole and outermost holes should be utilised

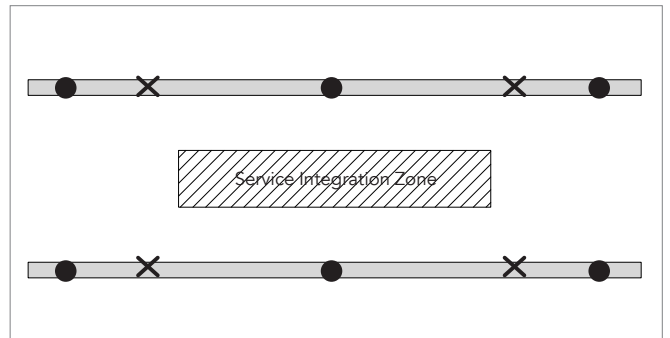

6 spiral anchors: All 6 must be used for suspension.

- Spiral anchor and suspension hanger
- Spiral anchor only
- ✕ Hole not utilised

**Rockfon Eclipse Shapes**

The spiral anchors should be distributed symmetrically as indicated below and at a minimum distance of 100-150 mm from the edge.

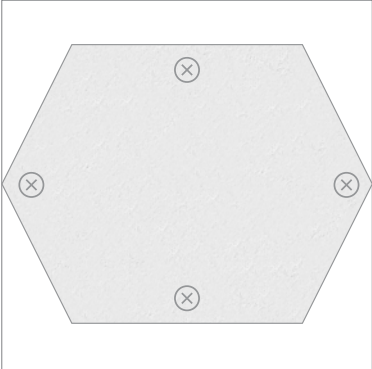
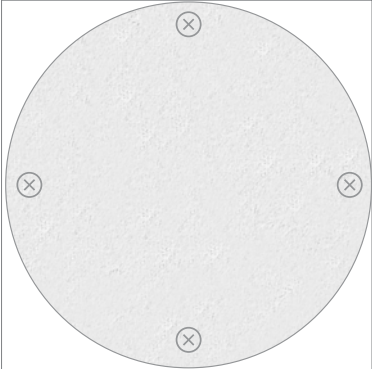

*Eclipse circle of 800 mm can be suspended with 3 hangers.*

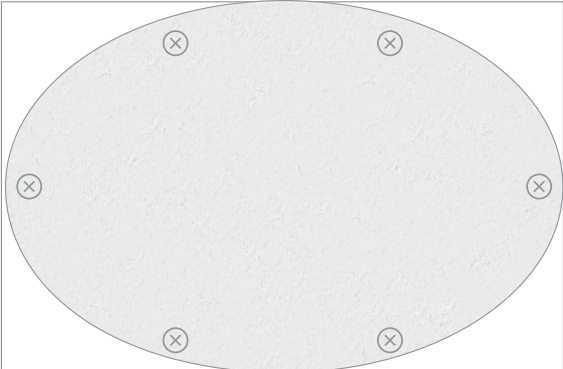
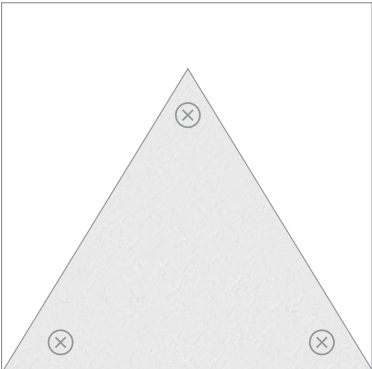

### Connecting Rockfon System Eclipse Island to the structure

Please ensure that the supporting structure is solid and that it has a load bearing capacity of at least 25 kg. Attach the wire to the soffit fixing points. Slide the wire into the hook. The system locks automatically providing maximum safety. Attach the hooks to all of the spiral anchors. Ensure that all hooks are correctly attached before raising the island to the required height. Use two people in order to prevent that the island is only attached by one or two hooks.

The maximum load per wire is 5 kg, and the minimum installation depth, i.e. the distance from the visible surface of the island to the structure, e.g. the ceiling, is 190 mm.

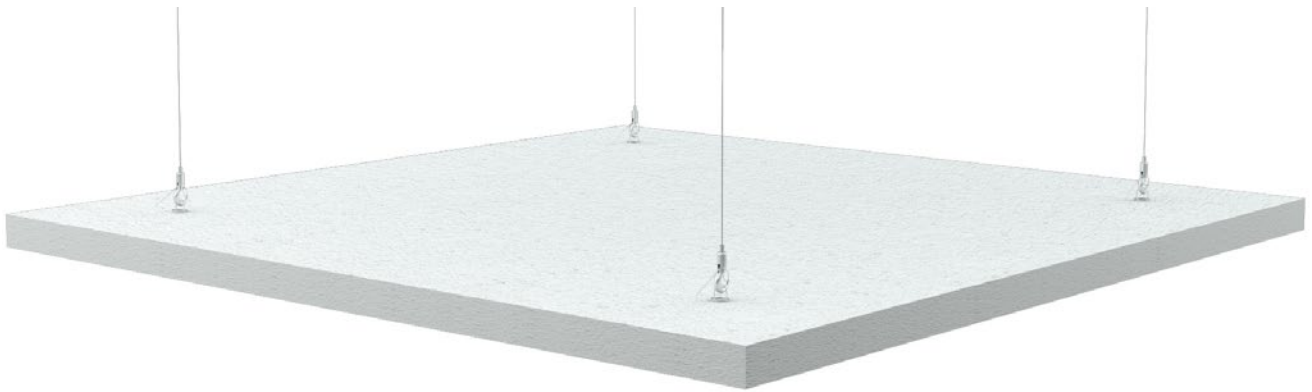



### Leveling

Adjust the level by using a spirit level. Always make sure that the island is attached at all points so that the weight of the island is evenly distributed. Rockfon Eclipse can also be installed at a maximum angle of 45°.

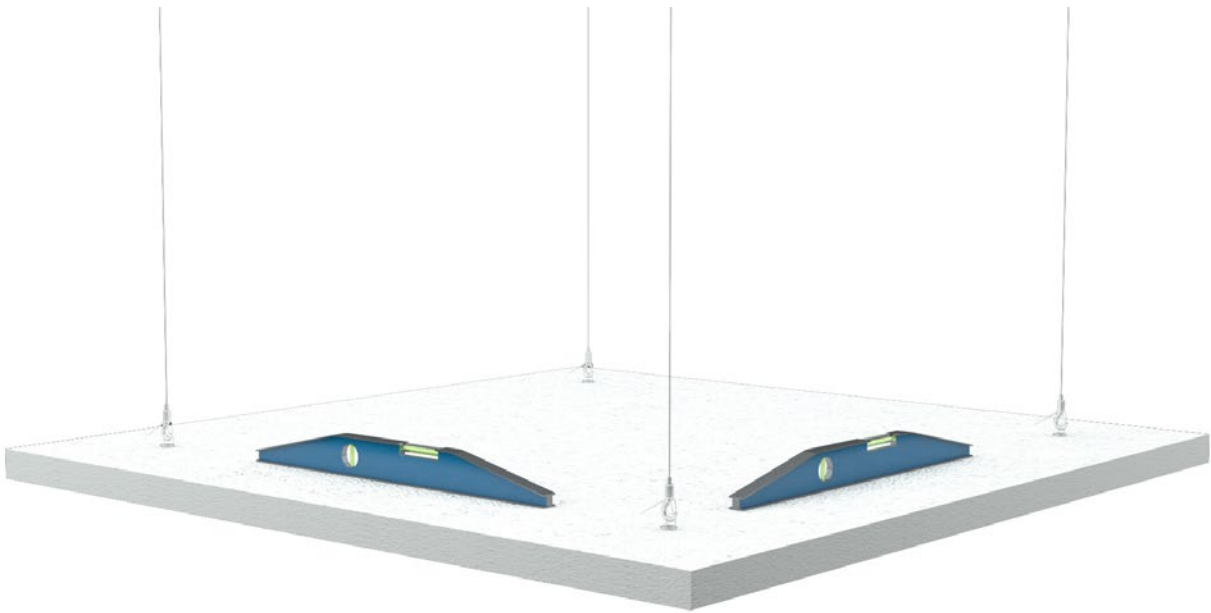

### Installing Rockfon System Eclipse Island below an existing suspended ceiling

It is possible to fix the Rockfon System Eclipse Island to existing T24 grids (see illustration N°1) by using standard accessories (see illustration N°2) sold via ceiling distributors. Check with your grid supplier to ensure that the grid can support the load of the Rockfon System Eclipse Island. Also confirm with the accessory supplier to ensure that the fixing clip can support a load of 5 kg.

It is also possible to install the Rockfon System Eclipse Island below a suspended ceiling by having the wires pass through the ceiling tiles and fixing the suspension kit to the structure (eg. concrete soffit) as in illustration N°3.

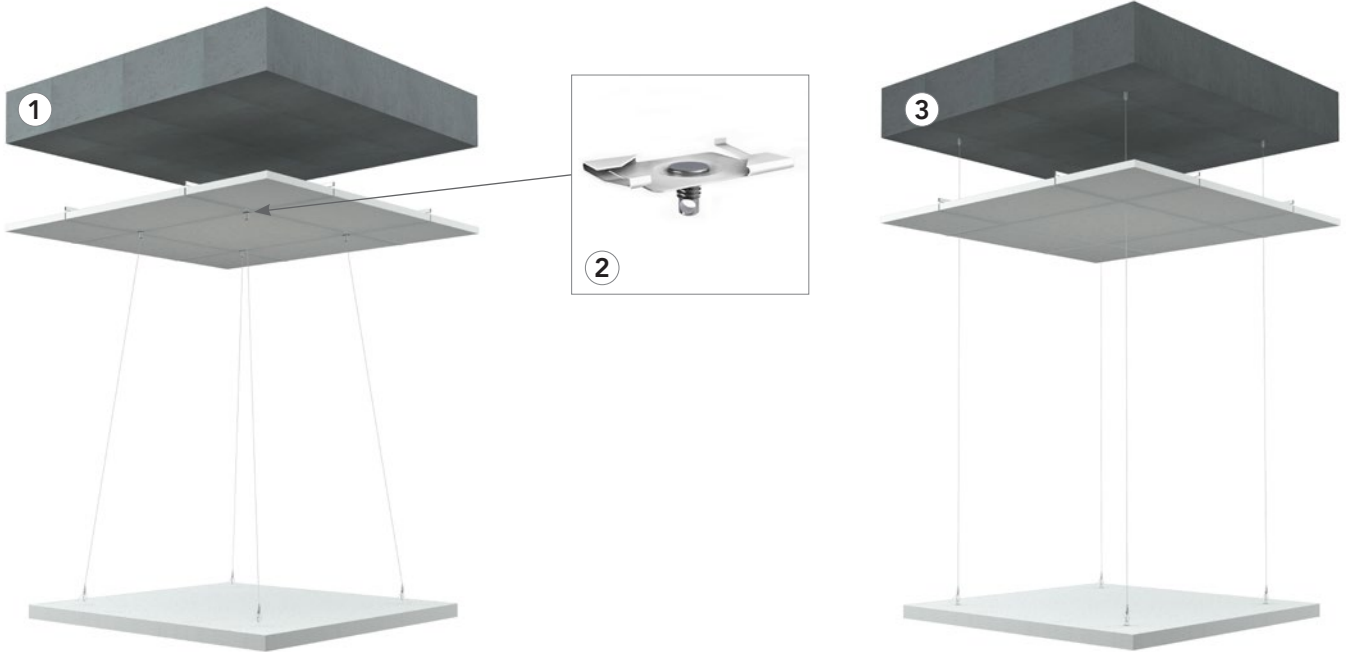

### Installing Rockfon System Eclipse Island below an existing gypsum ceiling

**Using a plate:** Check with the plate supplier to ensure it can support a load of 5 kg per suspension point.

Drill a hole into the gypsum board. Slide the cable stopper plate through the hole and let it rest flat above the gypsum board.



### Using a gypsum plug

Check with the gypsum plug supplier to ensure it can support a load of 5 kg. Screw the gypsum plug with a M6 thread connection into the gypsum board.

Fix the Rockfon Eclipse suspension kit to the M6 connection.

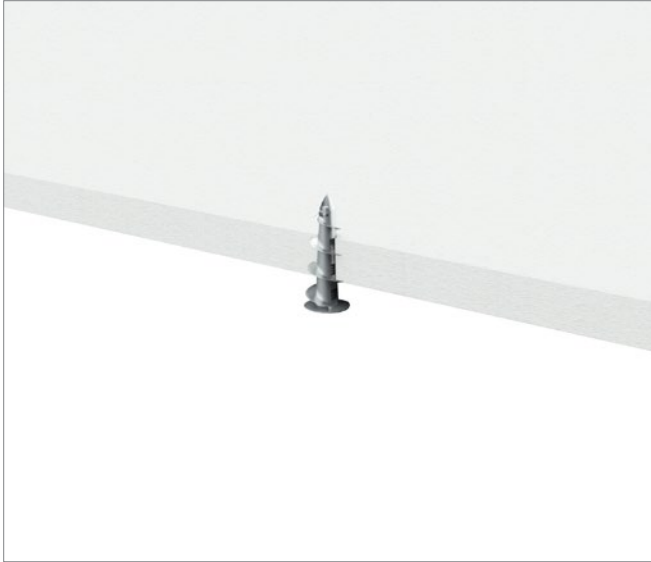

### Using a spring toggle

- 1) Check with the spring toggle supplier to ensure it can support a load of 5 kg. Drill into the gypsum board. Screw the M6 threaded rod into the spring toggle. Insert it into the gypsum board.
- 2) Once the spring toggle passes through the other side of the gypsum board, it opens out and holds the threaded rod in place.
- 3) Screw the Rockfon Eclipse suspension kits into the M6 threaded rod.



### Installing Rockfon System Eclipse Island direct to the soffit

Direct installation of Rockfon Eclipse to the soffit is possible with the Rockfon Eclipse Direct Solution Suspension Kit. The space between the backside of the island and the soffit is 45 mm.

#### Installation method

Ensure that the soffit is smooth and even. Carry out any smoothing/levelling work before installation of the system. If necessary, install a framework to compensate for uneven soffits.

Not levelling the soffit can cause some visible height differences between soffit and island. The use of some additional basic galvanised metal angle brackets to act as 'stops' at the end of the direct fix profiles to ensure and maintain alignment and safety is recommended.

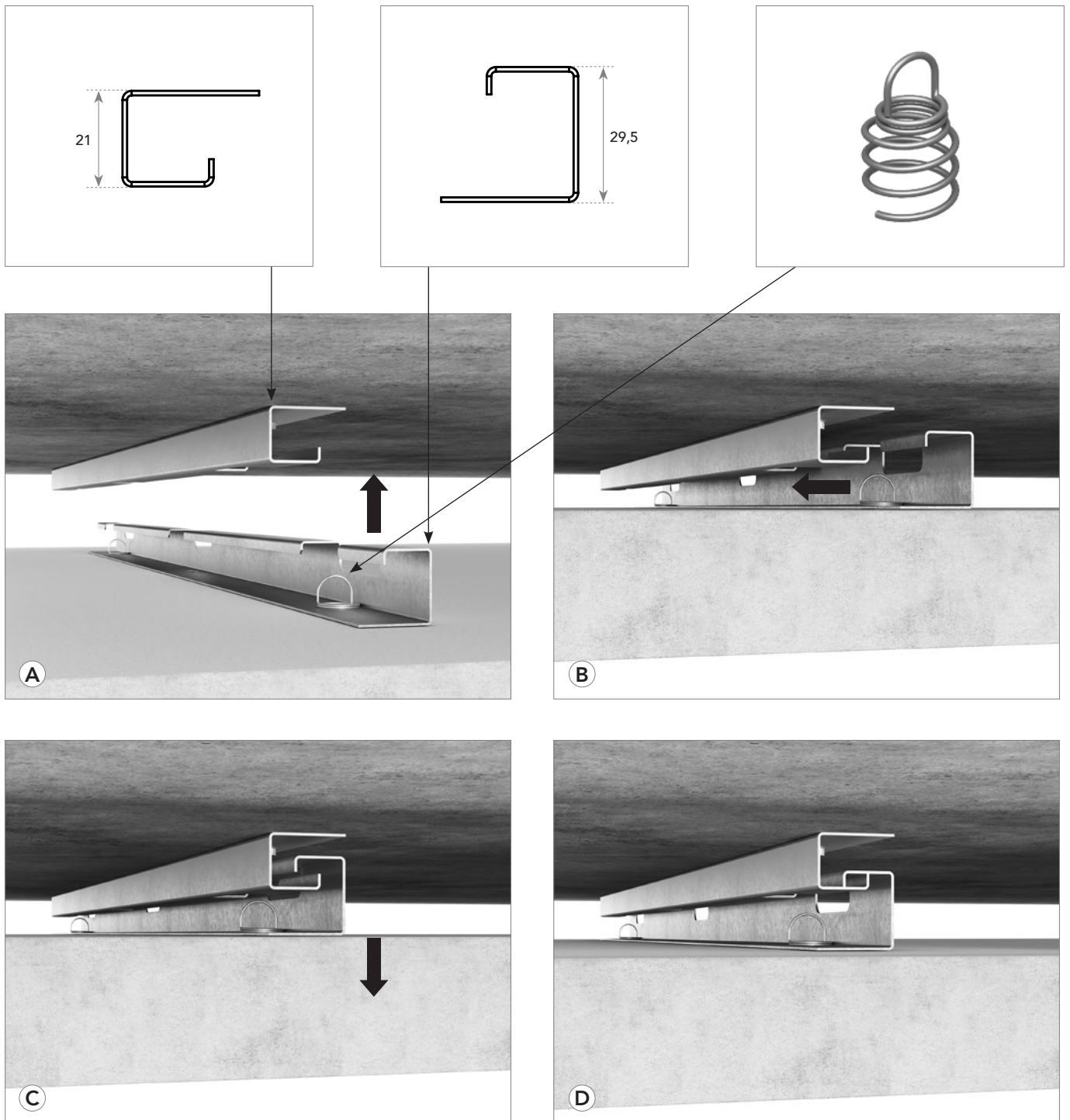



## Rockfon Eclipse Direct Solution Suspension Kit



We provide three suspension kits: one for 1160 x 1160 mm Rockfon Eclipse Islands, one for the 1760 x 1160 mm islands and one for the 2360 x 1160 islands, both consisting of 2 soffit profiles, 2 islands profiles, and 4 or 6 spiral anchors.

Packaging content of the Rockfon Eclipse Direct Solution Suspension Kits for Rockfon Eclipse	
Tile dimensions (mm)	Packaging content
1160 x 1160	4 kits, 8 soffit profiles, 8 island profiles, 16 spiral anchors
1760 x 1160	4 kits, 8 soffit profiles, 8 island profiles, 24 spiral anchors
2360 x 1160	2 kits, 4 soffit profiles, 4 island profiles, 12 spiral anchors

### Installation schemes

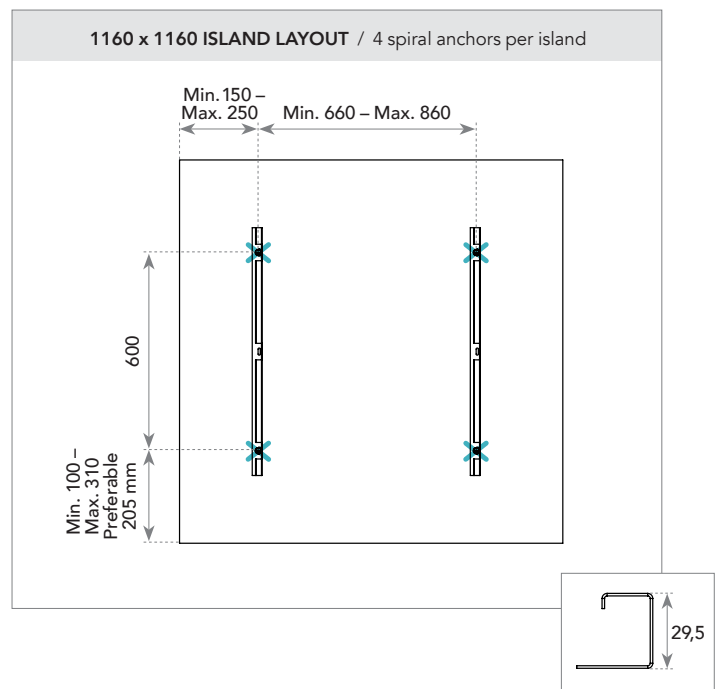
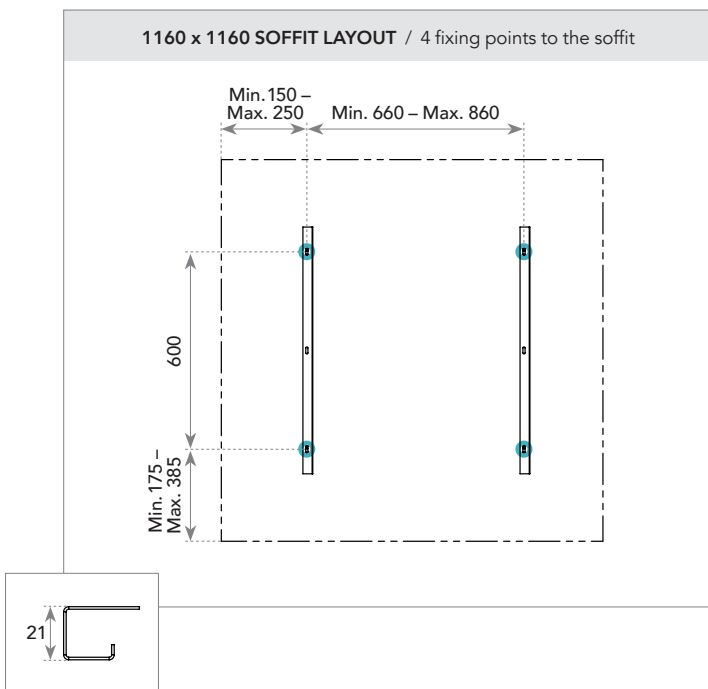
-  Spiral anchors
-  Suspension points



-  Spiral anchors
-  Suspension points

**1760 x 1160 SOFFIT LAYOUT / 6 fixing pints to the soffit**

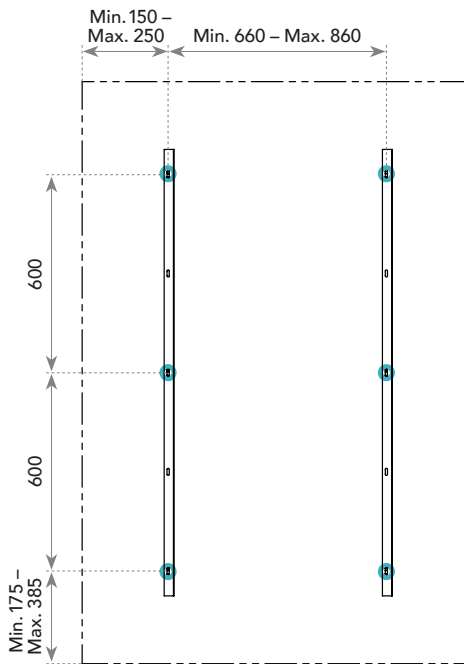

**1760 x 1160 ISLAND LAYOUT / 6 spiral anchors per island**

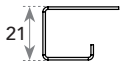
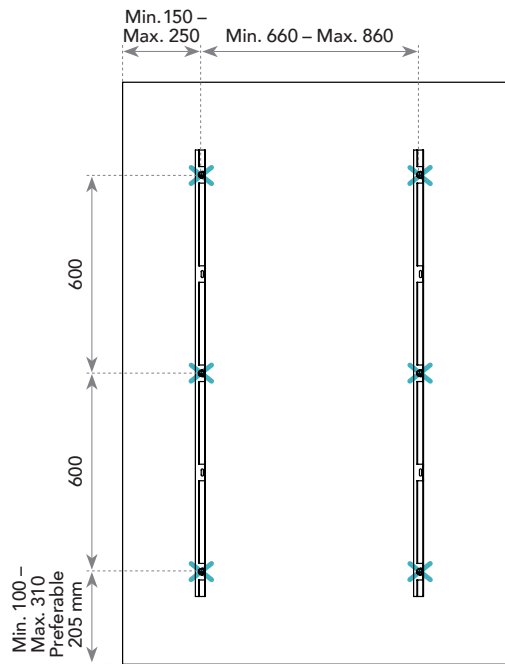

**2360 x 1160 SOFFIT LAYOUT / 6 fixing points to the soffit**

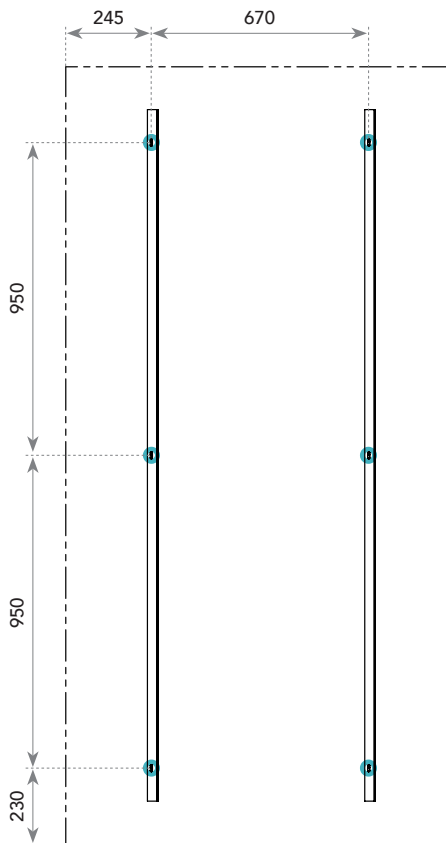

**2360 x 1160 ISLAND LAYOUT / 6 spiral anchors per island**

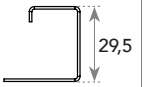
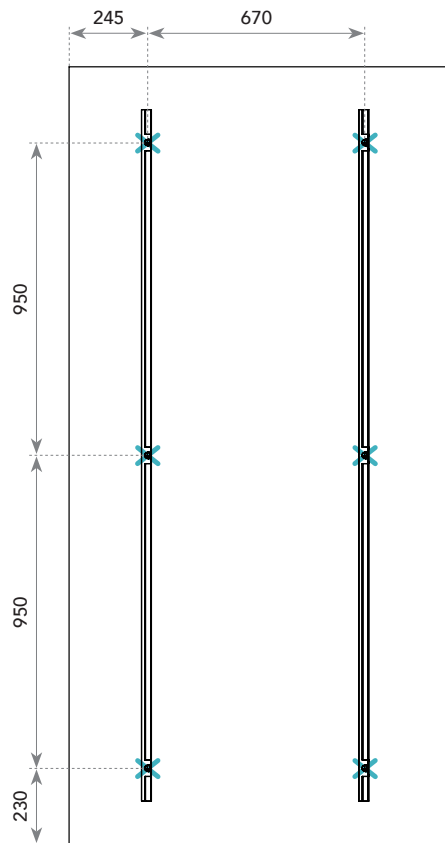

### Installing Rockfon System Eclipse Island direct to the soffit

Direct installation of Rockfon Eclipse to the soffit is possible with the "shallow" bracket. The space between the island and the soffit will be approximately 15 mm.

**Direct installation is not recommended for islands larger than 1200 x 1200 mm.**

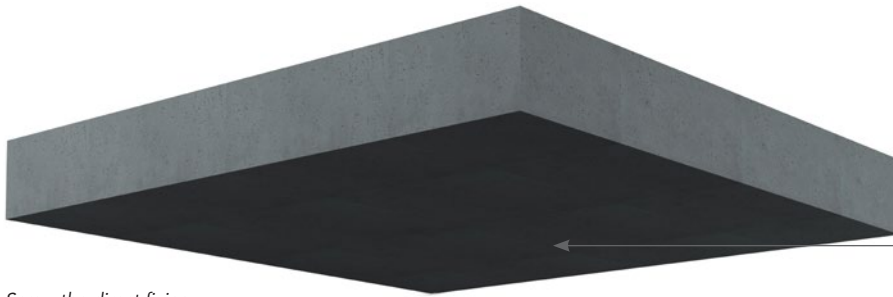

*Screw the direct fixing brackets to the ceiling.*



*Screw the spiral anchors into the Rockfon Eclipse Island.*

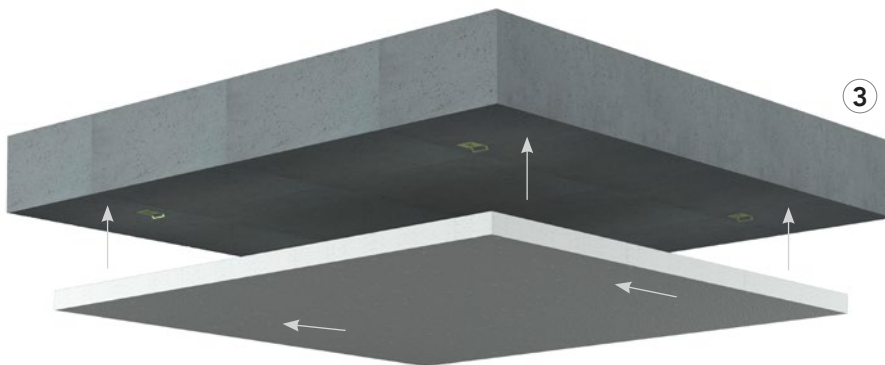

*Lift panel to the concrete soffit, then slide into the brackets.*

### Rockfon Eclipse Island cutout table

Rockfon Eclipse Island	Square 1160 x 160 mm	Rectangle 1760 x 1160 mm	Rectangle 2360 x 1160 mm	Circle Ø800 mm	Circle Ø1160 mm	Hexagon 1160 mm	Triangle 1160 mm	Oval 1760 mm
Min. cutout distance from edge (mm)	300	300	470 long side 350 short side	200	200	200	200	200
Max. cutout Size (mm)	560 x 560	1160 x 560	1420 x 460	Ø400	Ø760	350 edge	468 base	1360/760

### Common information on cutouts

- The dimensions in the drawings are maximum allowable cutouts.
- We advise to install lights or similar services symmetrically in the islands. Installation of lighting fixtures or other services should be completed according to the advise given above by Rockfon.
- We advise to use either a knife or a jigsaw to create the cutouts. However, the islands needs to be protected against scratches and dust. This can be done by putting a cardboard or paper between the jigsaw and the panel as protection material.
- Other cutout forms are possible, as long as they don't exceed the max. cutout area.
- Instead of one large cutout it is also permitted to have several smaller cutouts, insofar that they don't exceed the max. cutout area.
- For an optimised working environment, we recommend that installers always observe common workplace practices and follow the installation advise as shown on our packaging.

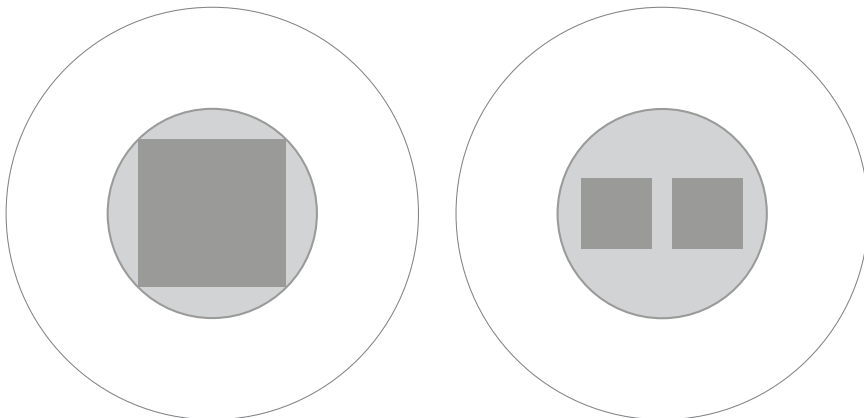



## Service integration

Rockfon Eclipse is easy to cut, making integration of service installations very easy. The cutouts can be made with a simple utility knife.

### Light installation

Adding lighting fixtures with a weight above 0.25 kg must be done independently. Rockfon System Eclipse Island should not support any additional material or fittings above 0.25 kg.

There is one exception though. A light fixture or beam light can be installed (max. 5 kg) in a Rockfon Eclipse Rectangle, 2360 x 1160 mm, as long as all six suspension points are used



### Rockfon Eclipse Rectangle 2360 x 1160 mm

When a light fixture or beam light is installed (max. 5 kg), all six suspension points should be used (see page 6).

#### A: Downlight (or similar service) integrated with yoke

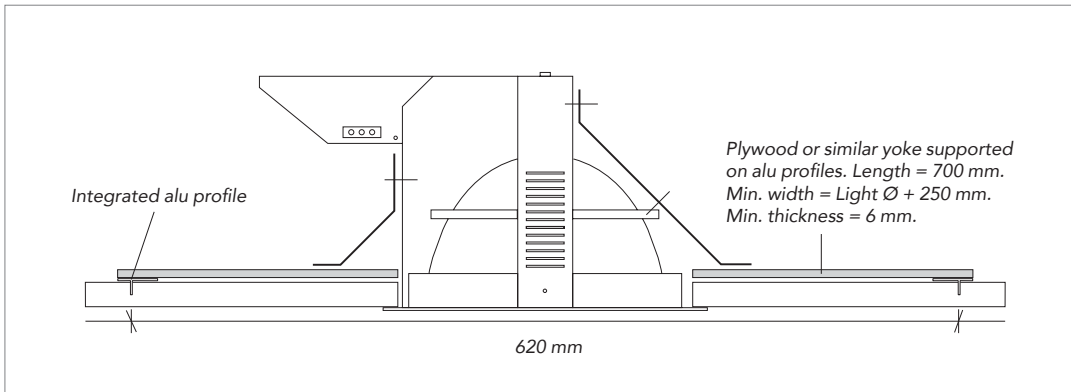

This solution is applicable for lights (or other services) and yokes weighing 5 kg. Cut a hole in the island and centre the yoke to match the size and shape of the light. If using “out of balance” light (as shown), ensure overhang is in line with the length of the yoke. Fit light into the island and yoke.

#### B: Downlight (or similar service) integrated with support arms

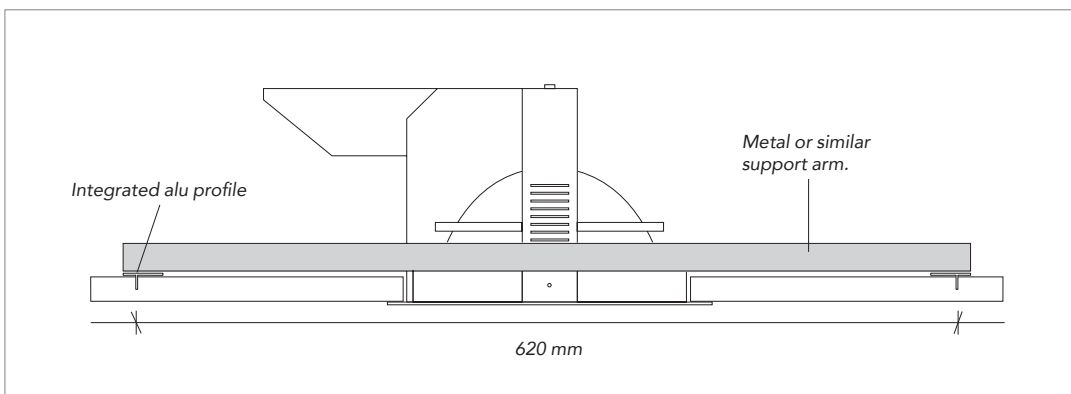

This solution is applicable for lights (or other services) weighing 5 kg. Support the light fixture using two support arms, that are resting on the integrated alu profiles. Cut a hole in the island to match the size and shape of the light fixture. If using “out of balance” light (as shown), ensure overhang is in line with the support arms.

## Rockfon Eclipse® Colour with protective film light hole cutting

Drilling the hole in an anti-clockwise direction, opposite rotation will tear off the protective film.

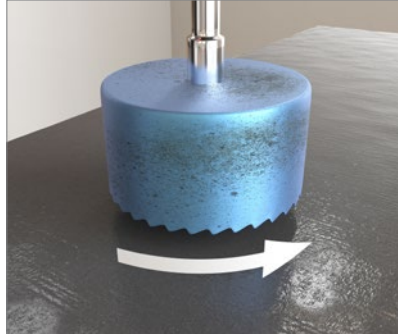

Dust may come up during the drilling process, but delicate surfaces are protected.

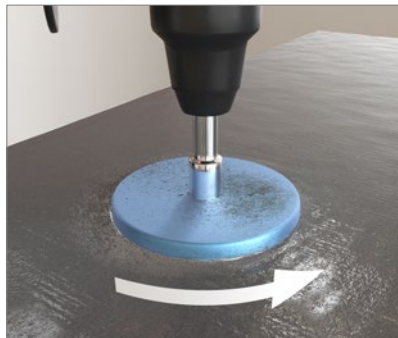

Install the light housing with the mounting clip, then install the downlight while maintaining the protective film during installation.



Make the cutout manually using a template and a paper cutter without removing the protective film.

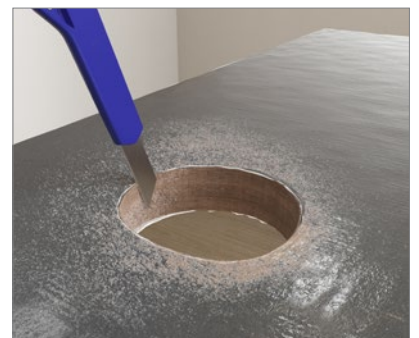
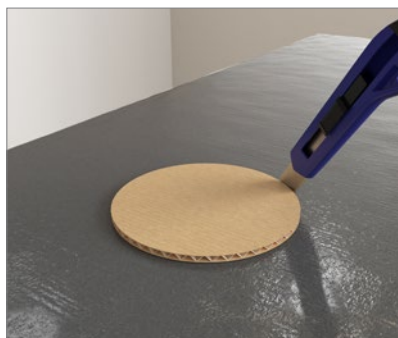

## Rockfon Eclipse edge repair filler

Edge repair filler for making good accidental edge damage caused during on-site handling or installation.

This filler was developed to repair dents or small holes, up to 15mm diameter, or scratches that may be caused during product mishandling.

The fillers structure and colour is identical to factory applied Rockfon Eclipse and Rockfon Contour edge paint, making site repairs virtually undetectable.

It is easy to apply and fast drying.



## Tools

Rockfon has developed specific tools that are available on [cee.rockfon.international](http://cee.rockfon.international)

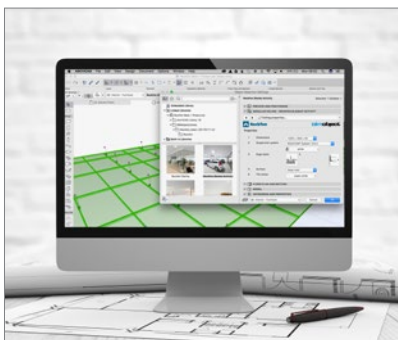

Visit our online CAD Library or BIM portal to assist you in your project design.

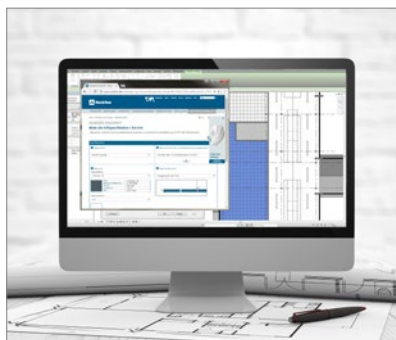

Generate specification texts for our products on our website.

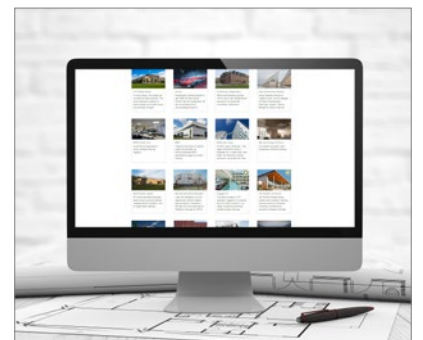

Explore our vast library of reference projects on our website.

# Sounds Beautiful

