

INSTALLATION GUIDE

# Rockfon® System Contour™ Baffle



**A-edge**

## Frameless baffle system

- Vertical free hanging acoustic baffle
- Quick and easy installation
- Ideal solution when a suspended ceiling for technical or aesthetical reasons is not suitable
- A variety of shapes and sizes

**Sounds Beautiful**

## Description

**Rockfon System Contour Baffle** is a frameless acoustic baffle system consisting of a 50 mm stone wool baffles and metal wire suspension kit. Both sides of the baffle are covered with an aesthetically pleasing, smooth, matt white mineral fleece. The edges are painted and two fixing points have been embedded for easy and safe installation of the baffle.

Rockfon Contour® is suspended by an adjustable metal wire that can be fixed to the soffit or below an existing grid. The use of rigid hangers is prohibited.

This system is ideal in rooms and buildings where the use of a traditional suspended ceiling is technically not appropriate (e.g. where the principles of thermal mass is used in building design) or aesthetically unappealing (e.g. where skylight or tall windows are installed). It provides a flexible solution for the provision of noise

absorption in new constructions and is ideally suited for room acoustic improvements in existing buildings. An assortment of modular shapes and sizes lets you design with fascinating waves or playful patterns.

It is quick and easy to install.

### Restrictions

Due to the risk of corrosion, the suspension accessories of Rockfon System Contour Baffle should not be used in swimming pools or outdoor environments. Do not mount Rockfon Contour in static or rigid fixation or areas subjected to wind load and drafts. Always use the recommended wire suspension kit.

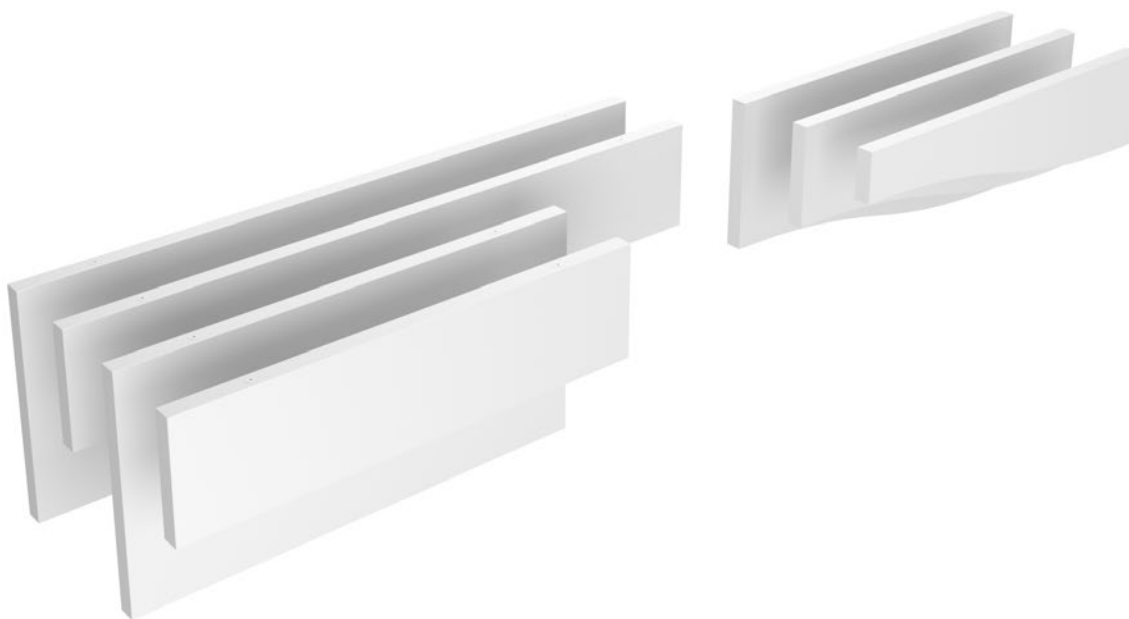

Steel screw eyes delivered along with the baffle.  
Diameter: 4,85 mm

Pre-embedded plugs for easy and safe installation.



Rockfon has two suspension kits variants with 1500 mm adjustable metal wire and safe attachment hook.  
1. Contour Classic suspension kit.  
2. Contour Design suspension kit.

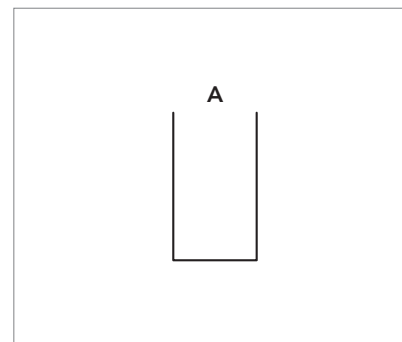

Rockfon Contour A edge.

## System components

Rockfon Contour is available in the following dimensions:

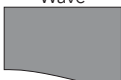
Rockfon Contour				
Shapes	Dimensions W x H x D (mm)	Baffle/box	Weight (kg/baffle)*	Screw eyes included in the box (1 bag = 8 screw eyes)
Rectangle 	1200 x 300 x 50	8	2,20	2 bags
	1200 x 600 x 50	4	4,30	1 bag
	1800 x 300 x 50	8	3,20	2 bags
	1800 x 600 x 50	4	6,50	1 bag
Wave 	1200 x 150/300 x 50	8	1,60	2 bags
	1200 x 300/450 x 50	4	2,70	1 bag
	1200 x 450/600 x 50	4	3,80	1 bag

\*exc. the weight of anchor and screws: 30 grams/baffle in the box.

Rockfon Contour should be installed using one of the Rockfon suspension kits, consisting of a 1500 mm long metal wire and an adjustable safety attachment hook. Once the screw eye is secured in the pre-embedded plug in the baffle, the hook on the wire is attached to the screw eye.

Rockfon offers two suspension kits; the Classic Solution and the Design Solution, which is optimal for projects where aesthetics are important.

Make sure to order adequate amount of preferred kits apart from the Contour baffles.

Rockfon Contour Suspension Kits – Classic solution	
Units/box	Weight (kg/box)
2 sets of 6	0,52

The Rockfon Contour Classic Suspension Kit can be secured using a standard setscrew that corresponds to the relevant soffit material (e.g. concrete, wood...).

Rockfon Contour Suspension Kits – Design solution	
Units/box	Weight (kg/box)
2 sets of 6	0,66

The Rockfon Contour Design Suspension Kit features a refined cylindrical capping that hides the screw thread and provides a visually appealing finish. It can be fastened using a standard set screw that corresponds to the relevant soffit material. Alternatively an M6 thread wire can be used.

Rockfon can only guarantee the integrity of the Rockfon System Contour Baffle if it is installed with Rockfon screw eyes that come with the baffle.

### Baffle - A Edge

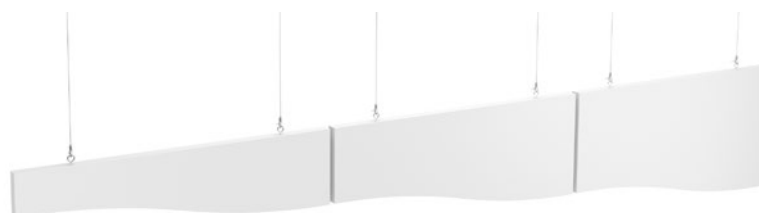

### Accessories

1. Suspension kits – Classic solution



2. Suspension kits – Design solution



3. Spacer



## Performance



### System load bearing capacity

The maximum load per metal wire is 5 kg.



### Corrosion resistance

Due to the risk of corrosion, the suspension accessories of Rockfon System Contour Baffle should not be used in swimming pools or outdoor environments.

## Compatible accessories

Only Rockfon Contour with premounted fixing plugs can be used in Rockfon System Contour Baffle.

Rockfon does not advise to install Rockfon Contour baffles with edges against each other. A min. gap of 6 mm between 2 baffles is advised.

To ensure even distance between Contour baffles it is mandatory to use the Rockfon Contour Baffle spacer accessory (2 pcs per vertical side, except for the short edge (150 mm) of Wave 1200 x 150/300 x 50 mm variation). This will create an aesthetically pleasing 6 mm gap between the baffles.

The Contour Baffle Spacer is placed along the center line of the edge on one of the edges facing a adjacent baffle. Each placed equal distance to the upper and lower corners.

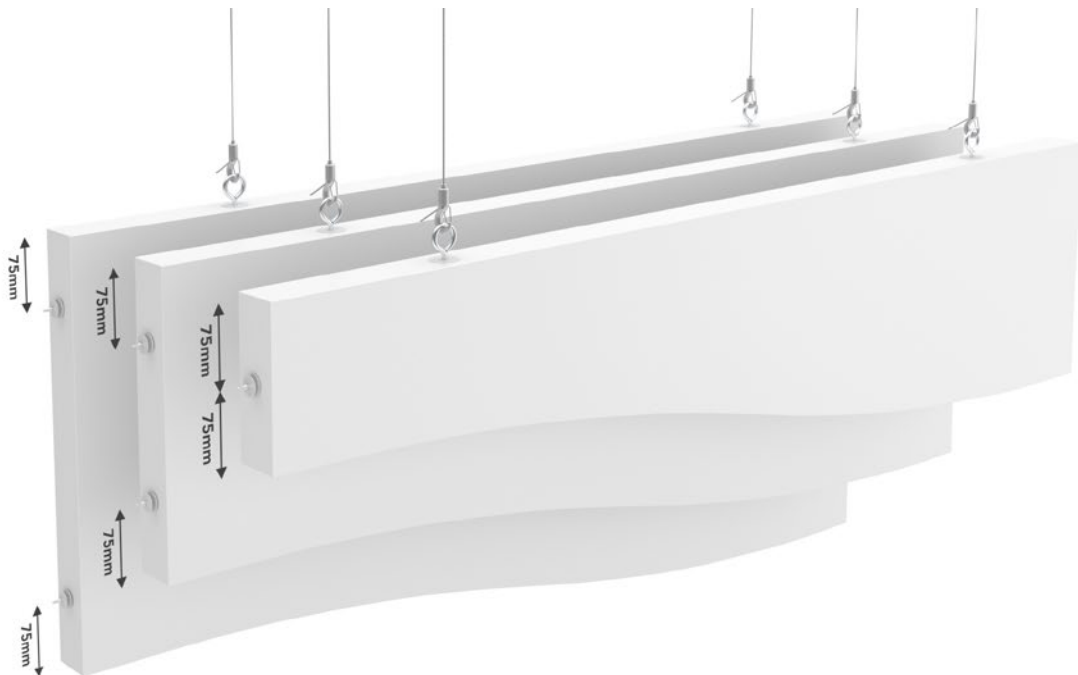

## Installation

### Fixing screw eyes to the baffle

Rockfon Contour is equipped with two plugs inserted 200 mm from the edge of the baffle. The screw eyes should be inserted carefully in the white plugs. Insert the screw eye till the thread is no longer visible and then give it another half turn.

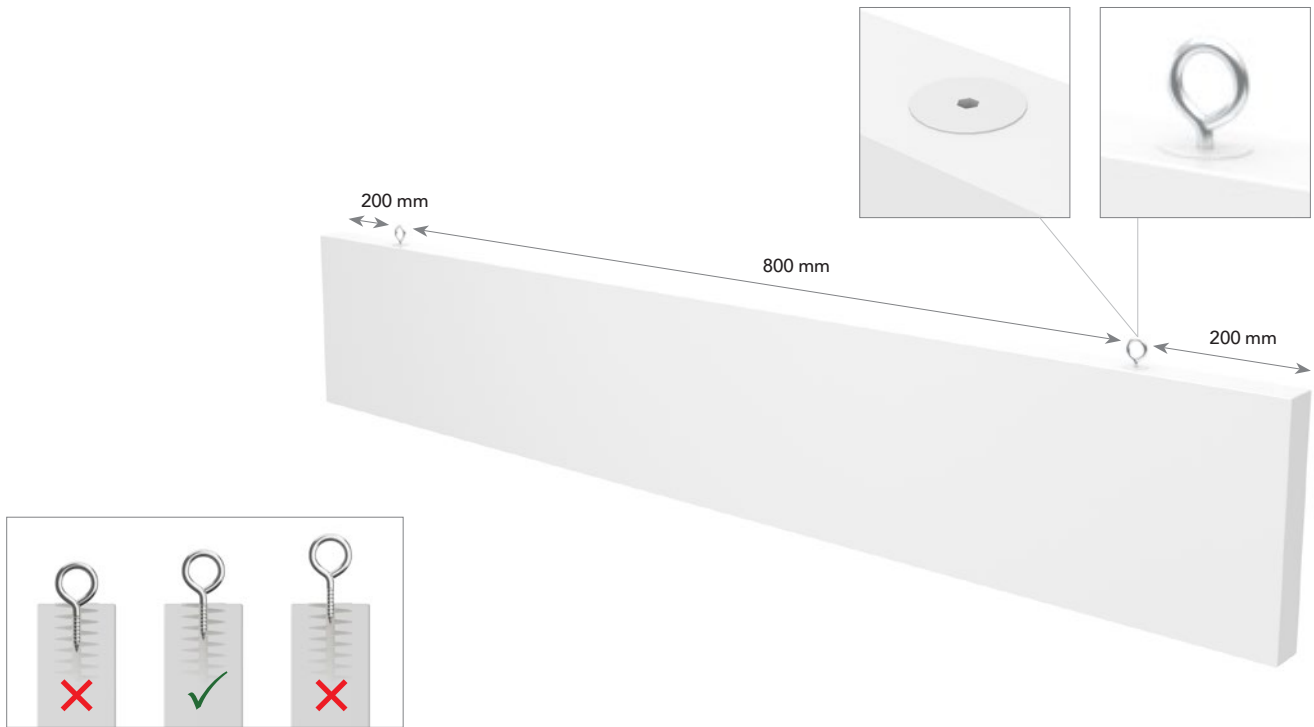

### Connecting Rockfon System Contour Baffle to the soffit

Ensure that the soffit is solid and has a load bearing capacity of at least 16 kg m<sup>2</sup>.

Drill holes and attach the Classic or Design suspension kit to the soffit. Slide the wire into the hook. The system locks automatically providing maximum safety. Ensure all hooks are correctly attached before raising the baffle to the required height. The maximum load per wire is 5 kg.

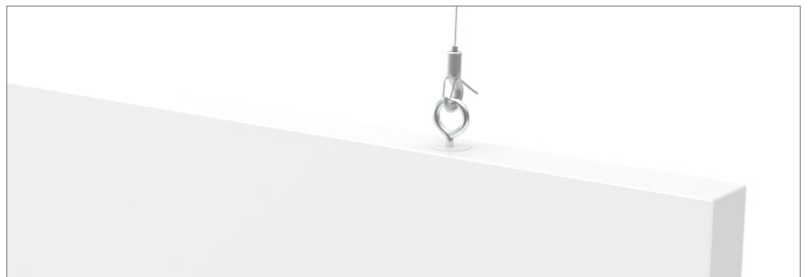

### Levelling

Adjust the height by using a level or laser:

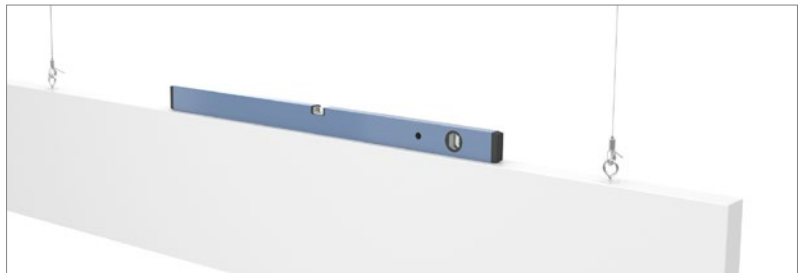

### Installing Rockfon System Contour Baffle below an existing suspended ceiling

It is possible to fix Rockfon System Contour Baffle to existing T24 grids with our Chicago Metallic sign hanger combined with the Rockfon Contour design suspension kit (Max. 5kg/clip). Always install with the recommended wire suspension. Rigid or static hangers are prohibit.



## General installation recommendations

### Baffles

It is recommended to use clean nitrile or PU coated gloves when installing Rockfon baffles in order to avoid finger prints and pollution of the surface.

For an optimised working environment, we recommend that installers always observe common workplace practices and follow the installation advise as shown on our packaging.

## Rockfon Contour® edge repair filler

Edge repair filler for repairing accidental edge damage caused during on-site handling or installation.

This filler was developed to repair dents or small holes, up to 15 mm diameter, or scratches that may be caused during product mishandling.

The fillers, structure and colour is identical to factory applied Rockfon Eclipse and Rockfon Contour edge paint, making site repairs virtually undetectable.

It is easy to apply and fast drying.



## Tools

Rockfon has developed specific tools that are available on [cee.rockfon.international](http://cee.rockfon.international)

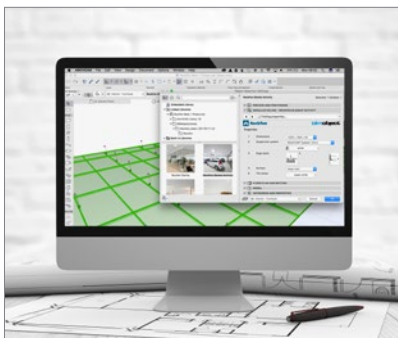

Visit our online CAD Library or BIM portal to assist you in your project design.

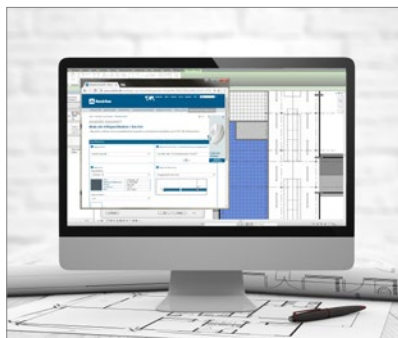

Generate specification texts for our products on our website.

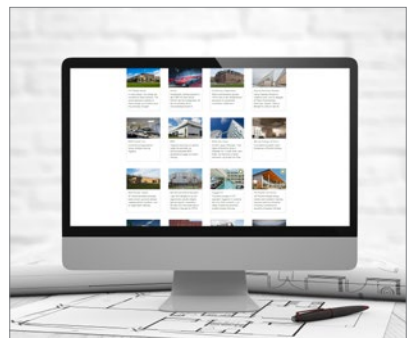

Explore our vast library of reference projects on our website.

# Sounds Beautiful

