

Rockfon® Curvgrid™ Two-directional

Features & Benefits

- Create dramatic arch ceilings, waves, vaults and islands for interior spaces
- Curved and straight main tees connect with straight cross tees and perimeter trim to form 24" x 24" standard ceiling modules
- Fully visible main tees, cross tees and perimeter trim
- Primary Carrier support for tees and trim requires fewer hanger wires
- Use with or without flexible infill panels

Applications

- Auditoriums
- Lobbies
- Retail
- Schools
- Hospitality

*Project – Bradley Central High School Fine Arts Center in Cleveland, TN
Product – Rockfon® Curvgrid™ Two-directional*

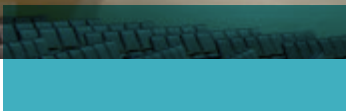
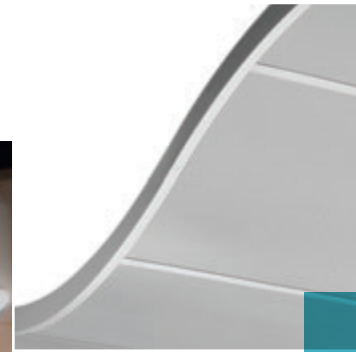

Rockfon® Curvgrid™ Two-directional

LEED® V4 HIGHLIGHTS

Materials and Resources (MR)

Waste Management Planning	✓
Interiors Life Cycle Impact Reduction	✓
Environmental Product Declarations	✓
Sourcing of Raw Materials	✓
Material Ingredients	-
Waste Management	✓

Indoor Environmental Quality (EQ)

Low-Emitting Materials	✓
Interior Lighting	-
Acoustic Performance	✓

Recycled Content: up to 85%

Product Code Example: **252574:CRVG:CTDP:2424:R:01:.32AL**

Family Number & Name:
252574 Curvgrid™
Metal Panel

Dimensions:
24" x 24"
Panel

Color: White

252574:CRVG: **CTDP:** **2424:** **R:** **01:** **.32AL**

Detail:
Two-directional

Perforation Pattern:
11.1%
Open Area

Material:
0.032" Aluminum

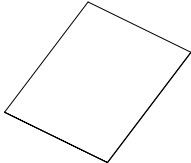
Family Number & Name	Detail	Dimensions	Perforations* (% open area)	Material	NRC	Fire Class	Light Reflectance	Low VOC
252574:CRVG: Curvgrid™ Metal Panel	CTDP: Two-directional 	2424: 24" x 24" Panel CUST: **	Standard SOLID: 0% D: 16.2% E: 20.8% J: 58.2% Q: 70% R: 11.1% V: 4.9% AA: 2.5% <u>Premium</u> see footnote * <u>Custom</u> CUST: **	.32AL: 0.032" Aluminum	up to 0.90***	A	-	✓

* For graphic representations of the perforation options, see the Rockfon Perforations Brochure.

** For designer specified Dimensions or Perforation, contact Rockfon Technical Services at 1-800-323-7164 or techservices@rockfon.com.

*** NRC values are dependent on perforation patterns, plenum depth and acoustical backer options. Contact Rockfon Technical Services for more information at 1-800-323-7164 or techservices@rockfon.com.

Note:

- Curvgrid Two-directional metal lay-in panels are held in place with clips - see Curvgrid Two-directional details.
- See Curvgrid Two-directional Suspension chart for minimum radius information.
- Acoutex™ Backer standard with perforated panel.
- Perforated panel available without Acoutex.

Choose from the above product options to build your product code

Family Number & Name	Detail	Standard Dimensions or Custom Dimensions	Perforation	Color*	Material
252574:CRVG:	CTDP:				.32AL

* Select one of our many color options, located on page 3

Standard colors:



01 White



08 Black



44 Satin Silver



888
Winchester
Grey

Premium colors:



Color-all



Custom
(color match)

Metallic colors:



795
Champagne
Metallic



796
Beige
Metallic



797
Iron Glimmer
Metallic



798
Copper
Metallic

Metalwood® Woodgrain Finishes[▲]:



650R
Maple**



651R
Cherry**



652R
Pumpkin
Maple**



653R Oak**



654R Karri**



655R
Bamboo**

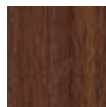

656R
Walnut**



401 Maple*



402 Oak*



403 Cherry*



404 Pumpkin
Maple*



405 Karri*



406 Walnut*

Woodscenes® Painted Finishes[†]:



800
Lazy Maple



801
Aged Teak



803
Burnished
Cherry



804
Sleek Cherry



805
Weathered Oak

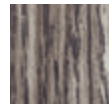

806
Barnwood
Grey

* Coordinating solid color to match Metalwood Woodgrain Finishes.

** Metalwood Woodgrain Finishes not available for Rockfon Curvgrid Suspension, CurvTrim or panels wider than 24"; use coordinating solid color. See footnote *.

▲ Metalwood Woodgrain Finishes are a 0.008" vinyl laminate that replicate real wood; variations in color and pattern will occur. For final panel thickness information contact Rockfon Technical Services at 1-800-323-7164 or techservices@rockfon.com. For interior use only.

† Woodscenes Painted Finishes are a decorative powder coat finish that replicate real wood; variations in color and pattern will occur.

Note:

- Metalwood and Woodscenes grain direction is parallel to the length of the panel.

- See rockfon.com for more information on color options.

Colors shown are reproduced as close as possible to actual product color within the limitations of printing technology. Color chips are available upon request and should be reviewed before making a final selection. Variations in color matches of system components to ceiling panels can result from slight differences in texture, room lighting, painting process and subjectivity of observers.

Curvgrid Two-directional Suspension

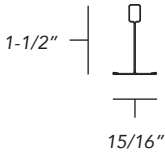
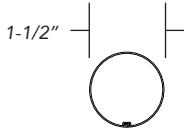
Detail	Product Number	Length	Slotting	Spacing	Finish
Curvgrid Suspension Tee (Convex, Concave and Straight)*					
	Main Tee** (Main Runner) Cross Tee**	Main Tee 144" - Standard Cross Tee 24" - Standard	Main Tee 24" O.C. - Standard Cross Tee no slotting	Main Tee 24" O.C. - Standard (Custom Spacing available) Cross Tee 24" O.C. - Standard	see footnote ***
Primary Carrier					
	249651 481.024.008	as required per design	-	48" O.C. Standard	08 Black

* Minimum convex and concave suspension radius is 36".

** Curvgrid Suspension Tee made to order per design. For ordering information, contact Rockfon Technical Services at 1-800-323-7164 or techservices@rockfon.com.

*** Available in Standard, Premium, Metallic and Woodscenes finishes.

CurvTrim Perimeter Trim

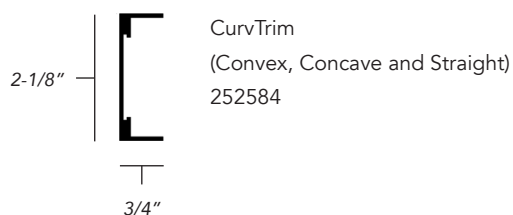

Note:

- 36" minimum convex and concave radius.
- Available in Standard, Premium, Metallic and Woodscenes finishes.

Curvgrid Two-directional System Accessories

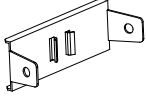

Splice Plate
(Curvgrid Main Tee)
(galvanized)
250327
436.00

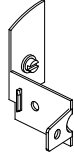

Grid Attachment Clip
(Curvgrid to CurvTrim)
(galvanized)
249362
433.00

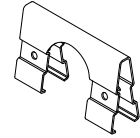

Clip
(Primary Carrier
to Curvgrid)
(galvanized)
249365
442.00

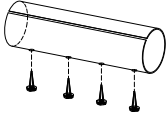

Splice
(Primary Carrier)
(galvanized)
249367
444.00



Clip
(Primary Carrier
to Hanger Wire)
(galvanized)
250328
441.00

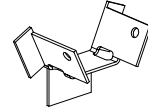

Clip
(Primary Carrier
to CurvTrim)
(galvanized)
249366
443.00

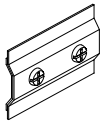

Splice Plate
(CurvTrim)
(galvanized)
249363
434.00

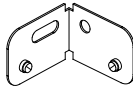

Splice Plate
(CurvTrim
Outside Corner)
(galvanized)
249360
429.00

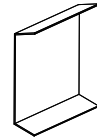

Hold Down Insert
(steel - prefinished)
249364
437.00

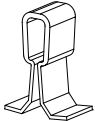

Hold Down Clip
(Clear Plastic)
250382
8886.00

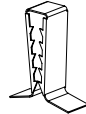

Hold Down Clip
(metal - black oxide)
264683
63.26.200

Note:
For panels with maximum perforation
percent (%) open area.

Note:
For panels with minimum perforation
percent (%) open area.

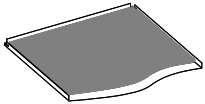

Acoustical Pads
(Poly-Wrapped Fiberglass)
(Black Plastic Wrap)

24" x 24" x 1" 250505
58.01.059.008

24" x 24" x 1-1/2" 250509
58.01.064.008

24" x 48" x 1" 250507
58.01.061.008

24" x 48" x 1-1/2" 250508
58.01.063.008

Curvgrid Standard Details

Curvgrid Tee to CurvTrim with Grid Attachment Clip

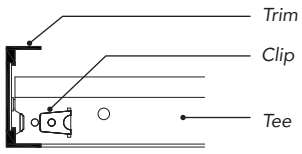

CurvTrim Splice Plate Connection

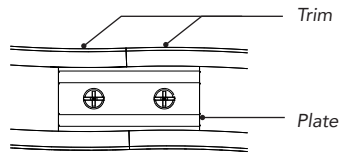

Curvgrid Tee Splice Plate Connection

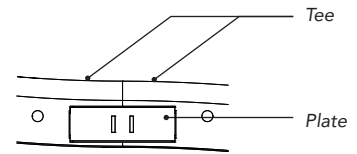

Curvgrid Two-directional Details

Panel at CurvTrim with Hold Down Insert

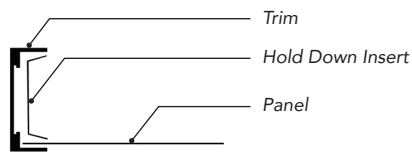

Panel at Curvgrid Tee with Hold Down Clip - Clear

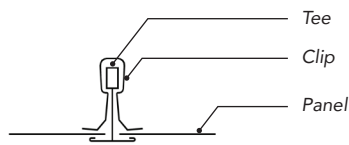

Panel at Curvgrid Tee with Hold Down Clip

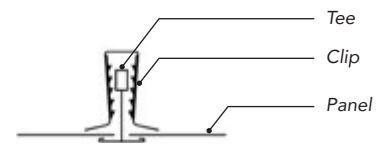

Curvgrid Design Layout Examples

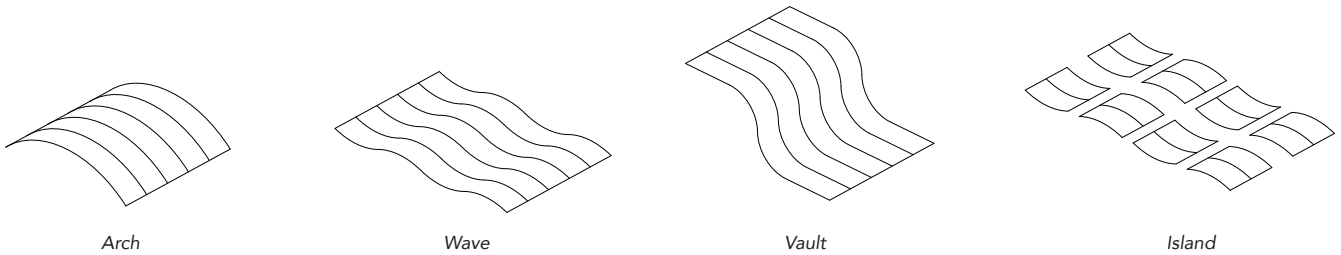

Curvgrid Two-directional System Detail

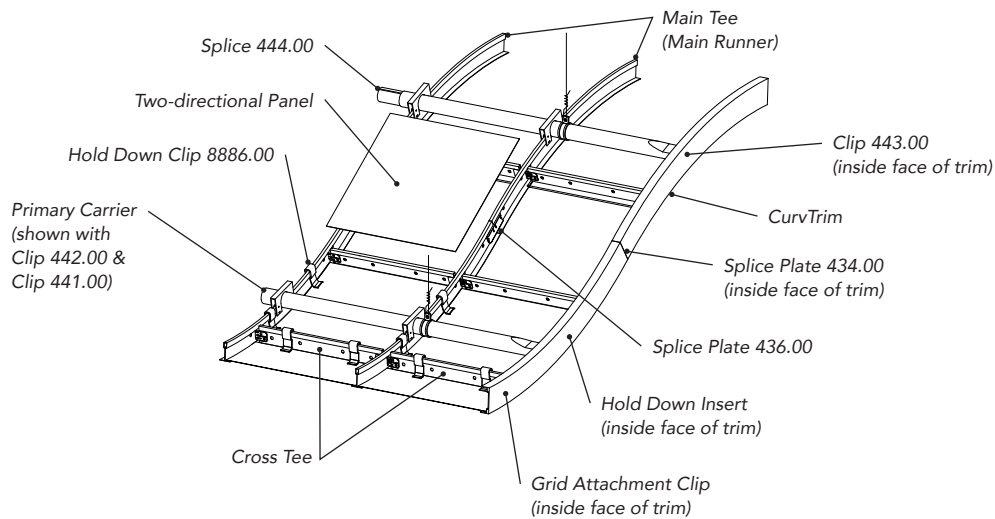

Curvgrid Two-directional System Detail Notes:
 - See rockfon.com for more product information.



Material

0.032" Aluminum



Fire Performance

Surface burning characteristics:
UL723 (ASTM E84)
Flame Spread Index: 0
Smoke Developed Index
(UL Labeled): 0



Hygiene

Metal provides no sustenance
to microorganisms



Warranty

1-Year Limited
Product Warranty.
See rockfon.com



Environment

- Up to 85% recycled content
- 100% locally recyclable



Cleaning

- Damp Cloth

080819

Rockfon

4849 S. Austin Ave.
Chicago, IL 60638 USA