

Rockfon[®] Intaline[™] Round Base

Features & Benefits

- Metal baffle, plenum masking open ceiling system for interior spaces
- 100% random access to plenum
- Tee grid based system for ease of installation
- Variable baffle spacing

Applications

- Airports
- Passenger Terminals
- Corridors
- Assembly Halls
- Convention Centers



*Project – O'Hare International Airport's Terminal 5 in Chicago, IL
Product – Rockfon[®] Intaline[™] Round-Base Metal Baffles*

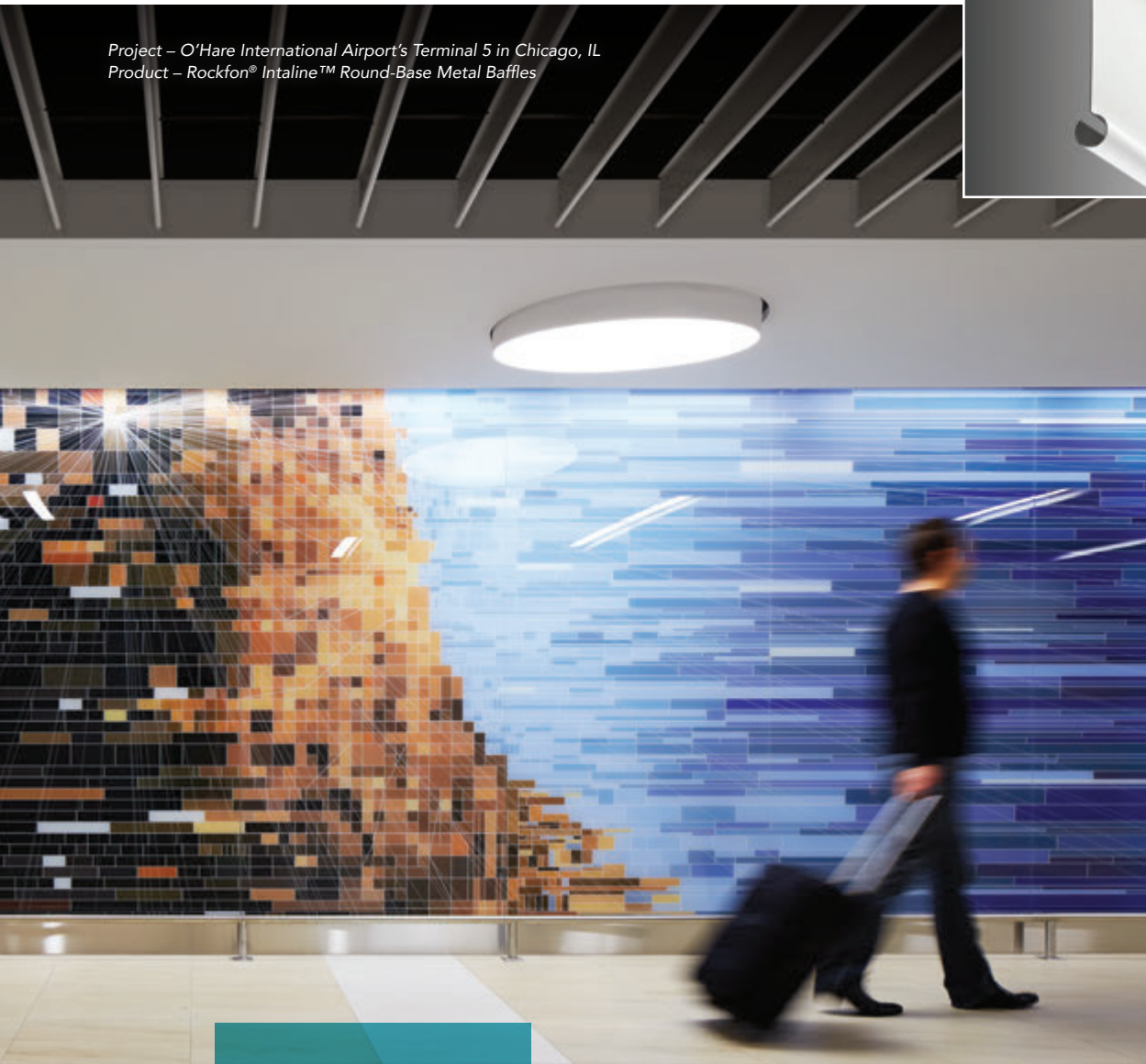

Rockfon® Intaline™ Round Base

LEED® V4 HIGHLIGHTS

Materials and Resources (MR)

- Waste Management Planning ✓
- Interiors Life Cycle Impact Reduction ✓
- Environmental Product Declarations ✓
- Sourcing of Raw Materials ✓
- Material Ingredients -
- Waste Management ✓

Indoor Environmental Quality (EQ)

- Low-Emitting Materials ✓
- Interior Lighting -
- Acoustic Performance -

Recycled Content: up to 85%

Product Code Example: **252569:INTR:IRB:8:798:AL**

Family Number & Name:

252569 Intaline™
Metal Baffle

Dimension:
8"

Material:
0.032" Aluminum

252569:INTR: IRB: 8: 798: AL

Detail: Round Base
Color: Copper Metallic

Family Number & Name	Detail	Dimension	Material	NRC	Fire Class	Light Reflectance	Low VOC
252569:INTR: Intaline™ Metal Baffle	<p>IRB: Round Base</p>	<p>6: 6" 8: 8" 10: 10"</p>	AL: 0.032" Aluminum	-	A	-	✓

Note:

- Standard baffle length 12'.
- Special length baffles available from 2' to 16'.
- Contact Rockfon Technical Services for ordering information at 1-800-323-7164 or techservices@rockfon.com.

Choose from the above product options to build your product code

Family Number & Name	Detail	Dimension	Color*	Material
252569:INTR:	IRB:			AL

* Select one of our many color options, located on page 3

Note:

- Baffle surface finish - Smooth, painted 360°.

Standard colors:



01 White



08 Black



44 Satin Silver



888
Winchester
Grey

Premium colors:



Color-all



Custom
(color match)

Metallic colors:

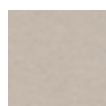

795
Champagne
Metallic



796
Beige
Metallic



797
Iron Glimmer
Metallic



798
Copper
Metallic

Metalwood® Woodgrain Finishes:
(Shown for reference only - See footnote**)



650R
Maple**



651R
Cherry**



652R
Pumpkin
Maple**



653R Oak**



654R Karri**



655R
Bamboo**

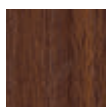

656R
Walnut**



401 Maple*



402 Oak*



403 Cherry*



404 Pumpkin
Maple*



405 Karri*



406 Walnut*

Woodscenes® Painted Finishes†:



800
Lazy Maple



801
Aged Teak



803
Burnished
Cherry



804
Sleek Cherry



805
Weathered Oak

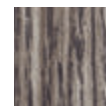

806
Barnwood
Grey

* Coordinating solid color to match Metalwood Woodgrain Finishes.

** Metalwood Woodgrain Finishes not available for Rockfon Intaline; use coordinating solid color. See footnote *.

† Woodscenes Painted Finishes are a decorative powder coat finish that replicate real wood; variations in color and pattern will occur - finished on both sides.

Note:

- Reflective/anodized finishes on one side only.
- Woodscenes grain direction is parallel to the length of the panel.
- See rockfon.com for more information on color options.

Colors shown are reproduced as close as possible to actual product color within the limitations of printing technology. Color chips are available upon request and should be reviewed before making a final selection. Variations in color matches of system components to ceiling panels can result from slight differences in texture, room lighting, painting process and subjectivity of observers.

Intaline Round Base Suspension

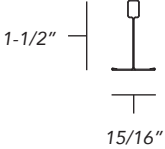
Detail	Product Number	Duty Rating	Length	Slotting	Spacing	Baffle Spacing	Finish
Main Runner*							
 1-1/2"	252601 C1811M	Intermediate Duty (ID)	144"	48" O.C.	48" O.C.	variable	black web & capping - standard**
	252601 C1800M08B	Heavy Duty (HD)					
Cross Tee (Stab-End)*							
	252604 C1804M08B	NA ¹	48"	no slots	48" O.C.	-	black web & capping - standard**

* Suspension system for Intaline based on 1800 suspension grid system. Reference ICC-ES Evaluation Report ESR-2631 for testing information.

** Available in Standard, Premium, Metallic and Woodscenes finishes.

¹ Not Applicable - Duty rating applies only to main runners with a 4-ft span.

Intaline Perimeter Trim

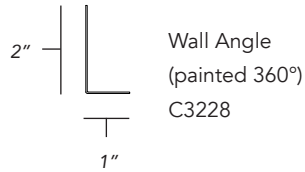
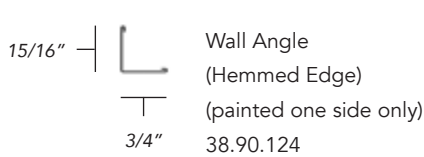

Note:

- Wall Angle available in Standard, Premium, Metallic and Woodscenes finishes.

Intaline Round Base System Accessories

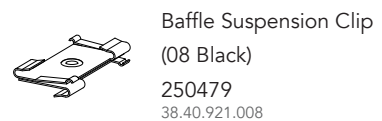
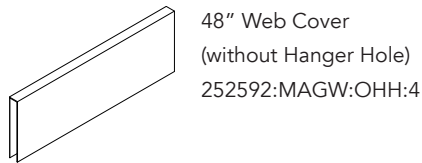
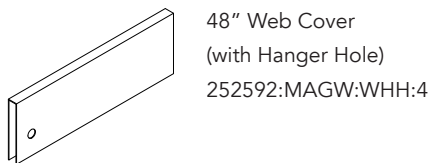

Note:

- Web Covers available in Standard, Premium, Metallic and Woodscenes finishes.

Note:

- Suspension Clip swivels for angled layouts.

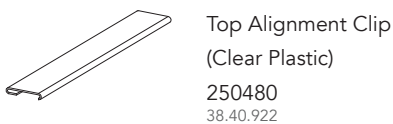

Intaline Standard Details

Baffle Parallel To Wall

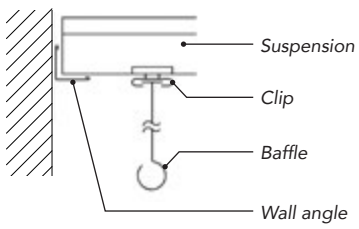

Baffle Perpendicular To Wall

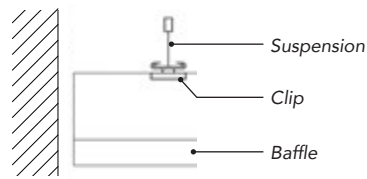

Baffle Alignment

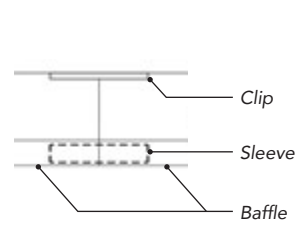

Web Cover

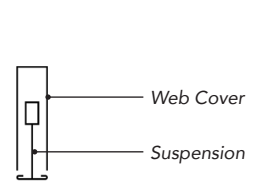

Intaline Round Base System Detail

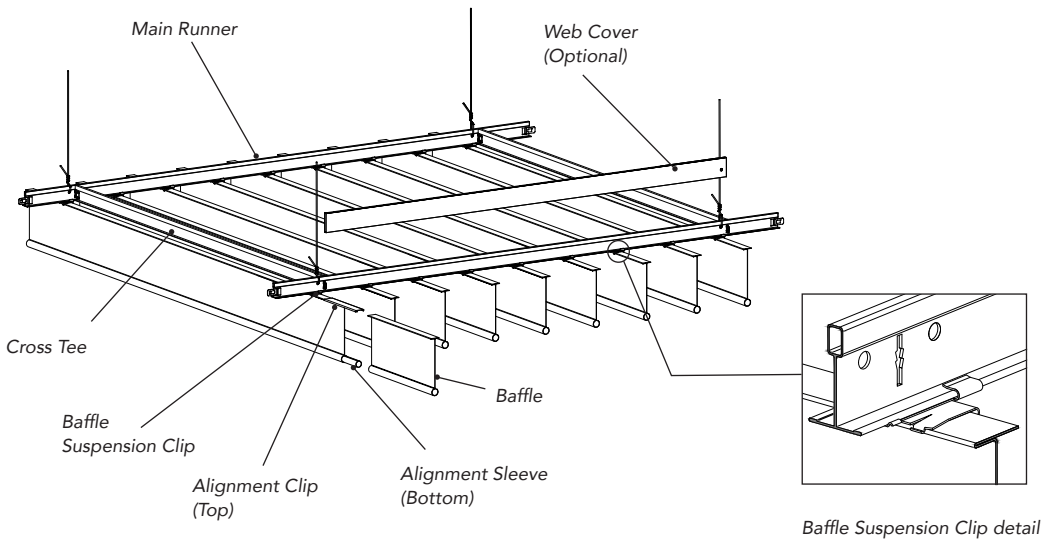

Intaline Round Base System Detail Notes:
 - See rockfon.com for more product information.

Component Load Test Data

Allowable Load per ASTM C635				
		Hanger Spacing		
Main Runner	Length	4'	5'	6'
1811	12'	Intermediate Duty		4.0
Cross Tee	Length	2'	4'	
1804	2'	14.1	Intermediate Duty	

To convert data into lb/ft², divide on center spacing of component into lb/ft.



Material

0.032" Aluminum



Fire Performance

Surface burning characteristics:
UL723 (ASTM E84)
Flame Spread Index: 0
Smoke Developed Index
(UL Labeled): 0



Hygiene

Metal provides no sustenance
to microorganisms



Warranty

1-Year Limited
Product Warranty.
See rockfon.com



Environment

- Up to 85% recycled content
- 100% locally recyclable



Cleaning

- Damp Cloth

080819

Rockfon

4849 S. Austin Ave.
Chicago, IL 60638 USA