

Rockfon® Infinity™ Z

Features & Benefits

- Finish edge trim with knife edge detail for interior suspended ceiling perimeters
- Available pre-finished in straight lengths with square cut or mitered ends
- Variety of finish options available
- Integrates with Chicago Metallic® Ceiling Suspension, Rockfon Stone Wool Ceiling Panels, Rockfon Metal Ceiling systems and industry standard T-Bar grid

Applications

- Ceiling projections
- Free-floating islands
- Light covers

*Project – 90 Elgin in Ottawa, Ontario
Product – Rockfon® Infinity™ Z*

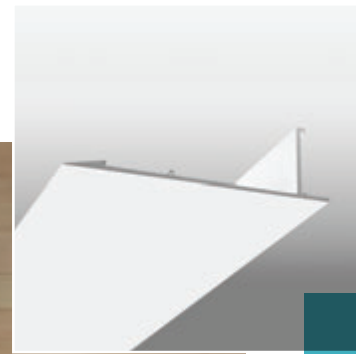

Rockfon® Infinity™ Z

Product Code Example: **252565:INFE:RAZ:6:44:AL**

LEED® V4 HIGHLIGHTS

Materials and Resources (MR)

- Waste Management Planning ✓
- Interiors Life Cycle Impact Reduction ✓
- Environmental Product Declarations ✓
- Sourcing of Raw Materials ✓
- Material Ingredients -
- Waste Management ✓

Indoor Environmental Quality (EQ)

- Low-Emitting Materials ✓
- Interior Lighting -
- Acoustic Performance -

Recycled Content: up to 85%

Family Number & Name: 252565 Infinity™ Straight Face Dimension: 6" Material: Extruded Aluminum

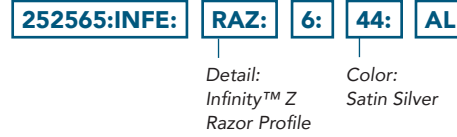

Family Number & Name	Detail	Face Dimension	Material	NRC	Fire Class	Light Reflectance	Low VOC
252565:INFE: Infinity™ Straight	<p>RAZ: Infinity™ Z Razor Profile</p>	6: 6"	AL: Extruded Aluminum	-	A	-	✓

- Note:
- Available in straight, standard 12' lengths or designer specified lengths.
 - Square cut ends standard. Factory-cut miters available.
 - Unpainted, galvanized Grid Clip and Splice Plate included with trim.

Choose from the above product options to build your product code

Family Number & Name	Detail	Face Dimension	Color*	Material
252565:INFE:	RAZ:	6:		AL

* Select one of our many color options, located on page 3

- Note:
- Trim painted on outer surface or 360°.

Standard colors:



01 White



08 Black



44 Satin Silver



888
Winchester
Grey

Premium colors:



Color-all



Custom
(color match)

Metallic colors:

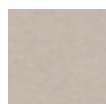

795
Champagne
Metallic



796
Beige
Metallic



797
Iron Glimmer
Metallic



798
Copper
Metallic

Metalwood® Woodgrain Finishes:
(Shown for reference only - See footnote **)



650R
Maple**



651R
Cherry**



652R
Pumpkin
Maple**



653R Oak**



654R Karri**



655R
Bamboo**

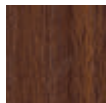

656R
Walnut**



401 Maple*



402 Oak*



403 Cherry*



404 Pumpkin
Maple*



405 Karri*



406 Walnut*

Woodscenes® Painted Finishes†:



800
Lazy Maple



801
Aged Teak



803
Burnished
Cherry



804
Sleek Cherry



805
Weathered Oak



806
Barnwood
Grey

* Coordinating solid color to match Metalwood Woodgrain Finishes.

** Metalwood Woodgrain Finishes not available for Rockfon Infinity; use coordinating solid color. See footnote *.

† Woodscenes Painted Finishes are a decorative powder coat finish that replicate real wood; variations in color and pattern will occur.

Note:

- Woodscenes grain direction is parallel to the length of the trim.

- See rockfon.com for more information on color options.

Colors shown are reproduced as close as possible to actual product color within the limitations of printing technology. Color chips are available upon request and should be reviewed before making a final selection. Variations in color matches of system components to ceiling panels can result from slight differences in texture, room lighting, painting process and subjectivity of observers.

Infinity Z Suspension

Infinity Z Razor Profile is compatible with:

- Chicago Metallic Ceiling Suspension systems
- Rockfon Metal Ceiling suspension systems
- Industry standard T-Bar grid systems

See data sheets of Chicago Metallic Ceiling Suspension systems and Rockfon Metal Ceiling systems for more information.

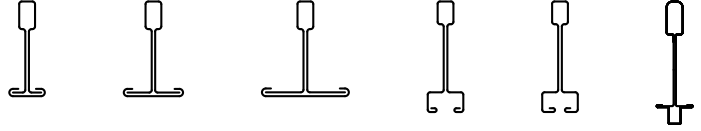

Chicago Metallic Ceiling Suspension Profiles

Infinity Z Accessories

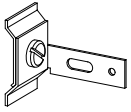

Grid Clip
(suspension to
Infinity Trim)
(Galvanized)
249361
430.00

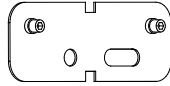

Splice Plate
(for square cut edge)
(Galvanized)
249358
414.00

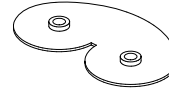

Horizontal Splice Plate
(multi-angle)
(Galvanized)
249368
447.00

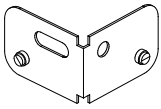

Corner Splice Plate
(Inside Corner)
(Galvanized)
249359
417.00

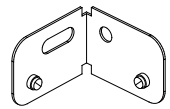

Corner Splice Plate
(Outside Corner)
(Galvanized)
249360
429.00

Infinity Z Standard Detail

Suspension to Infinity Z

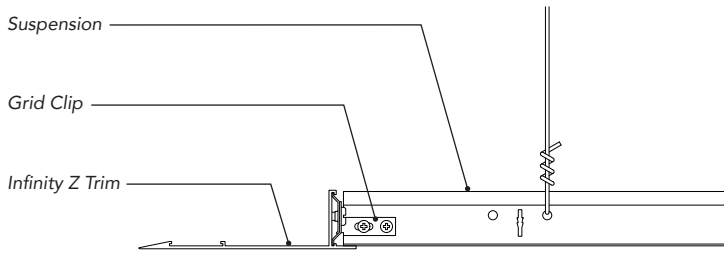

Infinity Z System Details

Suspension to Infinity Z and Splice Plate (square cut edge)

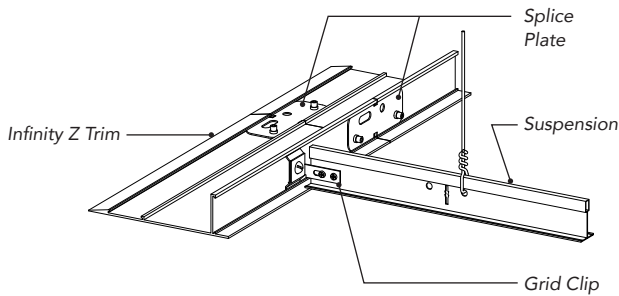

Outside Corner and Inside Corner (Outside Corner similar)

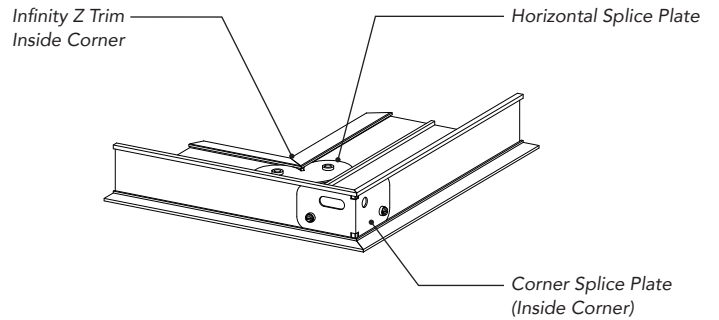

Note:
- Factory mitered corners available: minimum 45° and maximum 135°.

Reflected Ceiling Plan Example

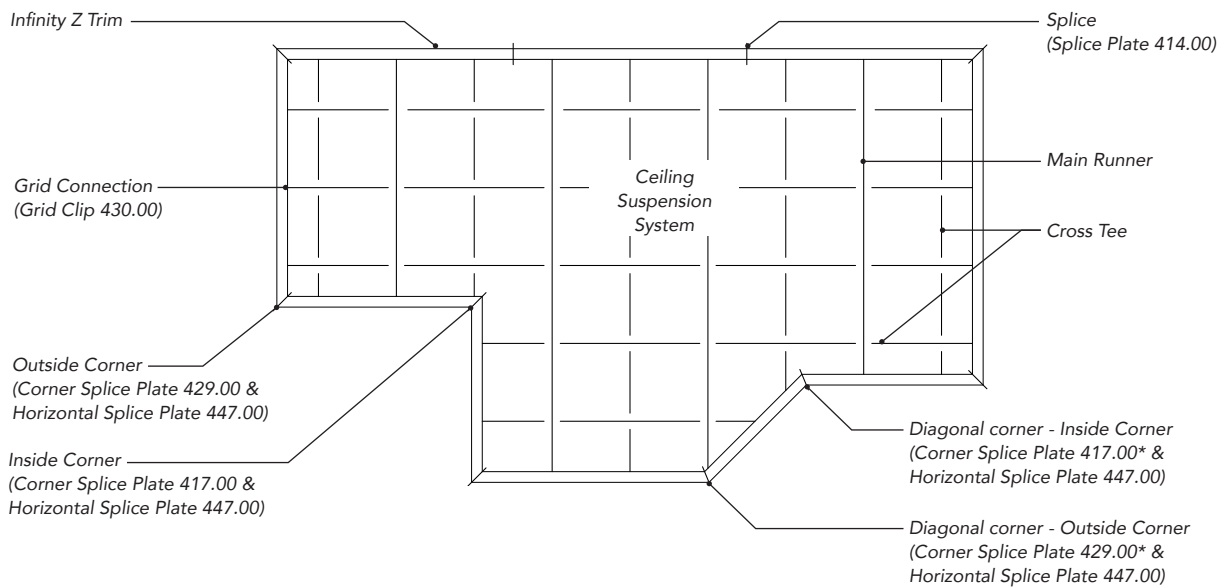

* Field modify Corner Splice Plate to achieve desired angle greater than or less than 90°.



Material

Extruded Aluminum



Fire Performance

Surface burning characteristics:
UL723 (ASTM E84)
Flame Spread Index: 0
Smoke Developed Index
(UL Labeled): 0



Hygiene

Metal provides no sustenance
to microorganisms



Warranty

1-Year Limited
Product Warranty.
See rockfon.com



Environment

- Up to 85% recycled content
- 100% locally recyclable



Cleaning

- Damp Cloth

080819

Rockfon

4849 S. Austin Ave.
Chicago, IL 60638 USA