

Rockfon® System Universal Baffle™

System Description



A framed baffle system

- An ideal acoustic solution where a traditional suspended ceiling is not suitable
- Quick and easy installation
- Available with multiple suspension methods
- A robust acoustic system that protects the baffle edges from damages

Description

Rockfon System Universal Baffle is an acoustic baffle system consisting of a 50 mm stone wool baffle. Its edges are encased in a robust, powder coated galvanised steel frame, which provides multiple installation options. Both sides of the baffle are covered with an aesthetically pleasing, smooth mineral fleece.

Three installation options are available: **Rockfon Baffle Support Track Solution**, the **Rockfon Baffle T24 Solution** and the **Rockfon Baffle Design/Classic Suspension Set Solutions**.

This system is ideal for rooms and buildings where the use of a traditional suspended ceiling is technically not appropriate (e.g. where the principle of thermal mass is used in building design) or a different ceiling design is desired. It is a good and flexible solution to contribute to appropriate room acoustics in new buildings and to make room acoustic improvements in existing buildings. It is easy and fast to install.

Restrictions

Due to the risk of corrosion, the suspension accessories of Rockfon System Universal Baffle should not be used in swimming pools or outdoor environments. Rockfon System Universal Baffle should not be used in areas subjected to wind load and drafts.

Baffle – 4F-edge

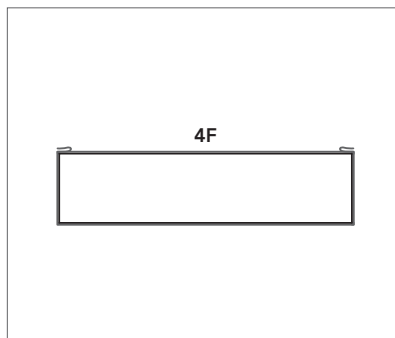

Rockfon Universal Baffle 4F-edge.

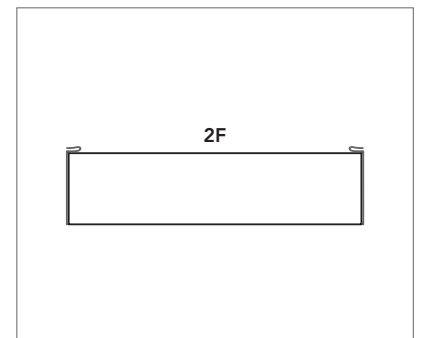

Rockfon Universal Baffle 2F-edge.

Performance



Safety against failure

Class B (EN 13964:2014)



Corrosion resistance

Class B (EN 13964:2014)

Installation

There are 3 different kinds of installation,
providing design and installation flexibility:

1	Rockfon Baffle Support Track Solution	4
2	Rockfon Baffle T24 Solution	8
3	Rockfon Baffle Design/Classic Suspension Set Solutions	13

1. Rockfon Baffle Support Track Solution



Rockfon Universal Baffles in parallel rows – in Support Tracks.

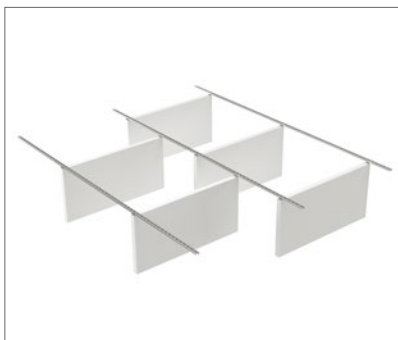

Rockfon Baffle Support Track Solution with a staggered installation.



Rockfon Universal Baffle fixed in a Support Track.



Dimples on the end of the baffles to ensure good alignment.

1. Rockfon Baffle Support Track Solution

System components and consumption guide*

Baffle	Dimensions (mm)	Packing	Weight	Baffle row distance**		
				1200	600	300
Rockfon Universal Baffle 4F	1200 x 600 x 50	6 pcs/box	24,0 kg/box	0,69 pcs/m ²	1,39 pcs/m ²	2,78 pcs/m ²
	1200 x 450 x 50	6 pcs/box	19,2 kg/box			
	1200 x 300 x 50	12 pcs/box	30,3 kg/box			
	1800 x 600 x 50	6 pcs/box	33,5 kg/box	0,46 pcs/m ²	0,93 pcs/m ²	1,85 pcs/m ²
	1800 x 300 x 50	12 pcs/box	18,0 kg/box			
Rockfon Universal Baffle 2F	1200 x 600 x 50	6 pcs/box	20,2 kg/box	0,69 pcs/m ²	1,39 pcs/m ²	2,78 pcs/m ²
	1200 x 450 x 50	6 pcs/box	14,2 kg/box			
	1200 x 300 x 50	12 pcs/box	20,9 kg/box			
Accessories						
① Rockfon Baffle Support Track, 1,0 mm Galva	3000 x 30 x 30	8 pcs/box	25 kg/box	0,28 pcs/m ²	0,56 pcs/m ²	1,11 pcs/m ²
② Rockfon Baffle Support Track, 1,0 mm, White	3000 x 30 x 30	8 pcs/box	25 kg/box			
③ Rockfon Baffle Support Track, 1,0 mm, Black	3000 x 30 x 30	8 pcs/box	25 kg/box			
④ Rockfon Baffle Fixing Clip + M6 socket bolt		24 pcs/box	0,4 kg/box	2 pcs/baffle		
⑤ Rockfon Baffle Support Track Coupling***		48 pcs/box	1,5 kg/box	1 pc/Support Track		
⑥ Rockfon Baffle Support Track End Stop***		48 pcs/box	0,7 kg/box	2 pc/row		

* For baffles in parallel rows, no gaps.

** Center distance between baffles' rows (mm).

*** Only if required.

Accessories

1. Rockfon Baffle Support Track, Galva



2. Rockfon Baffle Support Track, White



3. Rockfon Baffle Support Track, Black



4. Rockfon Baffle Fixing Clip + M6 socket bolt



5. Rockfon Baffle Support Track Coupling



6. Rockfon Baffle Support Track End Stop



1. Rockfon Baffle Support Track Solution

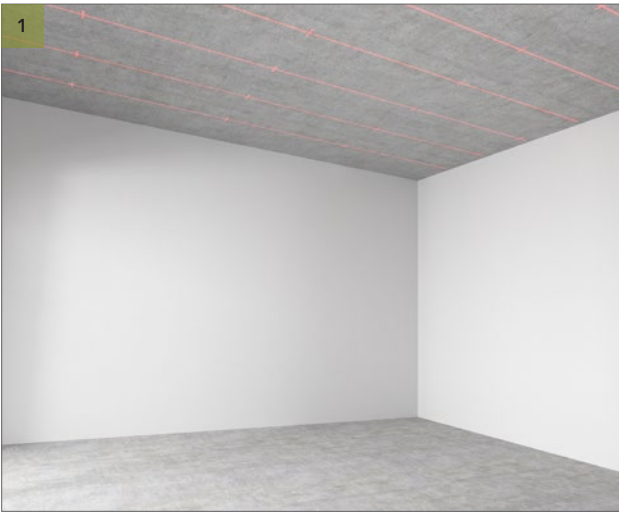

Use a laser to symmetrically mark drilling points in straight lines. Mark your drilling points on the soffit, at the ends of the Support Track and one in the middle.



Drill holes for the Support Track. Use fixings that are appropriate for the soffit.



Fix the Support Tracks to the soffit and level them properly. When necessary consider a use of flexible gaskets, e.g. rubber or foam gaskets, between Support Track and soffit – to compensate for uneven soffit surface and level Support Tracks. Remember to use fixings that are appropriate for the soffit. If required, use End Stop at the end of Support Track.

Note: if the Support Track is not level, the baffles are not level either!

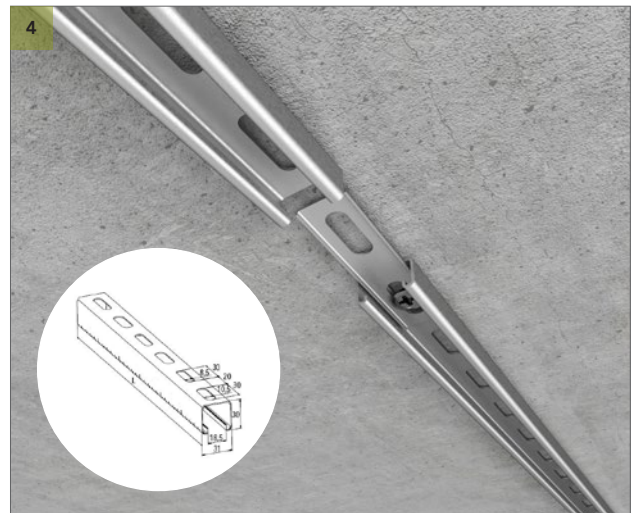

If required, use Rockfon Baffle Support Track Couplings when installing multiple lengths of Track. When using the Coupling, only one fixing point in the connector is needed instead of two.

1. Rockfon Baffle Support Track Solution



Connect a fixing clip to both ends of baffles using a hexagonal key and M6 socket bolt. Ensure that the clips are located parallel to the length of the baffle.



Attach the baffles to the Support Track. It is secure when you hear "click".



Fix baffles in the Support Track in the right position, as required. It is possible to 'fine tune' baffle position later.

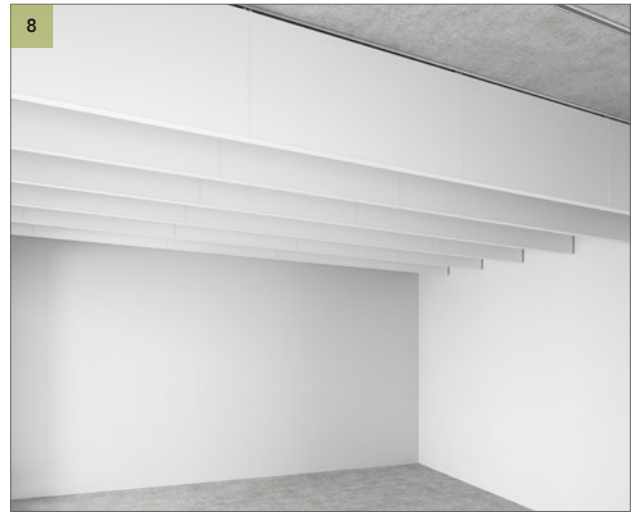

Install remaining Rockfon Universal Baffles and remember to use the dimples on the ends of the baffles to ensure alignment.

2. Rockfon Baffle T24 Solution

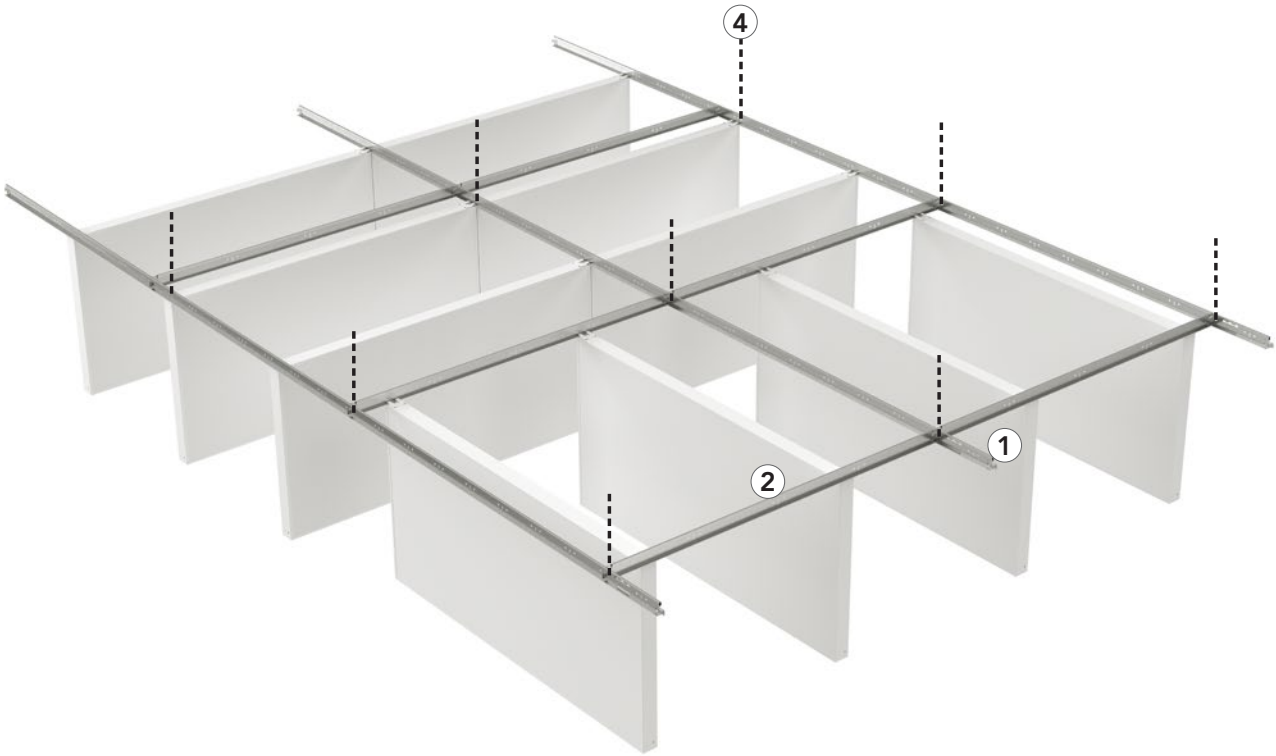

Rockfon Universal Baffle fixed to a Chicago Metallic T24 profile.



Rockfon Universal Baffle fixed between Chicago Metallic T24 profiles.



Dimples on the end of the baffles to ensure good alignment.

2. Rockfon Baffle T24 Solution

System components and consumption guide*

Baffles	Dimensions (mm)	Packing	Weight	Baffle row distance**		
				1200	600	300
Rockfon Universal Baffle 4F	1200 x 600 x 50	6 pcs/box	24,0 kg/box	0,69 pcs/m ²	1,39 pcs/m ²	2,78 pcs/m ²
	1200 x 450 x 50	6 pcs/box	19,2 kg/box			
	1200 x 300 x 50	12 pcs/box	30,3 kg/box			
	1800 x 600 x 50	6 pcs/box	33,5 kg/box	0,46 pcs/m ²	0,93 pcs/m ²	1,85 pcs/m ²
	1800 x 300 x 50	12 pcs/box	18,0 kg/box			
Rockfon Universal Baffle 2F	1200 x 600 x 50	6 pcs/box	20,2 kg/box	0,69 pcs/m ²	1,39 pcs/m ²	2,78 pcs/m ²
	1200 x 450 x 50	6 pcs/box	14,2 kg/box			
	1200 x 300 x 50	12 pcs/box	20,9 kg/box			
Chicago Metallic T24 Click 3830 and accessories				Consumptions (1200 mm Baffles)		
① Main runner T24 Click 3600	3600 (1200 mm centres)	20 pcs/box	21 kg/box	0,83 lm/m ²	0,83 lm/m ²	0,83 lm/m ²
② Cross tee T24 Click 1200		60 pcs/box	16,7 kg/box	0,83 lm/m ²	0,83 lm/m ²	0,83 lm/m ²
④ Quick-hangers HH 320		100 pcs/box	30 kg/box	0,69 pcs/m ²	0,69 pcs/m ²	0,69 pcs/m ²
Chicago Metallic T24 Click 3830 and accessories				Consumption (1800 mm Baffles)		
① Main runner T24 Click 3600	3600 (1800 mm centres)	20 pcs/box	21 kg/box	0,56 lm/m ²	0,56 lm/m ²	0,56 lm/m ²
③ Cross tee T24 Click 1800		60 pcs/box	16,7 kg/box	0,83 lm/m ²	0,83 lm/m ²	0,83 lm/m ²
④ Quick-hangers HH 320		100 pcs/box	30 kg/box	0,46 pcs/m ²	0,46 pcs/m ²	0,46 pcs/m ²

* For Baffles in parallel rows, no gaps.

** Center distance between Baffles' rows (mm).

Chicago Metallic T24 Click 3830

1. Main runner T24 Click 3600



2. Cross tee T24 Click 1200



3. Cross tee T24 Click 1800



Accessories

4. Quick hanger



2. Rockfon Baffle T24 Solution

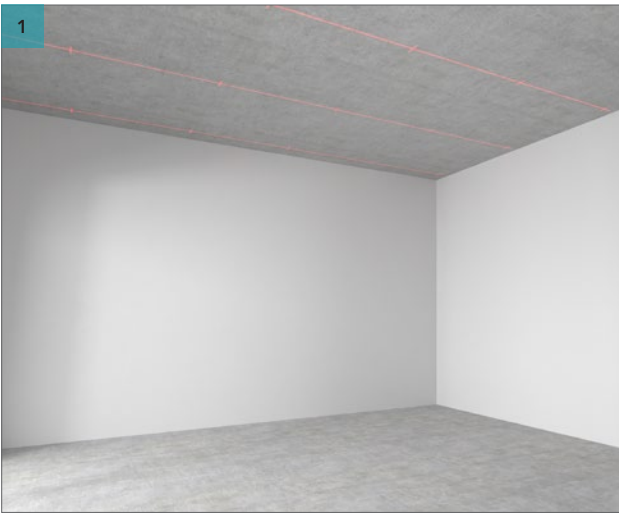

Use a laser to symmetrically mark drilling points in a straight line. Mark drilling points every 1200 mm on the soffit, in both length and width.



Drill where you have marked drilling points.



Use fixings that are appropriate for the soffit. Insert a screw eye into the soffit.



Attach quick-hangers (or rigid angle hangers) to the screw eyes and remember to secure them by closing the upper hook. Alternative suspension hangers can be used.

2. Rockfon Baffle T24 Solution



Attach main runner T24 3600 to the bottom of the quick-hangers and remember to secure them by closing the lower hook.



Install cross tee Click T24 1200 mm to main runners every 1200 mm.

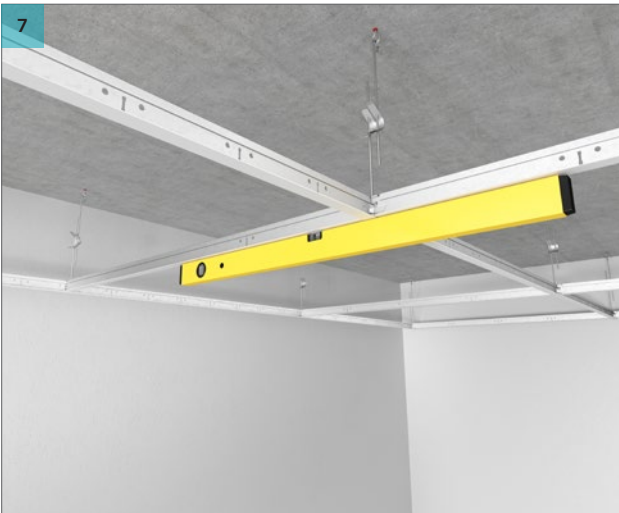

Adjust the level of the T24 profiles by using the quick-hangers' springs. Ensure the grid is leveled before installing baffles.
Note: if the T24 grid is not level, the baffles are not level either!



Fix the Rockfon Universal Baffle to the suspended Chicago Metallic T24 grid.

2. Rockfon Baffle T24 Solution



Fix Rockfon Universal Baffles to the suspended T24 profiles. You can use the slots of the T24 profiles to align the Rockfon Universal Baffles.



Rockfon Universal Baffles suspended between T24 profiles.



Fix the remaining Rockfon Universal Baffles to the T24 grid and align them using the dimples on the end of the baffles.

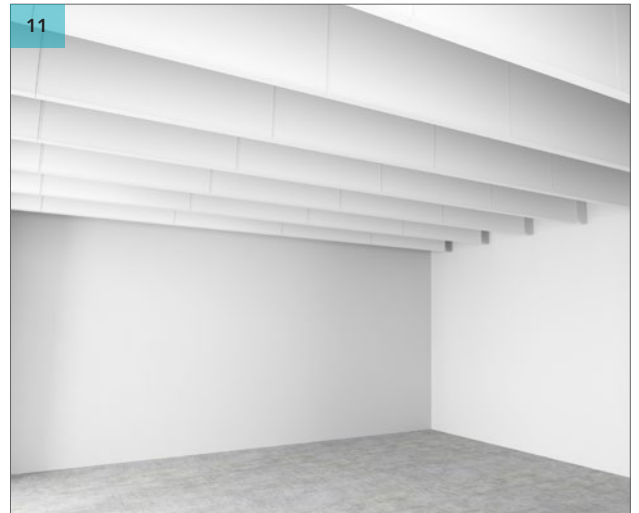

Fix all the remaining Rockfon Universal Baffles in the room.

3. Rockfon Baffle Design/Classic Suspension Sets Solution

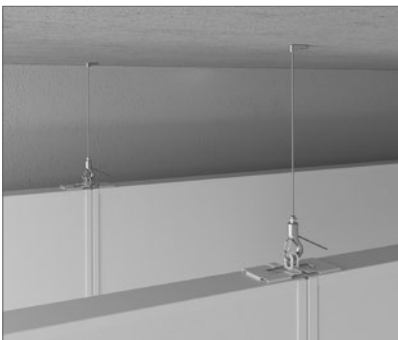

Baffles in rows – common suspension for two Rockfon Baffles in a row.



Rockfon Universal Baffles – suspension eyelet opened to vertical position.

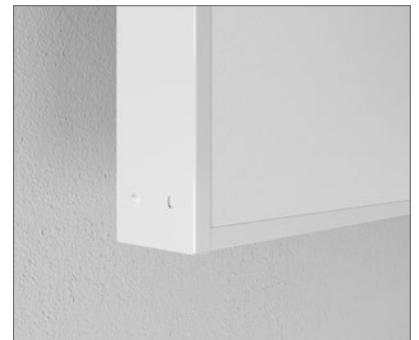

Dimples on the end of the baffles to ensure good alignment.

3. Rockfon Baffle Design/Classic Suspension Sets Solution

System components and consumption guide*

Baffles	Dimensions (mm)	Packing	Weight	Baffle row distance**		
				1200	600	300
Rockfon Universal Baffle 4F	1200 x 600 x 50	6 pcs/box	24,0 kg/box	0,69 pcs/m ²	1,39 pcs/m ²	2,78 pcs/m ²
	1200 x 450 x 50	6 pcs/box	19,2 kg/box			
	1200 x 300 x 50	12 pcs/box	30,3 kg/box			
	1800 x 600 x 50	6 pcs/box	33,5 kg/box	0,46 pcs/m ²	0,93 pcs/m ²	1,85 pcs/m ²
	1800 x 300 x 50	12 pcs/box	18,0 kg/box			
Rockfon Universal Baffle 2F	1200 x 600 x 50	6 pcs/box	20,2 kg/box	0,69 pcs/m ²	1,39 pcs/m ²	2,78 pcs/m ²
	1200 x 450 x 50	6 pcs/box	14,2 kg/box			
	1200 x 300 x 50	12 pcs/box	20,9 kg/box			
Accessories						
① Rockfon Baffle Design Suspension Set		12 pcs/box	0,7 kg/box	1 pc/baffle + 1 pc/row		
② Rockfon Baffle Classic Suspension Set		12 pcs/box	0,6 kg/box	1 pc/baffle + 1 pc/row		

* For baffles in parallel rows, no gaps.

** Center distance between baffles' rows (mm).

Accessories

1. Design Suspension Set



2. Classic Suspension Set



3. Rockfon Baffle Design/Classic Suspension Sets Solution

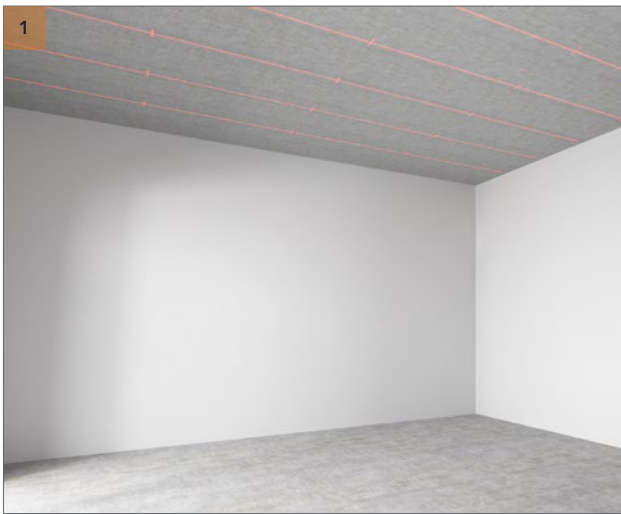

Use a laser to symmetrically mark drilling points in a straight line. Mark drilling points every 1200 mm on the soffit.



Drill where you have marked drilling points.

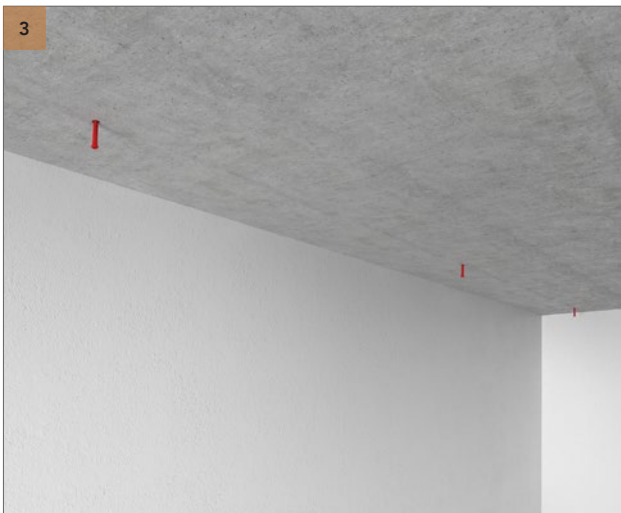

Use fixings that are appropriate for the soffit.

3. Rockfon Baffle Design/Classic Suspension Sets Solution

4 - Design Suspension Set



Fix the Rockfon Baffle Design Suspension Set's upper part (the one with external M13 thread) to the soffit. Use the fixing screws appropriate to soffit's material and small enough for Rockfon Baffle Design Suspension Sets cylindrical cover (max. head diameter 12 mm) – use symbol of diameter.

5a - Design Suspension Set



Slide the wire cable from the Design Suspension Set through cylindrical cover, so the eyelet cable end is hidden inside. Screw it onto the M13 thread. You can attach the adjustable hook to bottom end of the wire cable.

5b - Classic Suspension Set

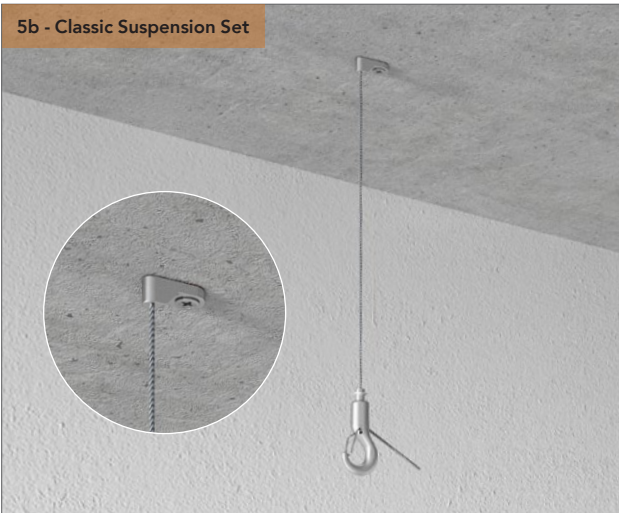

Fix the cable end with 6,5 mm eyelet to the soffit by fixing screw. You can attach the adjustable hook to the bottom end of the wire cable.

6

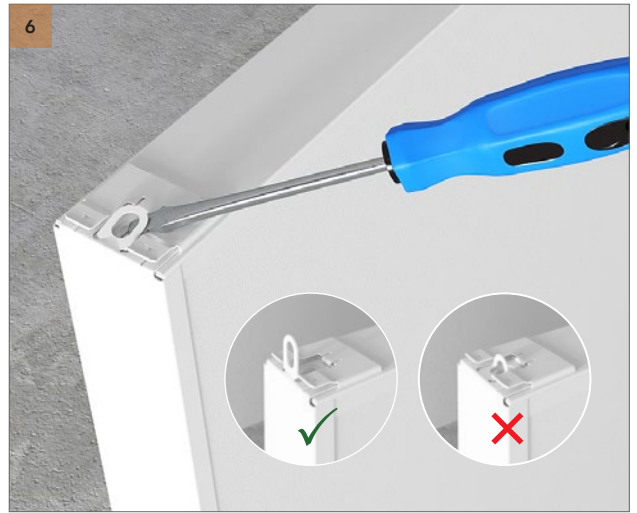

Lift up the flat eyelet on the top of the Rockfon Universal Baffle. **Note: Ensure the eyelet is completely vertical.**

3. Rockfon Baffle Design/Classic Suspension Sets Solution

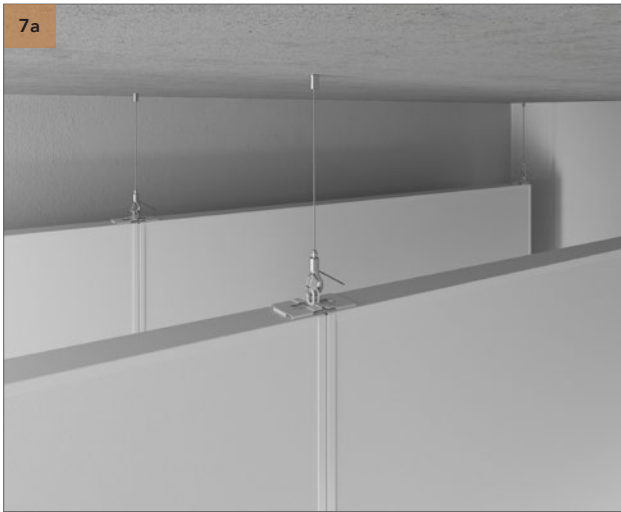

Connect the Rockfon Universal Baffles to the suspension sets by using the adjustable hook.



Place a level on top or underneath the baffles to ensure their evenness. Levelling can be done by releasing the lock on the hook and pulling on the wire rope.

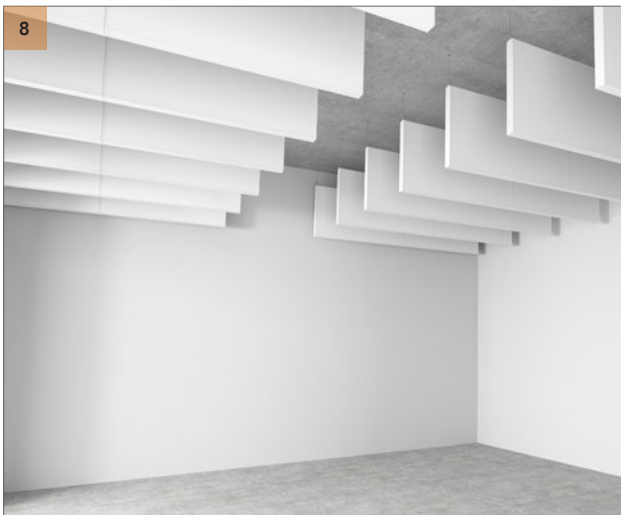

Fix all remaining Rockfon Universal Baffles and align them in rows using the dimples on the sides of the baffles.

General installation recommendations

Safe and levelled soffit structure

Always ensure that the soffit structure is solid and that it has a minimum load bearing capacity of 10 kg per suspension point. Make sure that the soffit surface is even. If not, ensure that you level out the surface of the soffit if necessary before installing Rockfon Baffles solutions.

Suspension grid

Unless specified otherwise, the ceiling should be set out symmetrically and where possible the hangers should be fastened with appropriate top fixings to the main runners at 1200 mm centres (or less with greater load).

Main runners should be positioned at 1200 mm centres for 1200 mm long baffles.

For 1800 x 600 mm module sizes it's only possible to click the baffles on the main runners, when installing them perpendicular to the main runners. This means that for module 1800 x 600 mm the main runners should be positioned at 1800 mm centres.

For proper grid installation, ensure that the T profiles are perfectly aligned, horizontally and that the diagonals of the modules are equal. Main runner joints should be staggered and there should be a hanger positioned within 150 mm of the fire expansion element/ cut-out and within 450 mm of the end of the main runner where it terminates at a perimeter.

Additional hangers may be necessary to support the weight of ceiling services.

Baffles

It is recommended to use clean nitrile or PU coated gloves when installing Rockfon Baffles in order to avoid finger prints and pollution of the surface.

For an optimised work environment, we recommend installers always observe common work practices and follow the installation advise as shown on our packaging.

Tools

Rockfon has developed specific tools that are available on www.rockfon.asia

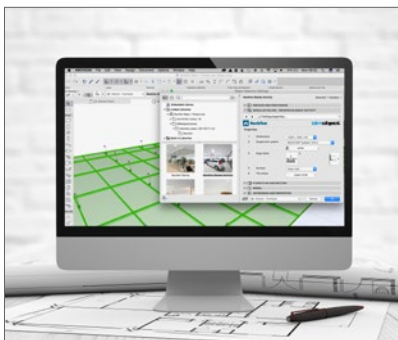

Visit our online CAD Library or BIM portal to assist you in your project design.

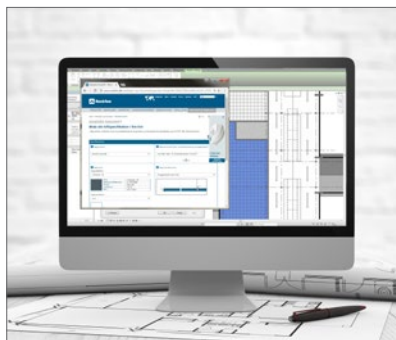

Generate specification texts for our products on our website.



Explore our vast library of reference projects on our website.

Rockfon® is a registered trademark
of the ROCKWOOL Group.

06.2021 | All colour codes mentioned are based on the NCS - Natural Colour System® property of and used on license from NCS Colour AB, Stockholm 2012 or the RAL colour standard. Subject to alterations in range and product technology without prior notice. Rockfon accepts no responsibility for printing errors.

Sounds Beautiful

Rockfon Singapore

ROCKWOOL Building Materials
(Singapore) Pte Ltd.
No. 7, Tuas Avenue 1
Jurong Town,
Singapore 639492
Tel: (+65) 6861 4722
Fax: (+65) 6862 3533
E-mail: enquiry@rockfon.com
www.rockfon.asia

Rockfon Hong Kong

ROCKWOOL Building Materials
(Hong Kong) Ltd.
Unit 301-2, 3/F, Koon Wah Building,
No.2 Yuen Shun Circuit,
Yuen Chau Kok, Shatin,
N.T., Hong Kong
Tel: (+852) 2576-6117
Mobile: (+852) 9161-7924
E-mail: enquiry@rockfon.com
www.rockfon.asia

Rockfon

ROCKWOOL Middle East FZE
Office 139, Building 6WB, DAFZA
P. O. Box 293585, Dubai, UAE

Tel: +971-4-214-6280
E-mail: rockfonme@rockfon.com
ae.rockfon.com

Rockfon

ROCKWOOL France S.A.S.
111, rue du Château des Rentiers
75013 Paris

Tel: +33 1 40 77 82 82
Fax.: +33 1 45 86 77 90
E-mail: info@rockfon.fr
www.rockfon.fr

